

SynQor[®]

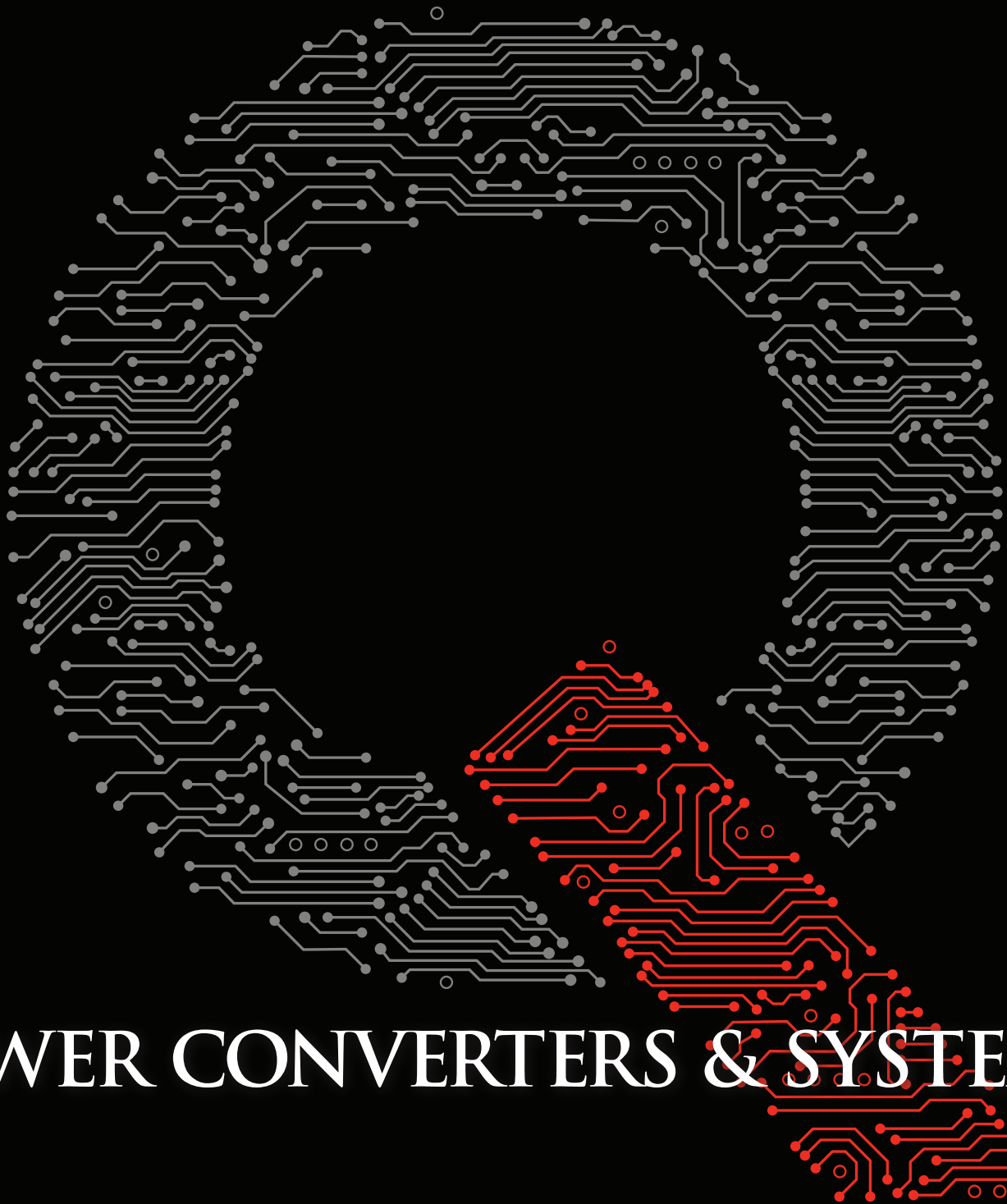

POWER CONVERTERS & SYSTEMS

Contents

Military Products

MilQor® MilCOTS Converters & Filters

Military Isolated DC-DC Converters	4
Military DC Filters	8
Military AC Line Filters	9
Military Power Factor Correction Modules	10
Military Isolated Power Factor Correction Modules.....	11
Military 3-Phase Power Factor Correction Modules.....	12
Military 3-Phase Isolated PFC Modules	14
Military 3-Phase AC Line Filters	15
Military DC-DC Bus Converters.....	16
Military High Voltage Non-Isolated DC-DC Converters.....	17
Military Quad Output Non-Isolated DC-DC Converters.....	18

MilQor Hi-Rel Converters & Filters

Hi-Rel Converters	19
Hi-Rel Filters.....	23
Hi-Rel Screening	24

MilQor Power Systems

UPS Uninterruptible Power Supplies.....	25
MPC Military Power Conditioners	35
MPS Military Power Supplies	41
MPPS Military Programmable Power Supplies.....	41
MINV Military Power Inverter.....	45
MAC Military AC Phase/Frequency Changer	47
VPX Military Field-Grade Power Supplies.....	49
Configurable Multi-Output DC-DC & AC-DC Power Supplies.....	54

Avionics Products

AeroQor®

AeroQor Single-Phase Power Factor Correction Modules.....	60
AeroQor Single-Phase AC Line Filters.....	61
AeroQor 3-Phase Power Factor Correction Modules	62
AeroQor 3-Phase AC Line Filters	63

Transportation Products

RailQor®

Railway Isolated DC-DC Converters	64
---	----

Industrial Products

InQor® Power Converters

Industrial DC-DC Power Converters	68
---	----

DC Filters

Industrial DC Filters	74
-----------------------------	----

NiQor® (High-Voltage) Non-Isolated DC-DC Converters

Single Output, Non-Isolated Converters	75
--	----

PFCQor®

Power Factor Correction Modules.....	77
--------------------------------------	----

PFICQor

Isolated Power Factor Correction Modules	78
--	----

AC-DC Power Supplies

Industrial AC-DC Power Supplies	80
---------------------------------------	----

Telecom / Datacom Products

PowerQor® and DualQor®

Single and Dual Output, Isolated Converters	81
---	----

BusQor®

Single Output, Isolated Bus Converters.....	85
---	----

NiQor®

Single Output, Non-Isolated Converters	87
--	----

iQor

*ATCA® Interface Modules	89
--------------------------------	----

Medical Products

CFQor

Medical-Grade DC-DC Converters.....	90
-------------------------------------	----

ACuQor®

Medical-Grade AC-DC Supplies with PFC	91
---	----

Mechanicals & Accessories

ACuQor Mechanical Diagrams.....	92
Open Frame Mechanical Diagrams	94
Encased Package Dimensions.....	95
Hi-Rel Package Dimensions	97
Accessories	99

Product Development & Manufacturing

Process	101
---------------	-----

SynQor is a leading supplier of **power conversion solutions** to the military, avionics, transportation, medical, industrial, telecommunications and computing markets.

SynQor's innovative products are designed to exceed the demanding performance, quality, and reliability requirements of today's power electronic engineers who develop leading-edge infrastructure hardware.

SynQor provides all the **power conversion modules** needed to build a power system solution, as well as complete **power systems**.

SynQor's core capabilities include both standard and custom solutions, delivered with industry leading service and support.

SynQor's total commitment to quality, customer satisfaction and continuous improvement drives our business processes.

SynQor products have been given the classification EAR99 under the Export Administration Regulations (EAR) and will not generally require a license to be exported.



POWER CONVERTERS & SYSTEMS

Broad and Scalable Product Line

Hi-Rel Products

High-Reliability, Field Proven DC-DC Converters for Military/Aerospace applications

- -55 °C to +125 °C full power operational temperature
- Input voltage ranges from 5.5 V to 475 V
- No opto-isolators
- Non-hybrid, SMT construction
- Conduction cooled QorSeal® packaging

Military Power Systems

- Designed for the extreme environmental and demanding electrical conditions of military applications
- Product line includes MPC Military Power Conditioners, MPS Military Power Supplies, MINV Military Power Inverter, MAC Military AC Changers, VPX Military Field-Grade DC-DC, & AC-DC Power Supplies, Configurable Multi-Output DC-DC & AC-DC Power Supplies & Uninterruptible Power Supplies

Mil-COTS Products

Mil-COTS Converters for Military applications

- -55 °C to +100 °C full power operational temperature
- DC input voltage ranges from 9.0 V to 1000 V
- AC-DC Power Factor Correction Modules
- Conduction cooled, ruggedized package



Transportation Products

- Railway Transportation DC-DC Converters
- High efficiency in zero airflow

Avionics Products

- Avionics Isolated Power Factor Correction Modules & Filters
- Designed to be used as a COTS Component in airborne applications

Industrial Products

- Power Converters designed to be used in a wide range of industrial applications including those required to withstand harsh environments
- Product line includes: Isolated DC-DC Power Converters, DC Filters, AC-DC Power Supplies, Non-Isolated DC-DC Converters, Power Factor Correction Modules, and AC Line Filters

Medical Power Supplies

- Designed to meet an extensive range of Medical applications
- Medical-Grade DC-DC Converters
- Medical-Grade AC-DC Supplies with PFC

Telecom / Datacom Converters

- Single and Dual Output, Isolated Converters
- Single Output, Isolated Bus Converters
- Single Output, Non-Isolated Converters
- ATCA® Interface Modules

Advancing The Power Curve®

SynQor®

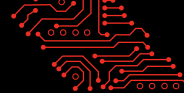

MilCOTS™ Isolated Converters

Mil-COTS DC-DC Converters for Military/Aerospace Applications

The MilQor® series of Mil-COTS Isolated DC-DC converters brings SynQor's field proven high-efficiency synchronous rectifier technology to the Military/Aerospace industry. These "off-the-shelf" converters are compatible with the industry standard format, operate at a fixed frequency, and follow conservative component derating guidelines. MilQor products are designed and manufactured to comply with a wide range of military standards.

MCOTS Product Features

- High efficiency, up to 95% at full rated load current
- Fixed frequency switching provides predictable EMI
- No minimum load requirement
- Rugged design for harsh environments
- Full Feature option on some models
- Flanged baseplate available
- Industry standard pin-out configurations and standard footprints.
- Available: High-capacitance option for very large output capacitance and extreme transient applications
- -55 °C to +100 °C Operating Temperature

Compliance Features

Mil-COTS converters with Mil-COTS filters are designed to meet:

- MIL-HDBK-704
- RTCA/DO-160 Section 16, 17, 18
- MIL-STD-1275
- MIL-STD-461
- DEF-STAN 61-5 (part 6)/(5, 6)

Protection

- Input under-voltage lockout
- Output current limit and short circuit protection
- Active back bias limit
- Output over-voltage protection
- Thermal shutdown (not on DM Package Size)

Control

- On/Off control referenced to input side (Fully isolated Full Bricks)
- Remote sense for the output voltage
- Digital Output Current Sharing (HZ only)
- Output voltage trim range of:

(Half-Brick Zeta)	+10% to -20%
(Quarter-Brick Exa)	+10% to -50%
(Sixteenth Brick)	+10% to -10%

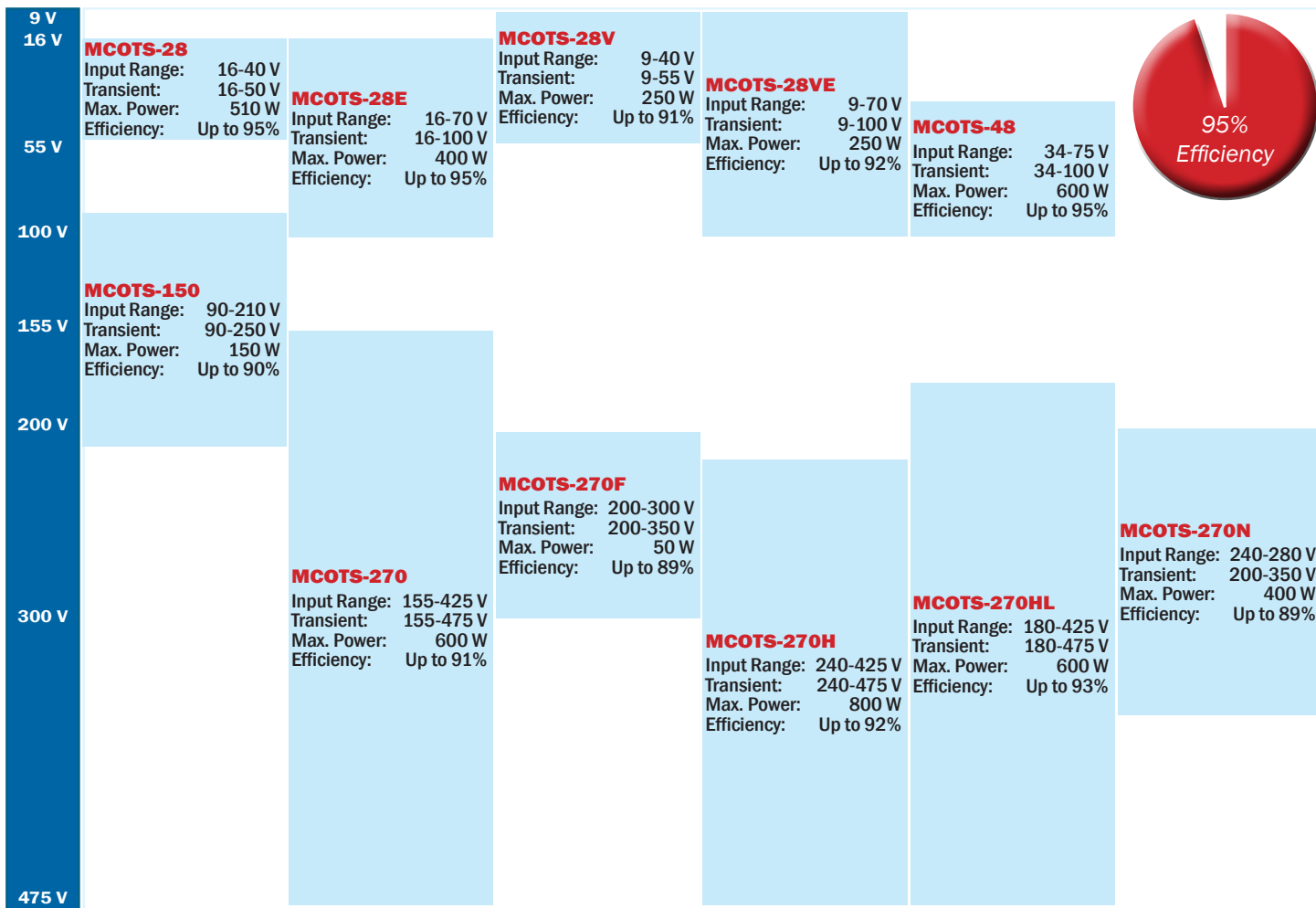

Mil-COTS DC-DC Converters

Family	Product	Cont. Input Voltage	Output Voltage		Package Size/ (Performance Level)	Heatsink Option	Screening Level	Options
MCOTS	C: Converter	28: 16-40 V	1R2: 1.2 V	12: 12 V	FZ: Full Brick (Zeta)	N: Encased, Baseplate D: Encased, Non-Threaded Baseplate F: Encased, Flanged Baseplate	S: S-Grade M: M-Grade	[]: Standard F: Full Feature C: High-Capacitance FC: High-Capacitance & Full Feature
		28E: 16-70 V	1R5: 1.5 V	15: 15 V	FE: Full Brick (Exa)			
		28V: 9-40 V	1R8: 1.8 V	24: 24 V	FP: Full Brick (Peta)			
		28VE: 9-70 V	2R5: 2.5 V	28: 28 V	FT: Full Brick (Tera)			
		48: 34-75 V	3R3: 3.3 V	36: 36 V	HY: Half Brick (Yota)			
		150: 90-210 V	05: 5.0 V	40: 40 V	HZ: Half Brick (Zeta)			
		270: 155-425 V	07: 7.0 V	48: 48 V	HE: Half Brick (Exa)			
		270F: 200-300 V	7R5: 7.5 V	50: 50 V	HP: Half Brick (Peta)			
		270HL: 180-425 V	08: 8.0 V	135: 135 V	HT: Half Brick (Tera)			
		270H: 240-425 V	10: 10 V	270: 270 V	QE: Quarter Brick (Exa)			
270N: 240-280 V			QT: Quarter Brick (Tera)					
			SG: Sixteenth Brick (Giga)					
			SK: Sixteenth Brick (Kilo)					
			DM: Demi Brick (Mega)					

Example: MCOTS-C-28-05-HP-N-M For valid part numbers, refer to the website or contact your local sales representative.

See "Encased Package Configurations" on page 95 for package outlines.



MCOTS-28		Vout	1.8 V	3.3 V	5 V	7 V	12 V	15 V	24 V	28 V	40 V	48 V	50 V	135 V	270 V
16-40 Vin Cont. 50 Vin 1s Trans. Absolute Max Vin = 60 V	FULL ZETA														3.7 A 999 W
	1/2 ZETA			60 A 300 W		42 A 504 W	34 A 510 W	21 A 504 W	18 A 504 W	12.5 A 500 W		10 A 500 W	3.7 A 500 W		
	1/2 PETA	60 A 108 W	50 A 165 W	40 A 200 W		16 A 192 W	13 A 195 W	8 A 192 W	7 A 196 W	5 A 200 W	4 A 192 W				
	1/4 EXA			40 A 200 W		25 A 300 W	20 A 300 W		10.7 A 300 W				6 A 300 W		
	1/4 TERA	40 A 72 W	30 A 99 W	24 A 120 W	17 A 119 W	10 A 120 W	8 A 120 W	5 A 120 W	4 A 112 W		2.5 A 120 W				
	1/16 GIGA		15 A 50 W	10 A 50 W	7 A 49 W	4 A 48 W	3.3 A 50 W	2 A 48 W	1.8 A 50 W		1.04 A 50 W				

Single Output

Dual Output

MCOTS-28 Demi		Vout	3.3 V	5.0 V	12 V	15 V	28 V	±5.0 V	±12 V	±15 V
16-40 Vin Cont. 50 Vin 1s Trans. Absolute Max Vin = 60 V	DEMI	15 A	10 A	4.0 A	3.3 A	1.8 A	10 A	4 A	3.3 A	
	MEGA	50 W	50 W	48 W	50 W	50 W	50 W Total	48 W Total	50 W Total	

MCOTS-28E		Vout	5 V	9.6 V	12 V	28 V	50 V
16-70 Vin Cont. 100 Vin 1s Trans. Absolute Max Vin = 100 V	1/2 ZETA	60 A 300 W	42 A 403 W	33 A 396 W	14 A 392 W	8 A 400 W	

MCOTS-28E Demi		Vout	5 V
16-70 Vin Cont. 100 Vin 1s Trans. Absolute Max Vin = 100 V	DEMI	10 A	10 A
	BRICK	50 W	50 W

MCOTS-28V		Vout	3.3 V	5 V	7 V	12 V	15 V	24 V	28 V	48 V	50 V
9-40 Vin Cont. 55 Vin 1s Trans. Absolute Max Vin = 60 V	1/2 YOTA					42 A 504 W			18 A 504 W		
	1/2 ZETA			50 A 250 W		21 A 252 W	17 A 255 W	10 A 240 W	9 A 252 W		5 A 250 W
	1/2 PETA			36 A 180 W		15 A 180 W	12 A 180 W	7.5 A 180 W	6.5 A 182 W	3.7 A 178 W	
	1/4 TERA	25 A 83 W	17 A 85 W	12 A 84 W	7 A 84 W	5.5 A 83 W	3.5 A 84 W	2.8 A 78 W			

MCOTS-28VE		Vout	3.3 V	5 V	7 V	12 V	15 V	24 V	28 V	40 V	48 V	50 V
9-70 Vin Cont. 100 Vin 1s Trans. Absolute Max Vin = 100 V	1/2 ZETA			50 A 250 W		21 A 252 W	17 A 255 W	10 A 240 W	9 A 252 W	6 A 240 W		5 A 250 W
	1/2 PETA	45 A 149 W				13 A 156 W			5.8 A 162 W		3.4 A 163 W	
	1/4 TERA	25 A 83 W	17 A 85 W	12 A 84 W	7 A 84 W	5.5 A 83 W	3.5 A 84 W	2.8 A 78 W			1.8 A 86 W	

MCOTS-48		Vout	1.8 V	3.3 V	5 V	7 V	12 V	15 V	24 V	28 V	30 V	40 V	48 V	50 V
34-75 Vin Cont. 100 Vin 1s Trans. Absolute Max Vin = 100 V	1/2 ZETA			60 A 300 W		50 A 600 W	40 A 600 W	25 A 600 W	21.5 A 602 W			15 A 600 W		12 A 600 W
	1/2 PETA			60 A 198 W	46 A 230 W		21 A 252 W	17 A 255 W	10.5 A 252 W	9 A 252 W			5.2 A 250 W	
	1/4 TERA			30 A 99 W	25 A 125 W	20 A 140 W	12 A 144 W	10 A 150 W	6 A 144 W		5 A 150 W		3 A 144 W	
	1/16 GIGA	25 A 45 W	15 A 50 W	10 A 50 W	7 A 49 W	4 A 48 W	3.3 A 50 W		1.8 A 50 W				1.04 A 50 W	

MCOTS-150		Vout	5 V	28 V	48 V
90-210 Vin Cont. 250 Vin 1s Trans. Absolute Max Vin = 250 V	1/4 TERA	30 A 150 W	5.35 A 150 W	3.1 A 149 W	

MCOTS-270

	Vout	3.3 V	5 V	6 V	12 V	15 V	24 V	28 V	40 V	48 V	60 V
155-425 Vin Cont. 475 Vin 1s Trans. Absolute Max Vin = 600 V	FULL EXA								60 A 1000 W		40 A 1000 W
	FULL TERA		80 A 400 W		50 A 600 W	40 A 600 W	25 A 600 W	21.4 A 599 W		12.5 A 600 W	
	1/2 EXA								35 A 600 W		25 A 600 W
	1/2 TERA	60 A 198 W	50 A 250 W	33 A 198 W	25 A 300 W	20 A 300 W	12.5 A 300 W	10.7 A 300 W		6.3 A 302 W	
	1/4 TERA	30 A 99 W	30 A 150 W	25 A 150 W	13 A 156 W	10 A 150 W	6.25 A 150 W	5.35 A 150 W		3.1 A 149 W	

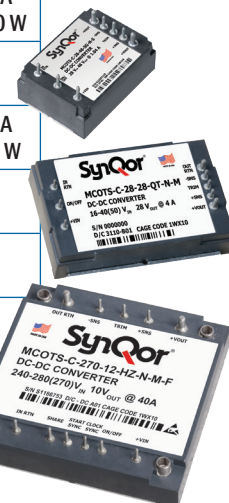

MCOTS-270

	Vout	5 V	12 V	28 V	48 V
230-425 Vin Cont. 475 Vin 1s Trans. Absolute Max Vin = 600 V	1/2 PETA	70 A 350 W	42 A 500 W	18 A 500 W	10.4 A 500 W

MCOTS-270N

	Vout	8 V	10 V	12 V	28 V
240-280 Vin Cont. 200-350 Vin 100ms Trans. Absolute Max Vin = 600 V	1/2 TERA	50 A 400 W	40 A 400 W	33 A 396 W	14.5 A 406 W

MCOTS-270F

	Vout	3.3 V	5 V	12 V	28 V
200-300 Vin Cont. 350 Vin 1s Trans. Absolute Max Vin = 500 V	1/16 KILO	7.5 A 25 W	5 A 25 W	2.1 A 25 W	0.9 A 25 W
	DEMI MEGA	15 A 50 W	10 A 50 W	4 A 48 W	1.8 A 50 W

MCOTS-270H

	Vout	5 V	6 V	7 V	12 V	28 V	36 V
240-425 Vin Cont. 475 Vin 1s Trans. Absolute Max Vin = 600 V	FULL PETA	100 A 500 W	110 A 660 W	90 A 630 W	66.7 A 800 W	28.6 A 800 W	22.2 A 800 W

MCOTS-270HL

	Vout	36 V
180-425 Vin Cont. 475 Vin 1s Trans. Absolute Max Vin = 600 V	FULL BRICK TERA	16.7 A 600 W

Product Screening

SCREENING	Process Description	S-Grade	M-Grade
Baseplate Operating Temperature		-55 °C to +100 °C	-55 °C to +100 °C
Storage Temperature		-65 °C to +135 °C	-65 °C to +135 °C
Pre-Cap Inspection	IPC-A-610 Class III	•	•
Temperature Cycling	MIL-STD-883F, Method 1010, Condition B, 10 Cycles		•
Burn-In	100 °C Baseplate	12 hours	96 hours
Final Electrical Test	100%	25 °C	-55 °C, +25 °C, +100 °C
Final Visual Inspection	MIL-STD-883, Method 2009	•	•

Product Qualification

QUALIFICATION Test Name	Details	# Tested (# Failed)	Consistent with MIL-STD-883F Method
Life Testing	Visual, mechanical and electrical test before, during and after 1000 hour burn-in @ full load	15 (0)	Method 1005.8
Shock-Vibration	Visual, mechanical and electrical test before, during and after shock and vibration tests	5 (0)	MIL-STD 202, Methods 201 A and 213B
Humidity	+85 °C, 95% RH, 1000 hours, 2 minutes on 6 hours off	8 (0)	Method 1004.7
Temperature Cycling	500 cycles of -55 °C to +100 °C (30 minute dwell at each temperature)	10 (0)	Method 1010.8, Condition A
Solderability	15 pins	15 (0)	Method 2003
DMT	-65 °C to +110 °C across full line, and load specifications in 5 °C steps	7 (0)	—
Altitude	70,000 feet (21 km)	2 (0)	—



MilCOTS™

DC Filters

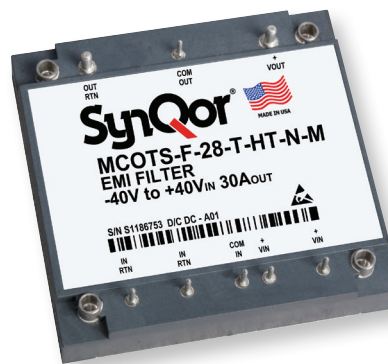

Mil-COTS DC Filter Modules

SynQor provides EMI filters for the MIL-COTS DC-DC converters. All EMI filters provide high levels of differential-mode and common-mode attenuation and include stabilizing bulk capacitors and damping resistors.

Filter Features

- Low DC resistance
- Differential-mode attenuation
- Common-mode attenuation
- Bulk capacitance provides input system stabilization for downstream power converters
- -55 °C to +100 °C Operating Temperature
- No electrolytic capacitors (all ceramic design)
- High-voltage isolation between common-mode pins and input / output
- Wide temperature range operation
- Designed to meet MIL-STD-461

Mil-COTS DC Filters

Family	Product	Vin Range	Filter Type	Package Size	Thermal Design	Screening Level
MCOTS	F: Filter	28: -40 V to +40 V 28E: -70 V to +70 V 48: -80 V to +80 V 270: -500 V to +500 V	P: Passive T: Transient	DM: Demi-brick Mega QT: Quarter-brick Tera HP: Half-brick Peta HT: Half-brick Tera	N: Encased, Threaded Baseplate D: Encased, Non-Threaded Baseplate F: Encased, Flanged Baseplate	S: S-Grade M: M-Grade

Example: MCOTS-F-28-T-HT-N-M For valid part numbers, refer to the website or contact your local sales representative.

DC Filter Model Number	Input Voltage		Output Current	Isolation Voltage (to common-mode)	Maximum DC Resistance @ 100 °C	Differential-Mode Attenuation	Common-Mode Attenuation
	Continuous	Surge (<100ms)					
HALF BRICK							
MCOTS-F-28-T-HP	±40 V	+100 V, -50 V	40 A	2250 V	40 mΩ	>80 dB @ 250 kHz	>36 dB @ 250 kHz
MCOTS-F-28-P-HP	±40 V	±40 V	70 A	2250 V	7 mΩ	>150 dB @ 250 kHz	>20 dB @ 250 kHz
MCOTS-F-28-T-HT	±40 V	+100 V, -50 V	30 A	2250 V	40 mΩ	>80 dB @ 250 kHz	>36 dB @ 250 kHz
MCOTS-F-270-P-HT	±500 V	±630 V	9 A	2500 V	106 mΩ	>70 dB @ 250 kHz	>50 dB @ 250 kHz
QUARTER BRICK							
MCOTS-F-28-P-QT	±40 V	±50 V	30 A	2250 V	20 mΩ	>80 dB @ 250 kHz	>36 dB @ 250 kHz
MCOTS-F-48-P-QT	±80 V	±100 V	20 A	2250 V	32 mΩ	>80 dB @ 250 kHz	>36 dB @ 250 kHz
MCOTS-F-270-P-QT	±500 V	±630 V	4.0 A	2500 V	180 mΩ	>80 dB @ 500 kHz	>50 dB @ 500 kHz
DEMI BRICK							
MCOTS-F-28-P-DM	±40 V	±50 V	10 A	1000 V	60 mΩ	>80 dB @ 500 kHz	>60 dB @ 500 kHz
MCOTS-F-28E-P-DM	±70 V	±100 V	10 A	1000 V	60 mΩ	>80 dB @ 500 kHz	>60 dB @ 500 kHz



MilCOTS™

AC Filters

Mil-COTS AC Line Filter Modules

SynQor provides AC Line filters for the Mil-COTS series of PFC modules and DC-DC converters. SynQor's high-performance filters are designed to comply with military EMI requirements.



Filter Features

- Universal Input voltage range
- 500 W @ 115 Vrms or 1 kW @ 230 Vrms (Eighth-Brick)
- 575 W @ 115 Vrms or 1.1 kW @ 230 Vrms (Quarter-Brick)
- 1 kW @ 115 V or 2 kW @ 230 V (Half-Brick)
- All ceramic capacitor design
- High voltage isolation between baseplate and input/output
- Internally damped
- -55 °C to +100 °C Operating Temperature
- Low power dissipation
- Complies with industry EMI standards when used with SynQor MPFC and DC-DC converter modules



Mil-COTS AC Line Filters

Family	Input Frequency	Vin Range	Package Size	Thermal Design	Screening Level
MACF	U: 50 / 60 Hz & 400 Hz 060: 50 / 60 Hz 400: 400 Hz	230: 85-264 Vrms	ET: Eighth-brick Tera QT: Quarter-brick Tera HT: Half-brick Tera HP: Half-brick Peta	N: Encased, Threaded Baseplate D: Encased, Non-Threaded Baseplate F: Encased, Flanged Baseplate	S: S-Grade M: M-Grade

Example: MACF-060-230-HT-N-M For valid part numbers, refer to the website or contact your local sales representative.

Model Number	Input Phase	Input Frequency	Input Voltage	Output Current	Output Power
MACF-U-230-ET	Single Phase	50 / 60 Hz & 400 Hz	85-264 VRMS	5 ARMS	500 W @ 115 VRMS / 1 kW @ 230 VRMS
MACF-U-230-QT	Single Phase	45 - 800 Hz	85-264 VRMS	5 ARMS	575 W @ 115 VRMS / 1.1 kW @ 230 VRMS
MACF-060-230-HT	Single Phase	50 / 60 Hz	85-264 VRMS	9 ARMS	1 kW @ 115 VRMS / 2 kW @ 230 VRMS
MACF-400-230-HT	Single Phase	400 Hz	85-264 VRMS	9 ARMS	1 kW @ 115 VRMS / 2 kW @ 230 VRMS
MACF-060-230-HP	Single Phase	50 / 60 Hz	85-264 VRMS	11.5 ARMS	1 kW @ 115 VRMS / 2 kW @ 230 VRMS
MACF-400-230-HP	Single Phase	400 Hz	85-264 VRMS	11.5 ARMS	1 kW @ 115 VRMS / 2 kW @ 230 VRMS



Mil-COTS Power Factor Correction Module

The MPFCQor Power Factor Correction module is an essential building block of an AC-DC power supply. Used in conjunction with a hold-up capacitor, SynQor's high efficiency MCOTS DC-DC converters and SynQor's MCOTS AC line filter, the MPFCQor will draw a nearly perfect sinusoidal current (PF>0.99) from a single phase AC input. The MPFCQor module can be paralleled to achieve higher power. The module is supplied completely encased to provide protection from the harsh conditions seen in many military and extreme environments.

Operational Features

- Universal input voltage range: 85-264 Vrms
- Narrow input voltage range: 85-180 Vrms
- Universal input frequency range: 47 - 63 Hz / 360 - 800 Hz
- Up to 700 W output power
- ≥0.99 Power Factor
- High efficiency: Up to 95% (115 Vrms)
- Internal inrush current limit
- Auxiliary 10 V bias supply
- 100 °C max baseplate temperature at full power
- -55 °C to +100 °C Operating Temperature
- Can be paralleled with current sharing
- Compatible with SynQor's MCOTS DC-DC Converters and SynQor's MCOTS AC line filters

Protection/Control Features

- PFC Enable
- Load Enable (also: Power Out Good signal)
- AC Power Good Signal (Half-Brick Only)
- Clock synchronization (Half-Brick Only)
- Output current monitor / current sharing (Half-Brick Only)
- Input current limit and auto-recovery short circuit protection
- Auto-recovery input under / over-voltage protection
- Auto-recovery output over-voltage protection
- Auto-recovery thermal shutdown



Mil-COTS Power Factor Correction Module

Family	Vin Range	Output Voltage	Package Size	Thermal Design	Screening Level
MPFC	U: 85-264 Vrms 115: 85-180 Vrms	270: 270 Vdc 390: 390 Vdc	QP: Quarter-brick Peta HP: Half-brick Peta	N: Encased, Threaded Baseplate D: Encased, Non-threaded Baseplate F: Encased, Flanged Baseplate	S: S-Grade M: M-Grade

Example: MPFC-U-390-HP-N-M For valid part numbers, refer to the website or contact your local sales representative.

Model Number	Input Voltage	Output Voltage	Output Power
MPFC-U-390-HP	85-264 Vrms	390 Vdc	700 W
MPFC-115-270-HP	85-180 Vrms	270 Vdc	700 W
MPFC-U-390-QP	85-264 Vrms	390 Vdc	350 W
MPFC-115-270-QP	85-180 Vrms	270 Vdc	350 W

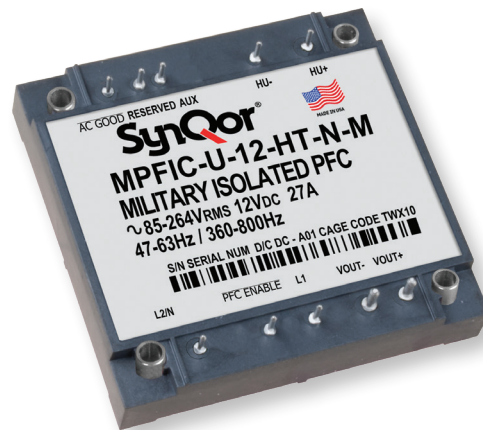

Mil-COTS Isolated Power Factor Correction Module

The MPFICQor Power Factor Correction module is a high power, high efficiency AC-DC converter. It operates from a universal AC input and generates an isolated output. Both regulated and semi-regulated (droop version) modules are available. Used in conjunction with a hold-up capacitor, and SynQor’s MCOTS AC line filter, the MPFICQor will draw a nearly perfect sinusoidal current (PF>0.99) from a single phase AC input. The module is supplied completely encased to provide protection from the harsh environments seen in many military and aerospace environments.

Operational Features

- Isolated output, 325 W, 600 W & 800 W
- Universal input frequency range: 47 - 63 Hz / 360 - 800 Hz
- Input voltage range: 85-264 Vrms
- ≥0.99 Power Factor
- High efficiency: 92% (230 Vrms)
- -55 °C to +100 °C Operating Temperature
- Internal inrush current control. Full-brick model has enhanced control that keeps inrush current to nearly zero
- Auxiliary bias supply
- Can be paralleled (droop version only)
- Compatible with SynQor’s MCOTS AC line filters
- Hold-up available on 600 W FG Model only

Protection/Control Features

- PFC Enable
- AC and DC Power Good outputs
- Input current limit and auto-recovery short circuit protection
- Auto-recovery input under / over-voltage protection
- Auto-recovery output over-voltage protection
- Auto-recovery thermal shutdown
- Battle Short - (Full-bricks Only)
- Asynchronous Serial data interface (Full-bricks Only)



Mil-COTS Isolated Power Factor Correction Module

Family	Input Voltage	Output Voltage	Package Size	Thermal Design	Screening Level	Option
MPFIC	U: 85-264 V	12: 12 V	HT: Half-brick Tera FG: Full-brick Giga FT: Full-brick Tera	N: Encased D: Encased with Non-threaded Baseplate F: Encased with Flanged Baseplate	S: S-Grade M: M-Grade	[]: Standard D: Droop H: Hold-up DH: Droop w/ Hold-up
		24: 24 V				
		28: 28 V				
		48: 48 V				
		55: 55 V				

Example: MPFIC-U-12-HT-N-M



MPFCQor™

3-Phase Power Factor Correction



Mil-COTS 3-Phase Power Factor Correction Module

The MPFCQor Power Factor Correction module is an essential building block of an AC-DC power supply. Used in conjunction with SynQor's MCOTS AC line filter and a limited amount of stabilizing capacitance, the 3-Phase MPFCQor will draw a nearly perfect sinusoidal current from each phase of a 3-Phase AC input. The module is supplied completely encased to provide protection from the harsh conditions seen in many military and extreme environments.

Operational Features

- Full-brick form factor industry standard
- 1.5 kW continuous (2.0 kW surge)
- Semi-regulated output: 270 Vdc
- Compatible with Military Standard 60 Hz, 400 Hz and variable frequency systems
- Meets military standards for harmonic content
- Minimal Inrush current
- Compatible with large external hold-up capacitors
- Additional Half-brick input filter available to meet full EMI
- 100 °C max baseplate temperature at full power
- -55 °C to +100 °C Operating Temperature
- Parallelable for higher power on a common input filter
- Compatible with SynQor's MCOTS Converters
- Enables systems with repetitive load transients to pass MIL-STD-461 CE101 with superior load current rejection

Protection/Control Features

- PFC Enable
- AC and DC Power Good outputs
- Clock synchronization output
- Input current limit and auto-recovery short circuit protection
- Auto-recovery input under / over-voltage protection
- Auto-recovery output over-voltage protection
- Auto-recovery thermal shutdown
- Parallel Option Available



Mil-COTS 3-Phase Power Factor Correction Module

Family	Vin Range	Input Phases	Vout	Package Size	Thermal Design	Screening Level
MPFC	115: 85-140 Vrms L-N	3PH: 3-Phase	270: 270 Vdc 270P: 270 Vdc, parallel option	FP: Full-brick Peta	N: Encased, Threaded Baseplate D: Encased, Non-Threaded Baseplate F: Encased, Flanged Baseplate	S: S-Grade M: M-Grade

Example: MPFC-115-3PH-270-FP-N-M For valid part numbers, refer to the website or contact your local sales representative.

Model Number	Input Voltage	Output Voltage	Output Power
MPFC-115-3PH-270-FP	3-Phase 85-140 Vrms L-N	270 Vdc	1500 W
MPFC-115-3PH-270P-FP	3-Phase 85-140 Vrms L-N	270 Vdc	N* 1500 W

MPFCQor™

High Voltage 3-Phase Power Factor Correction



Military Grade 3-Phase Power Factor Correction Module

The high voltage 3-Phase MPFCQor Power Factor Correction module is an essential building block of an AC-DC power supply. Used in conjunction with one of SynQor's matched 3-Phase AC line filters and a limited amount of stabilizing capacitance, this MPFCQor will draw well-balanced and low-distortion sinusoidal currents from each phase of a 3-Phase AC input. It is designed to comply with a wide range of military standards and is manufactured in the United States.

Operational Features

- Large-module form factor
- 5.0 kW continuous rating at 80 °C baseplate temperature
- Semi-regulated output: 400 Vdc
- Compatible with Military Standard 60 Hz, 400 Hz and variable frequency systems
- Meets military standards for harmonic content
- Drives pulsed output loads without passing transients back to the input (requires adequate capacitance; see pulsed loads section)
- Minimal inrush current
- Balanced phase currents
- High power factor (0.999 at 60 Hz / 5.0 kW)
- Minimal external output capacitance needed
- Supports full load current during startup ramp
- Additional input filters available to meet full EMI
- N * 5.0 kW power levels when paralleled

Protection/Control Features

- All control pins referenced to separate floating return
- Asynchronous serial data interface
- AC and DC Power Good outputs
- PFC Enable and Battle Short inputs
- 3.3 V always-on standby power output
- Clock synchronization output
- Output current limit and auto-recovery short circuit protection
- Auto-recovery input under / over-voltage protection
- Auto-recovery output over-voltage protection
- Auto-recovery thermal shutdown



Mil-COTS 3-Phase Power Factor Correction Module

Family	Vin Range	Input Phases	Vout	Package Size	Thermal Design	Screening Level
MPFC	440: 440 Vrms L-L	3PH: 3-Phase	400: 400 Vdc	LE: Large-module Exa	D: Encased, Non-Threaded Baseplate	S: S-Grade M: M-Grade

Example: MPFC-440-3PH-400-LE-D-M For valid part numbers, refer to the website or contact your local sales representative.

MPFICQor™

3-Phase Isolated Power Factor Correction



Mil-COTS 3-Phase Isolated Power Factor Correction Module

The MPFICQor Military Isolated PFC Module is a high power, high efficiency AC-DC converter. It operates from a 115 Vrms AC input and generates an isolated DC output. Both regulated output and droop output modules are available. Used in conjunction with a holdup capacitor, and SynQor's MCOTS AC line filter, the MPFICQor will draw a nearly perfect sinusoidal current (PF>0.99) from a 3-Phase AC input. The module is supplied completely encased to provide protection from the harsh environments seen in many military and aerospace environments.

Operational Features

- Compatible with Military Standard 60 Hz, 400 Hz and variable frequency systems
- Harmonic content meets military standards
- Superior load current rejection, enabling systems with repetitive load CE101 requirement by offering superior load current rejection
- Minimal inrush current
- Balanced phase currents
- High power factor (0.99 at 400 Hz / 750 W)
- Minimal external output capacitance requirement
- Full load current during startup
- Ability to meet full EMI with available additional EMI filters
- N * 750 W power levels when paralleled

Protection/Control Features

- All control pins referenced to separate floating return
- Asynchronous serial data interface
- AC and DC Power Good outputs
- PFC Enable and Battle Short inputs
- 3.3 V always-on standby power output
- Clock synchronization output



Mil-COTS Isolated Power Factor Correction Module

Family	Input Voltage	Output Voltage	Regulation	Package Size	Thermal Design	Screening Level
MPFIC	115-3PH: 3-Phase 115 Vrms L-N	12: 12 V 24: 24 V 28: 28 V 48: 48 V 54: 54 V	R: Regulated output D: Droop Sharing	FT: Full-brick Tera	N: Encased D: Encased with Non-threaded Baseplate F: Encased with Flanged Baseplate	S: S-Grade M: M-Grade

Example: MPFIC-115-3PH-12R-FT-N-S

MilCOTS™

3-Phase AC Filters



Mil-COTS 3-Phase AC Line Filter Modules

SynQor provides AC Line filters for the MIL-COTS series of PFC modules and DC-DC converters. SynQor’s high-performance filters are designed to comply with military EMI standards. These filters have high differential-mode attenuation and low series resistance.

Filter Features

- 1-2 kW @ 115 V
- 7.6 kW @ 440 V_{RMS (L-L)} (HV 3-Phase)
- 3.0-10.0 Arms
- Very low series resistance
- Internally damped
- High voltage isolation between baseplate and input/output
- -55 °C to +100 °C Operating Temperature
- Low power dissipation
- Complies with industry EMI standards when used with SynQor MPFC and MCOTS DC-DC converter modules
- Quarter-brick filter with Differential-Mode filtering only for use with Parallelable 3-Phase PFC model

Mil-COTS 3-Phase AC Line Filter

Family	Vin Range (L-N)	Phase	Input Frequency	Package Size	Thermal Design	Screening Level
MACF	115: 85-140 Vrms 440: 360-528 Vrms	3PH: 3-Phase	UNV: Universal UNVD: Universal (Differential-Mode only)	QG: Quarter-brick Giga QT: Quarter-brick Tera HT: Half-brick Tera MP: Medium-Module Peta	N: Encased, Threaded Baseplate D: Encased, Non-Threaded Baseplate F: Encased, Flanged Baseplate	S: S-Grade M: M-Grade

Example: MACF-115-3PH-UNV-HT-N-M For valid part numbers, refer to the website or contact your local sales representative.

Model Number	Input Phase	Input Frequency	Input Voltage	Output Current	Output Power
MACF-115-3PH-UNV-QG	3-Phase	45-800 Hz	85-140 Vrms (L-N)	3 ARMS	1 kW @ 115 VRMS (L-N)
MACF-115-3PH-UNVD-QT	3-Phase	45-800 Hz	85-140 Vrms (L-N)	6 ARMS	2 kW @ 115 VRMS (L-N)
MACF-115-3PH-UNV-HT	3-Phase	45-800 Hz	85-140 Vrms (L-N)	8 ARMS	2 kW @ 115 VRMS (L-N)
MACF-440-3PH-UNV-MP	3-Phase	45-800 Hz	320-528 Vrms (L-L)	10 ARMS	7.6 kW @ 440 VRMS (L-L)

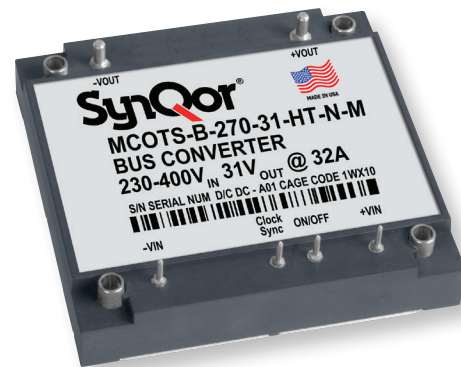

Mil-COTS Rugged, High Efficiency Next Generation DC-DC Bus Converters

These Military bus converters are the next-generation, board-mountable, isolated, fixed switching frequency DC-DC converters that use synchronous rectification to achieve extremely high conversion efficiency. MCOTS Bus converters are ideal for creating the mid-bus voltage required to drive point-of-load (non-isolated) converters in Intermediate Bus Architectures.

Operational Features

- High efficiency, up to 97% at full rated load current
- Delivers up to 65 A @ full power with minimal derating
- Operating input voltage range: 230-400 V, 440-700 V, 700-900 V, and 800-1000 V
- Fixed frequency switching provides predictable EMI
- No minimum load requirement
- Industry standard half-brick pin-out configuration
- -55 °C to +100 °C Operating Temperature

Protection/Control Features

- Input under-voltage and over voltage lockout protects against abnormal input voltages
- Output current limit and short circuit protection (auto recovery)
- Thermal shutdown
- On/Off control referenced to input side
- Inherent current share (by droop method) for high current and parallel applications
- Clock synchronization (primary reference)

Mil-COTS Isolated DC-DC Bus Converters

Family	Product	Vin Range	Vout	Package Size	Thermal Design	Screening Level
MCOTS	B: Bus Converter	270: 230-400 V 385: 230-400 V 600: 440-700 V 800: 700-900 V 900: 800-1000 V	28: 28 V 31: 31 V 48: 48 V 270: 270 V	HT: Half-brick Tera FT: Full-brick Tera	N: Encased, Threaded Baseplate D: Encased, Non-Threaded Baseplate F: Encased, Flanged Baseplate	S: S-Grade M: M-Grade

Example: MCOTS-B-600-31-HT-N-M For valid part numbers, refer to the website or contact your local sales representative.

Model Number	Package Size	Input Voltage	Input Transient	Output Voltage	Output Current	Max Output Power	Efficiency
MCOTS-B-270-31-HT	Half-Brick	230-400 V	155-450 V	29.7 V	32.5 A	1000 W	95%
MCOTS-B-385-270-HT	Half-Brick	230-400 V	155-450 V	270 V	3.7 A	999 W	95%
MCOTS-B-600-31-HT	Half-Brick	440-700 V	400-750 V	30.3 V	32.5 A	1000 W	95%
MCOTS-B-270-31-FT	Full-Brick	230-400 V	155-450 V	31 V	65 A	2015 W	96%
MCOTS-B-800-48-FT	Full-Brick	700-900 V	700-950 V	50 V	63 A	3000 W	97%
MCOTS-B-900-28-FT	Full-Brick	800-1000 V	750-1050 V	28 V	107 A	3000 W	97%
MCOTS-B-900-48-FT	Full-Brick	800-1000 V	750-1050 V	50 V	60 A	3000 W	97%

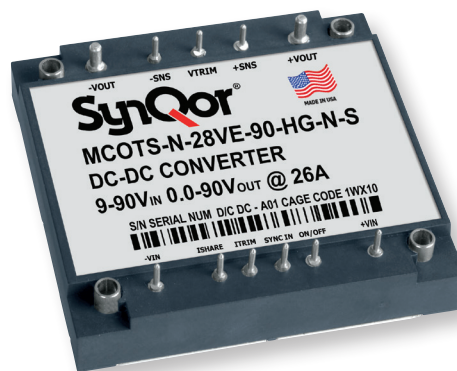

Mil-COTS High Voltage, Non-Isolated DC-DC Converters

The high input voltage non-isolated DC-DC converters offer unique solutions for converting high-powered, variable voltages to a wide range of output voltages. The converter is a non-isolated buck-boost regulator, which employs synchronous rectification to achieve extremely high conversion efficiency. These products are suitable for use in Intermediate Bus Architectures, or to provide a regulated output voltage from a variable voltage source such as a battery. They can be configured to ‘buck’ the input voltage down or ‘boost’ the input voltage up with a single external setpoint resistor.

Operational Features

- Ultra-high efficiency up to 97%
- Wide input voltage ranges: 9-60 V (28 V); 9-90 V (28 VE)
- Buck/Boost Mode available
- Maximum input/output currents up to 40 A
- Suitable for use in Intermediate Bus Architectures
- On-board input and output filtering
- No minimum load requirement
- -55 °C to +100 °C Operating Temperature
- Remote sense and wide output voltage trim (Half-brick only)

Protection/Control Features

- Input under-voltage lockout (UVLO)
- Output current limit (OCP) and short circuit protection
- Output over-voltage protection (OVP)
- Thermal shutdown (OTP)
- Output voltage trim

Mil-COTS Non-Isolated DC-DC Converters

Family	Product	Vin Range	Vout	Package Size	Thermal Design	Screening Level
MCOTS	N: Non-isolated Converter	28V: 9-60 V 28VE: 9-90 V	60: 0-60 V 90: 0-90 V	HG: Half-brick Giga QT: Quarter-brick Tera EP: Eighth-brick Peta	N: Encased, Threaded Baseplate D: Encased, Non-threaded Baseplate F: Encased, Flanged Baseplate	S: S-Grade M: M-Grade

Example: MCOTS-N-28VE-90-HG-N-M For valid part numbers, refer to the website or contact your local sales representative.

Model Number	Brick Size	Input Voltage	Output Voltage	Current	Max Output Power	High Efficiency
MCOTS-N-28V-60-HG	Half-brick	9-60 V	0-60 V	40 A	2000 W	96% Efficiency
MCOTS-N-28V-60-QT	Quarter-brick	9-60 V	0-60 V	25 A	1500 W	96% Efficiency
MCOTS-N-28V-60-EP	Eighth-brick	9-60 V	0-60 V	15 A	900 W	95% Efficiency
MCOTS-N-28VE-90-HG	Half-brick	9-90 V	0-90 V	26 A	2000 W	96% Efficiency
MCOTS-N-28VE-90-QT	Quarter-brick	9-90 V	0-90 V	18 A	1500 W	97% Efficiency
MCOTS-N-28VE-90-EP	Eighth-brick	9-90 V	0-90 V	10 A	900 W	96% Efficiency

Battery Charging

Key feature of Trimmable Current Limit

- Provides the power conversion platform for battery charging
- Output current limit is externally controlled for constant-current charging
- Current can be set with an external resistor or an active circuit
- Current analog signal provided for instrumentation and control functions
- Ideal diode output stage with zero back-drive currents prevents discharge of battery when not charging
- Output voltage set-point is independently controlled through trim pin
- Unit will smoothly transition between current and voltage modes as charging cycle needs change



QuadQor™

Non-Isolated Converters



Mil-COTS Non-Isolated DC-DC Converters

The MCOTS QUAD Output non-isolated DC-DC converter employs synchronous rectification to achieve extremely high conversion efficiency in a quarter brick package. The module generates three positive output voltages, and one negative output voltage. The MCOTS QUAD Output Brick converter can be used in traditional DPA (distributed power architecture) systems that require a more rugged design. All four outputs have a wide output trim range, creating a high degree of flexibility for the user.

Operational Features

- High efficiency, up to 93% at full rated load current
- Delivers up to 30 A on each positive output and 1 A on the negative output
- Input Voltage Range: 6-15 V
- Output Voltage Range:
Positive Outputs: 00 to 5 V
Negative Output: -3.0 V to -13.5 V
- -55 °C to +100 °C Operating Temperature

Protection/Control Features

- Over-current shutdown (all outputs)
- Thermal shutdown (all outputs)
- Over-voltage shutdown (positive outputs only)
- Input under-voltage lockout (positive outputs only)
- On/Off control for each output
- Output voltage trim for each output permits custom voltages
- Remote Sense (positive outputs only)

Mil-COTS Quad Output Non-Isolated Converter

Family	Product	Vin Range	Output Voltage	Package Size	Thermal Design	Screening Level
MCOTS	N: Non-isolated Converter	12: 6-15 V	Q3P1N: Quad Output 3 Positive, 1 Negative	QT: Quarter-brick Tera	N: Encased, Threaded Baseplate F: Encased, Flanged Baseplate	S: S-Grade M: M-Grade

Example: MCOTS-N-12-Q3P1N-QT-N-M For valid part numbers, refer to the website or contact your local sales representative.

Model Number	Package Size	Input Voltage	Output Voltage
MCOTS-N-12-Q3P1N-QT	Quarter-brick	6-15 V	30 A Positive Outputs, 1 A Negative Output

See “Encased Package Configurations” on page 95 for package outlines.

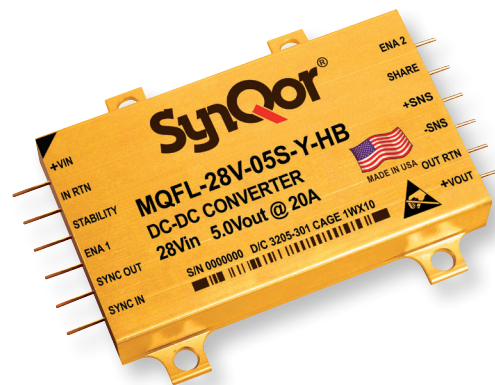

High-Reliability, Field Proven DC-DC Converters for Military/Aerospace Applications

The MilQor® series of high-reliability DC-DC converters brings SynQor's field proven high-efficiency synchronous rectifier technology to the Military/Aerospace industry. SynQor's innovative **QorSeal**® packaging approach ensures survivability in the most hostile environments. Compatible with the industry standard format, these converters operate at a fixed frequency, have no opto-isolators, and follow conservative component derating guidelines.

Hi-Rel Product Features

- Fixed switching frequency
- No opto-isolators
- Parallel operation with current share on MQFL
- Remote sense
- Clock synchronization
- Primary referenced enable
- Secondary referenced enable on MQFL
- Continuous short circuit and overload protection with auto-restart feature
- Input under-voltage and over-voltage shutdown
- Output voltage trim range (MQHL, MQHR and MQBL) +10% to -10%
- -55 °C to +125 °C Operating Temperature

Design Process

Hi-Rel series converters are:

- Designed for reliability per:
 - NAVSO P-3641 A guidelines
- Designed with components derated per:
 - MIL-HDBK-1547 A
 - NAVSO P-3641 A

Qualification Process

Hi-Rel series converters are qualified to:

- MIL-STD-810
 - consistent with RTCA/DO-160
- SynQor's First Article Qualification
 - consistent with MIL-STD-883
- SynQor's Long-Term Storage Survivability Qual.
- SynQor's on-going life test
- SynQor's element evaluation for HB and ES Grade

Specification Compliance

Hi-Rel series converters (with Hi-Rel filter) are designed to meet:

- MIL-HDBK-704
- RTCA/DO-160 Section 16, 17, 18
- MIL-STD-1275
- DEF-STAN 61-5 (Part 6)/(5, 6)
- MIL-STD-461
- RTCA/DO-160 Section 22

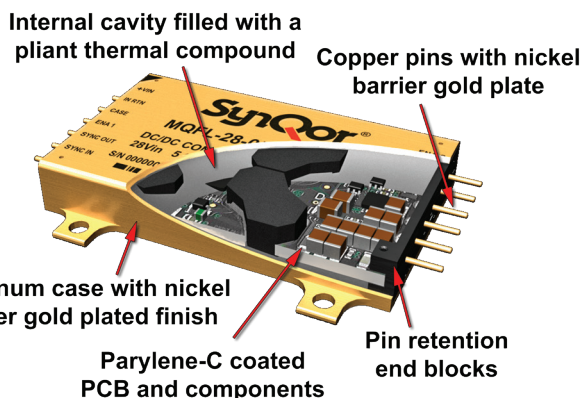

Our unique **QorSeal**® packaging approach provides a conduction-cooled mechanical assembly around an SMT constructed power circuit that is low-profile, light-weight, and shielded. This process provides three levels of Tin Whisker mitigation.

Military Hi-Rel Isolated DC-DC Converters



91% Efficiency

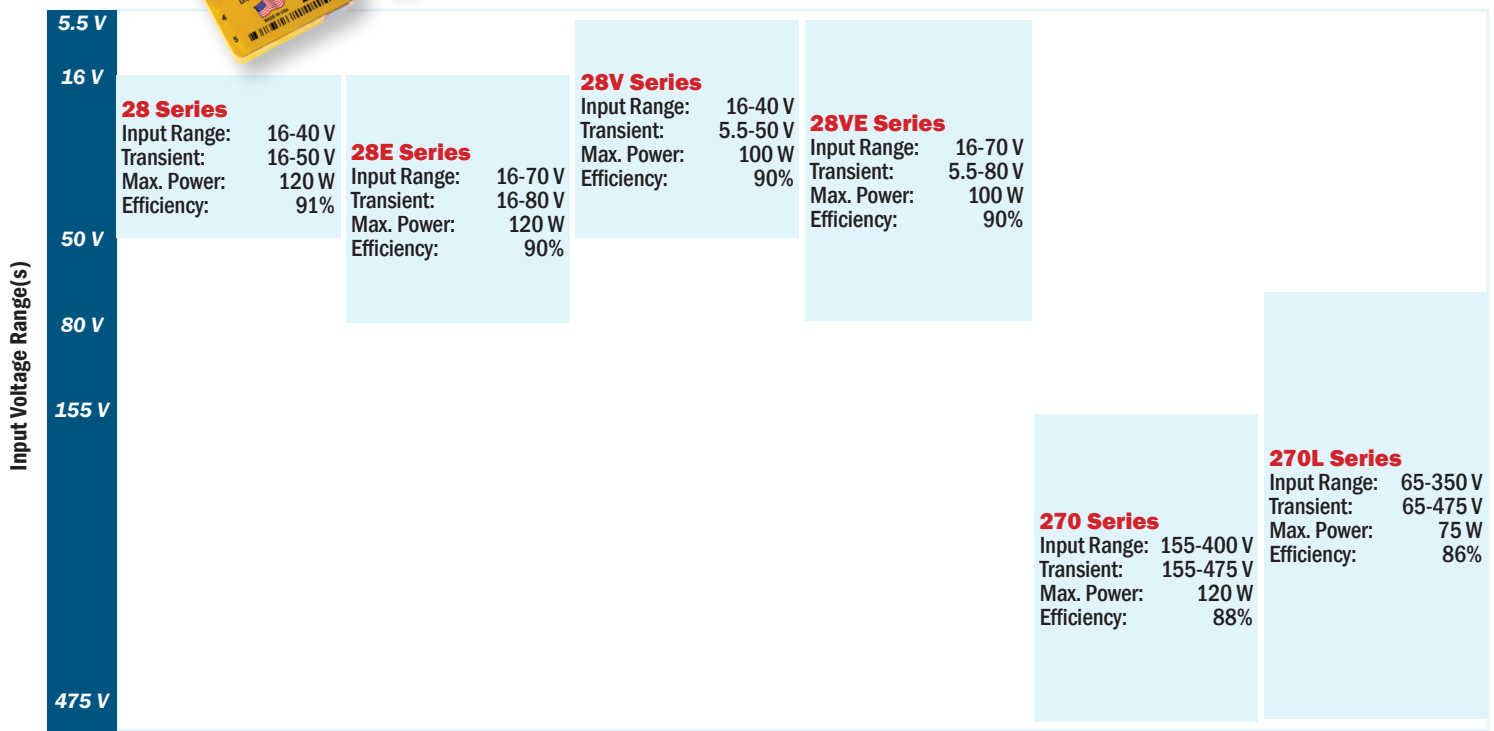
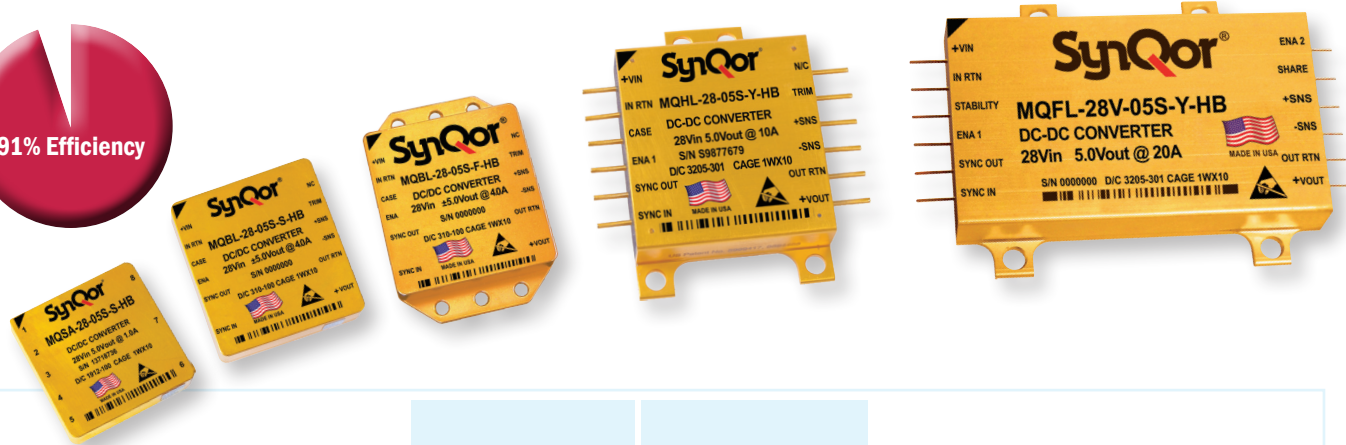

Hi-Rel DC-DC Converters

Family	System Input Voltage (with transients)	Output Voltage(s)		Package Size/ Pin Configuration	Screening Grade
		Single Output	Dual Output		
MQFL MQHL MQHR MQBL MQSA	28: 16-40 V (16-50 V) 28E: 16-70 V (16-80 V) 28V: 16-40 V (5.5-50 V) 28VE: 16-70 V (5.5-80 V) 270: 155-400 V (155-475 V) 270L: 65-350 V (65-475 V)	1R5S: 1.5 V 1R8S: 1.8 V 2R5S: 2.5 V 3R3S: 3.3 V 05S: 5.0 V 06S: 6.0 V 6R5S: 6.5 V 7R5S: 7.5 V 08S: 8.0 V 09S: 9.0 V 12S: 12 V 15S: 15 V 28S: 28 V	05D: ±5.0 V 6R5D: ±6.5 V 12D: ±12 V 15D: ±15 V	U X Y W Z (FL, HL, HR) S F (BL) S (SA)	C ES HB

Family	System Input Voltage (with transients)	Nominal Output Voltage(s)	Package Size/ Pin Configuration	Screening Grade
MQBQ	28: 18-40 V (16-50 V) 270: 230-400 V (155-450 V)	28B: (1:1) 28B: (9:1)	U X Y W Z	C ES HB

Example: MQHL-28-05S-Y-HB For valid part numbers, refer to the website or contact your local sales representative.

Single Output

Dual Output†

Full Size (MQFL)	1.5 V 1R5S	1.8 V 1R8S	2.5 V 2R5S	3.3 V 3R3S	5 V 05S	6 V 06S	6.5 V 6R5S	7.2 V 7R2S	7.5 V 7R5S	7.7 V 7R7S	8 V 08S	9 V 09S	12 V 12S	15 V 15S	28 V 28S	±5 V 05D	±6.5 V 6R5D	±12 V 12D	±15 V 15D
MQFL-28 (120 W) 16-40 Vin Cont. 16-50 Vin 1s Trans. Absolute Max Vin = 60 V	40 A 60 W	40 A 72 W	40 A 100 W	30 A 99 W	24 A 120 W	20 A 120 W	18 A 117 W	16 A 115 W	16 A 120 W	16 A 120 W	15 A 120 W	13 A 117 W	10 A 120 W	8 A 120 W	4 A 112 W	24 A 120 W Total	18 A 117 W Total	10 A 120 W Total	8 A 120 W Total

Single Output

Dual Output†

Full Size (MQFL)	1.5 V 1R5S	1.8 V 1R8S	2.5 V 2R5S	3.3 V 3R3S	5 V 05S	6 V 06S	7.5 V 7R5S	9 V 09S	12 V 12S	15 V 15S	28 V 28S	±5 V 05D	±12 V 12D	±15 V 15D
MQFL-28E (120 W) 16-70 Vin Cont. 16-80 Vin 1s Trans. Absolute Max Vin = 100 V	40 A 60 W	40 A 72 W	40 A 100 W	30 A 99 W	24 A 120 W	20 A 120 W	16 A 120 W	13 A 117 W	10 A 120 W	8 A 120 W	4 A 112 W	24 A 120 W Total	10 A 120 W Total	8 A 120 W Total
MQFL-28V (100 W) 16-40 Vin Cont. 5.5-50 Vin 1s Trans. Absolute Max Vin = 60 V				30 A 99 W	20 A 100 W			11 A 99 W	8 A 96 W		3.3 A 92 W			
MQFL-28VE (100 W) 16-70 Vin Cont. 5.5-80 Vin 1s Trans. Absolute Max Vin = 100 V				30 A 99 W	20 A 100 W			11 A 99 W	8 A 96 W		3.3 A 92 W			
MQFL-270 (120 W) 155-400 Vin Cont. 155-475 Vin 1s Trans. Absolute Max Vin = 550 V	40 A 60 W	40 A 72 W	40 A 100 W	30 A 99 W	24 A 120 W	20 A 120 W	16 A 120 W	13 A 117 W	10 A 120 W	8 A 120 W	4 A 112 W	24 A 120 W Total	10 A 120 W Total	8 A 120 W Total
MQFL-270L (75 W) 65-350 Vin Cont. 65-475 Vin 1s Trans. Absolute Max Vin = 550 V					15 A 75 W					5 A 75 W	2.7 A 75 W			

Single Output

Dual Output†

Half Size (MQHL)	1.5 V 1R5S	1.8 V 1R8S	2.5 V 2R5S	3.3 V 3R3S	5 V 05S	6 V 06S	7.5 V 7R5S	9 V 09S	12 V 12S	15 V 15S	28 V 28S	±5 V 05D	±12 V 12D	±15 V 15D
MQHL-28 (50 W) 16-40 Vin Cont. 16-50 Vin 1s Trans. Absolute Max Vin = 60 V	20 A 30 W	20 A 36 W	20 A 50 W	15 A 50 W	10 A 50 W	8 A 48 W	6.6 A 50 W	5.5 A 50 W	4 A 48 W	3.3 A 50 W	1.8 A 50 W	10 A 50 W Total	4 A 48 W Total	3.3 A 50 W Total
MQHL-28E (50 W) 16-70 Vin Cont. 16-80 Vin 1s Trans. Absolute Max Vin = 100 V	20 A 30 W	20 A 36 W	20 A 50 W	15 A 50 W	10 A 50 W	8 A 48 W	6.6 A 50 W	5.5 A 50 W	4 A 48 W	3.3 A 50 W	1.8 A 50 W	10 A 50 W Total	4 A 48 W Total	3.3 A 50 W Total
Half Size (MQHR)	1.5 V 1R5S	1.8 V 1R8S	2.5 V 2R5S	3.3 V 3R3S	5 V 05S	6 V 06S	7.5 V 7R5S	9 V 09S	12 V 12S	15 V 15S	28 V 28S	±5 V 05D	±12 V 12D	±15 V 15D
MQHR-28 (25 W) 16-40 Vin Cont. 16-50 Vin 1s Trans. Absolute Max Vin = 60 V	10 A 15 W	10 A 18 W	10 A 25 W	7.5 A 25 W	5 A 25 W	4 A 24 W	3.3 A 25 W	2.75 A 25 W	2 A 24 W	1.65 A 25 W	0.9 A 25 W	5 A 25 W Total	2 A 24 W Total	1.65 A 25 W Total
MQHR-28E (25 W) 16-70 Vin Cont. 16-80 Vin 1s Trans. Absolute Max Vin = 100 V	10 A 15 W	10 A 18 W	10 A 25 W	7.5 A 25 W	5 A 25 W	4 A 24 W	3.3 A 25 W	2.75 A 25 W	2 A 24 W	1.65 A 25 W	0.9 A 25 W	5 A 25 W Total	2 A 24 W Total	1.65 A 25 W Total

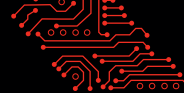

Single Output

Dual Output†

Bottom Pin (MQBL)	2.5 V 2R5S	3.3 V 3R3S	5 V 05S	6 V 06S	7.5 V 7R5S	9 V 09S	12 V 12S	15 V 15S	28 V 28S	±5 V 05D	±12 V 12D	±15 V 15D
MQBL-28 (20 W) 16-40 Vin Cont. 16-50 Vin 1s Trans. Absolute Max Vin = 60 V	8 A 20 W	6 A 19.8 W	4 A 20 W	3.3 A 19.8 W	2.6 A 19.5 W	2.2 A 19.8 W	1.6 A 19.2 W	1.3 A 19.5 W	0.72 A 20.2 W	4 A 20 W Total	1.6 A 19.2 W Total	1.3 A 19.5 W Total
MQBL-28E (20 W) 16-70 Vin Cont. 16-80 Vin 1s Trans. Absolute Max Vin = 100 V	8 A 20 W	6 A 19.8 W	4 A 20 W	3.3 A 19.8 W	2.6 A 19.5 W	2.2 A 19.8 W	1.6 A 19.2 W	1.3 A 19.5 W	0.72 A 20.2 W	4 A 20 W Total	1.6 A 19.2 W Total	1.3 A 19.5 W Total

Single Output

Bottom Pin (MQSA)	5 V 05S	12 V 12S	15 V 15S	28 V 28S
MQSA-28 (5 W) 16-40 Vin Cont. 16-50 Vin 1s Trans. Absolute Max Vin = 60 V	1 A 5 W	0.42 A 5 W	0.33 A 5 W	0.18 A 5 W
MQSA-28E (5 W) 16-70 Vin Cont. 16-80 Vin 1s Trans. Absolute Max Vin = 100 V	1 A 5 W	0.42 A 5 W	0.33 A 5 W	0.18 A 5 W

† 80% of total output available on any one output.

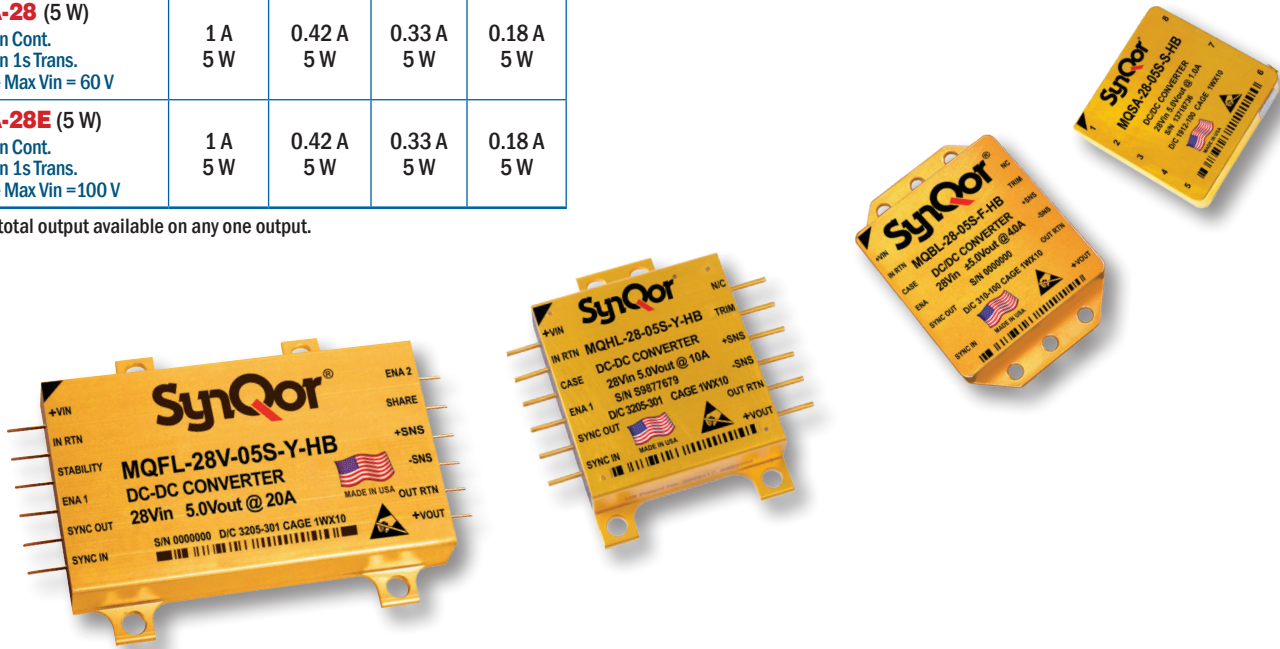

Hi-Rel™

Bus Converters

Bus Converters (MQBQ)	$V_{out} = \sim V_{in}/1$ 28B
MQBQ-28 18-40 Vin Cont. 16-50 Vin 1s Trans. Absolute Max Vin = 60 V	14 A 400 W
Bus Converters (MQBQ)	$V_{out} = \sim V_{in}/9$ 28B
MQBQ-270 230-400 Vin Cont. 155-450 Vin 1s Trans. Absolute Max Vin = 550 V	14 A 400 W

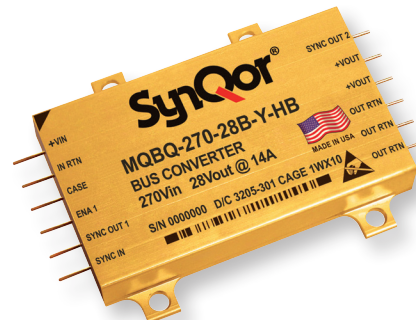

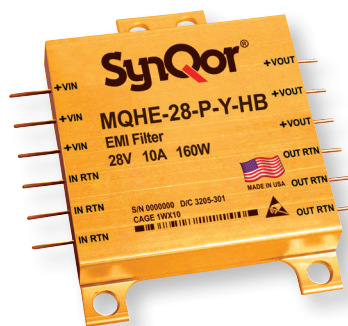

High-Reliability, Field Proven Filters for Military/Aerospace Applications

The MilQor® series of high-reliability EMI Filters bring SynQor’s field proven technology to the Military/Aerospace industry. SynQor’s innovative QorSeal® packaging approach ensures survivability in the most hostile environments. Compatible with the industry standard format, these filters follow conservative component tracking guidelines.

Model Number	Input Voltage		Output Current	Isolation Voltage (to case)	Maximum DC Resistance @ 125 °C	Differential-Mode Attenuation (@ 500 kHz)	Common-Mode Attenuation (@ 500 kHz)
	Continuous	Surge ³ (≤100ms)					
Full Size							
MQME-28-P	± 40 V	±100 V	20 A	500 V	35 mΩ	>80 dB	>60 dB
MQME-28-T¹	±40 V	+100, -50 V	20 A	500 V	60 mΩ	>80 dB	>60 dB
MQME-28E-P	±70 V	±100 V	20 A	500 V	35 mΩ	>80 dB	>60 dB
MQME-28E-T¹	+70, -40 V	+100V, -50V	20 A	500 V	60 mΩ	>80 dB	>60 dB
MQME-28E-T6¹	+70, -40 V	+100V, -50V	20 A	500 V	60 mΩ	>80 dB	>60 dB
MQME-270-P	±400 V	±1000 V	2.0 A	500 V	1.6Ω	>80 dB	>60 dB
MQME-270-R²	±400 V	±1000 V	2.0 A	500 V	1.6Ω	>80 dB	>60 dB
MQME-270L-P⁴	±400 V	±500 V	3.0 A	500 V	0.86Ω	>80 dB	>60 dB
MQME-270L-R^{2,4}	±400 V	±500 V	3.0 A	500 V	0.86Ω	>80 dB	>60 dB
Half Size							
MQHE-28-P	±40 V	±100 V	10 A	500 V	60 mΩ	>80 dB	>60 dB
MQHE-28E-P	±70 V	±100 V	10 A	500 V	60 mΩ	>80 dB	>60 dB
MQHE-270-P	±400 V	±500 V	1.0 A	500 V	450 mΩ	>50 dB	>60 dB

Note 1 - T and T6 filters feature enable pass-through, transient suppression, soft-start and reverse polarity protection circuitry in addition to passive filter components.

Note 2 - R filters feature reverse polarity protection circuitry in addition to passive filter components.

Note 3 - While the passive filters can withstand these long-duration surge voltages, the surge voltage will be passed to the filter’s load. Care should therefore be taken to make sure that the load will also be able to withstand any applied surges. The transient suppression filters block surges of either polarity, as specified in their data sheets

Note 4 - Designed specifically to be matched with MQFL-270L DC-DC converters.

See “MilQor Hi-Rel Package Configurations” on page 97 for package outlines.



Hi-Rel™ SCREENING



SCREENING	Consistent with MIL-STD-883	C-Grade (0 °C to +70 °C)	ES-Grade (-45 °C to +100 °C)	HB-Grade (-55 °C to +125 °C)
Element Evaluation		No	Yes	Yes
Internal Visual	<i>Per IPC-A-610 Class III</i>	Yes	Yes	Yes
Temperature Cycle	<i>Method 1010</i>	No	<i>Condition B (-55 °C to +125 °C)</i>	<i>Condition C (-65 °C to +150 °C)</i>
Constant Acc.	<i>Method 2001 (Y1 direction)</i>	No	500 g	<i>Condition A (5000 g)</i>
Burn-In	<i>Method 1015</i>	24hrs @ +125 °C	96hrs @ +125 °C	160hrs @ +125 °C
Final Electrical Test	<i>Method 5005 (Group A)</i>	+25 °C	-45 °C, +25 °C, +100 °C	-55 °C, +25 °C, +125 °C
External Visual	<i>Method 2009</i>	Yes	Yes	Yes
Construction			QorSeal®	QorSeal®

UPS **MILITARY FIELD-GRADE** Uninterruptible Power Supply

Sealed

Shock-Proof

Weather-Proof

Rugged Construction



Military Field-Grade Uninterruptible Power Supply (UPS-1500)

SynQor's Military Field-Grade Uninterruptible Power Supply units are designed for the extreme environmental and demanding electrical conditions of Military/Aerospace applications. SynQor's UPS incorporates field proven high efficiency designs and rugged packaging technologies. This UPS will accept a wide range of input voltage and frequency values while delivering a well-conditioned AC output to the load. The use of lithium ion batteries permits the lowest profile and lowest weight solution in its power class. It is designed to comply with a wide range of military standards. Options include two DC outputs, a DC input rated for military 28 VDC sources, and an electronic breaker on the AC output to permit fault-tolerant parallel operation for higher power and/or N+M redundant systems.

UPS Product Features

- Sealed, weather-proof, shock-proof construction
- Military Tough, Die-Cast Aluminum Chassis
- 1250 W-1500 VA; 2500 W-3000 VA output power
- UPS-1500-S-1U >10 minute run-time at full power
- Full power operation -20 °C to +55 °C
- Shallow Rack full power operation -20 °C to +50 °C
- Storage temperature: -40 °C to +65 °C
- True on-line double conversion
- Hot swappable internal battery pack (lithium ion)
- Universal AC input: 80-265 VAC; 47-65 Hz
- Dual input: AC and optional DC
- Cold-start with no AC or DC input connections
- Power factor correction at AC input
- Pure sinusoidal AC output voltage
- Handles 0.0 - 1.0 power factor loads and non-linear loads
- User I/O, Ethernet and Configuration signal ports
- Up to 3 units can be combined for higher power, voltage or a 3-Phase AC output
- Up to 32 units can be combined to form a higher power fault-tolerant, glitch-free system, perhaps with N+M redundancy, by ordering with the "AC Output Electronic Breaker" option and the appropriate configuration cable

Specification Compliance

UPS units are designed to meet:

- MIL-STD-704F - Aircraft Electrical Power Characteristics
- MIL-STD-1399-300B - Interface Std for Shipboard Systems
- MIL-STD-1275D - Vehicle Electrical Power Characteristics
- MIL-STD-461F - Electromagnetic Interference
- MIL-STD-810G - Environmental Engineering Considerations

Options

- DC input (28 Vnom) for dual source
- UPS-1500-M-1U/UPS-1500-M-2S >16 minutes of run-time and -40°C operation
- UPS-1500-H-1U/UPS-1500-H-2S >13.5 minutes of run-time
- Wide-range AC input frequency: 47 Hz to 800 Hz
- 3-Phase AC input: 85-140 Vrms_{L-N}
- 3-Phase AC input: 360-528 Vrms_{L-L}
- 115 Vrms or 230 Vrms AC output
- 50 Hz, 60 Hz, or 400 Hz output
- DC1: Auxiliary isolated DC output (up to 500 W)
- DC2: High power DC output parallelable for higher power (UPS-1500 up to 1250 W; UPS-3000 up to 2500 W)
- Shipboard version with floating neutral wire
- N+1 Redundancy



UPS-1500-[S,H,M]-1U
(17.00" x 21.60" x 1.73")

Military Field-Grade Uninterruptible Power Supply (UPS)

AC & DC Output Base Model Number	Power	Battery Run-Time@Full Power (80% Power)	Height (W x D x H)	Weight
UPS-1500-S-1U (1 BAT-0200-S Battery Pack)	1250 W 1500 VA	>10 min. (>13 min.)	1U (17.00" x 21.60" x 1.73")	32 lbs.
UPS-1500-H-1U (1 BAT-0400-H Battery Pack)	1250 W 1500 VA	>13.5 min. (>18 min.)	1U (17.00" x 21.60" x 1.73")	33.8 lbs.
UPS-1500-M-1U (1 BAT-0400-M Battery Pack)	1250 W 1500 VA	>16 min. (>22 min.)	1U (17.00" x 21.60" x 1.73")	33.8 lbs.
UPS-1500-S-2S (1 BAT-0200-S Battery Pack)	1250 W 1500 VA	>10 min. (>13 min.)	2U (17.00" x 13.80" x 3.40")	33 lbs.
UPS-1500-H-2S (1 BAT-0400-H Battery Pack)	1250 W 1500 VA	>13.5 min. (>18 min.)	2U (17.00" x 13.80" x 3.40")	34.8 lbs.
UPS-1500-M-2S (1 BAT-0400-M Battery Pack)	1250 W 1500 VA	>16 min. (>22 min.)	2U (17.00" x 13.80" x 3.40")	34.8 lbs.
UPS-3000-S-2U (2 BAT-0200-S Battery Packs)	2500 W 3000 VA	>10 min. (>13 min.)	2U (17.00" x 22.22" x 3.40")	65 lbs.
UPS-3000-H-2U (2 BAT-0400-H Battery Packs)	2500 W 3000 VA	>13.5 min. (>18 min.)	2U (17.00" x 22.22" x 3.40")	68.6 lbs.
UPS-3000-M-2U (2 BAT-0400-M Battery Packs)	2500 W 3000 VA	>16 min. (>22 min.)	2U (17.00" x 22.22" x 3.40")	68.6 lbs.

3-Phase AC & DC Output Base Model Number	Power	Battery Run-Time@Full Power (80% Power)	Height (W x D x H)	Weight
UPS-1500-S-1U-T (1 BAT-0200-S Battery Pack)	1250 W 1500 VA	>10 min. (>13 min.)	1U (17.00" x 22.53" x 1.73")	32 lbs.
UPS-1500-H-1U-T (1 BAT-0400-H Battery Pack)	1250 W 1500 VA	>13.5 min. (>18 min.)	1U (17.00" x 22.53" x 1.73")	33.8 lbs.
UPS-1500-M-1U-T (1 BAT-0400-M Battery Pack)	1250 W 1500 VA	>16 min. (>22 min.)	1U (17.00" x 22.53" x 1.73")	33.8 lbs.

3-Phase 440 (L-L) AC & DC Output Base Model Number	Power	Battery Run-Time@Full Power (80% Power)	Height (W x D x H)	Weight
UPS-1500-S-1U-4 (1 BAT-0200-S Battery Pack)	1250 W 1500 VA	>10 min. (>13 min.)	1U (17.00" x 22.64" x 1.73")	33 lbs.
UPS-1500-H-1U-4 (1 BAT-0400-H Battery Pack)	1250 W 1500 VA	>13.5 min. (>18 min.)	1U (17.00" x 22.64" x 1.73")	34.8 lbs.
UPS-1500-M-1U-4 (1 BAT-0400-M Battery Pack)	1250 W 1500 VA	>16 min. (>22 min.)	1U (17.00" x 22.64" x 1.73")	34.8 lbs.

AC & DC Output Base Models	Options						
	AC Input	AC Output Voltage	AC Output Neutral Wire	AC Output Set Point Freq	DC Input / DC2 Output	DC1 Output	Additional Options
UPS-1500-S-1U-					S	00	
UPS-1500-H-1U-					D	12	
UPS-1500-M-1U-					M	15	
UPS-1500-S-2S-	L	1	G	5	M	15	-E 00
UPS-1500-H-2S-	W	2	F	6	P	24	CE
UPS-1500-M-2S-	T		R	4	R	28	
UPS-3000-S-2U-	4				V	40	
UPS-3000-H-2U-					W	50	
UPS-3000-M-2U-							

Not all combinations make valid part numbers, please contact SynQor for availability. See the Product Summary web page for more options.

*Notes:

Order "F: Floating" option when configuring the AC output for multi-unit combinations of up to 3 units.

Order "R: AC Output Electronic Breaker" option for fault-tolerant, glitch-free parallel systems of up to 32 units with N+M redundancy. The AC output neutral wire will not be connected to the chassis.

Examples:

UPS-1500-H-1U-L1G6D28-E00, UPS-1500-M-1U-L2G5S00-E00
UPS-1500-S-1U-L2G5S00-ECE (230 V output with CE marking)

AC Input	L	47-65 Hz
	W	47-800 Hz
	T	3-Phase 115 V (L-N) 45-800 Hz
	4	3-Phase 440 V (L-L) 47-800 Hz
AC Output Voltage	1	115 Vrms
	2	230 Vrms
AC Output Neutral Wire	G	Grounded
	F	Floating*
	R	AC Output Electronic Breaker*
AC Output Set Point Freq	5	50 Hz
	6	60 Hz
	4	400 Hz
	DC Input / DC2 Output	S
D		DC Input
M		DC2 Out 24 VDC with Droop Share
P		DC2 Out 24 VDC No Share
R		DC2 Out 28 VDC with Droop Share
V		DC2 Out 28 VDC No Share
W		DC2 Out 50 VDC No Share
DC1 Output	00	None
	12	12 V
	15	15 V
	24	24 V
	28	28 V
	50	50 V
Additional Options	-E	Ethernet/SNMP with Configuration Loading
	00	No CE Marking
	CE	CE Marking

UPS-1500-[S,H,M]-1U

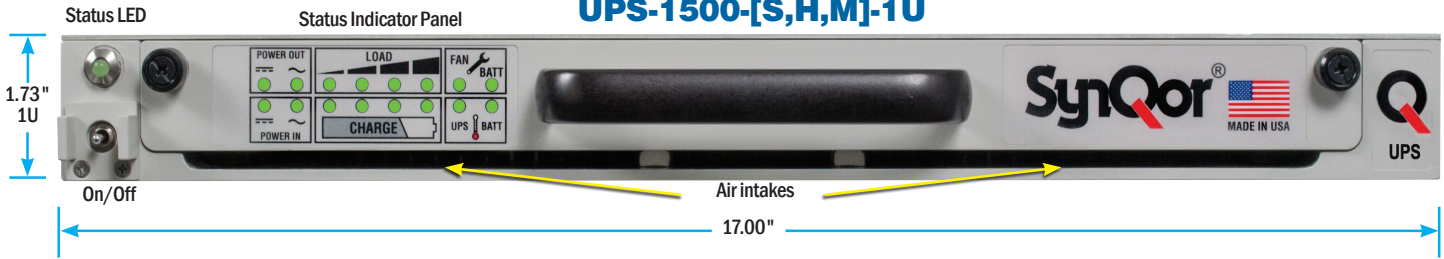

UPS-1500-[S,H,M]-1U with DC Input/DC1 Output Option

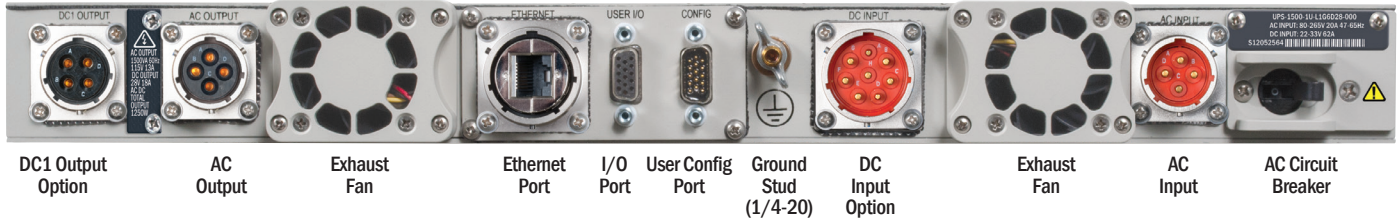

UPS-1500-[S,H,M]-1U with DC1 Output/DC2 Output Option

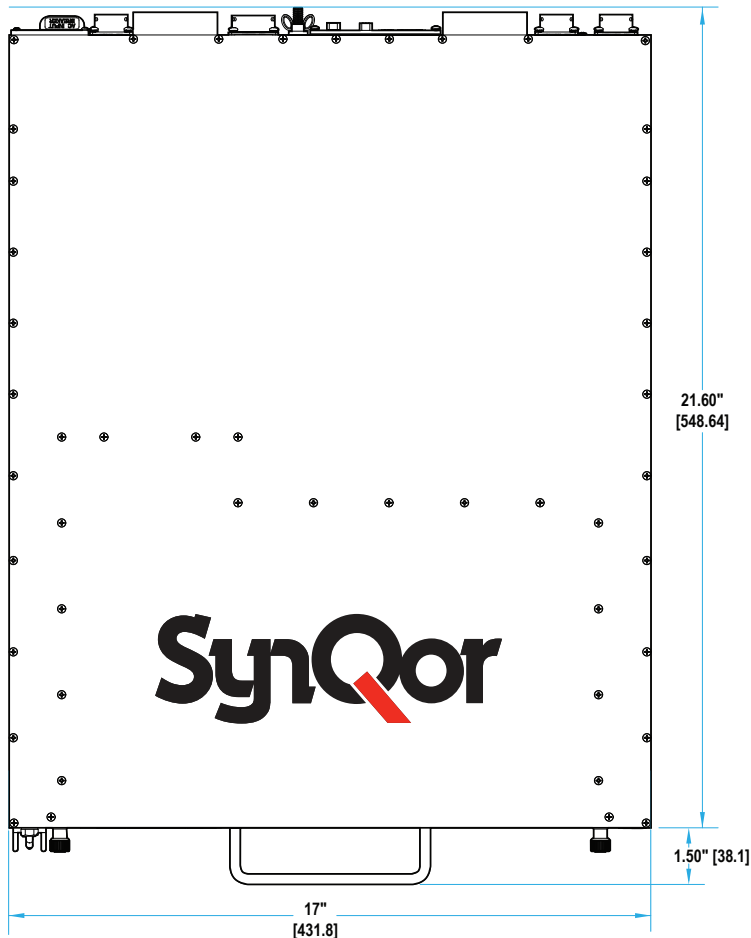

1.25 kW 1U Model



Hot swappable battery pack



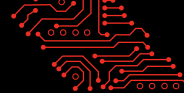

UPS-1500-[S,H,M]-2S

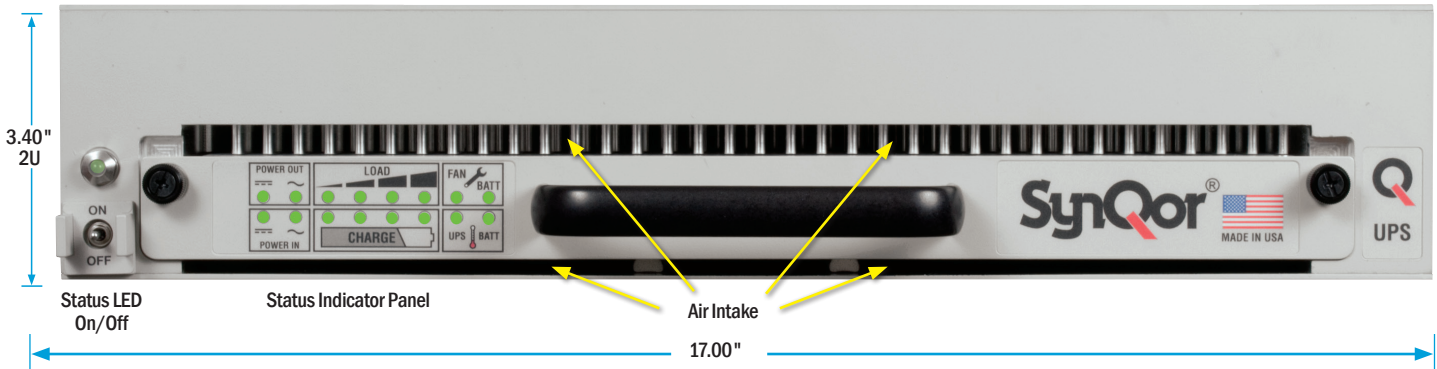

UPS-1500-[S,H,M]-2S with DC Input / DC1 Output Options

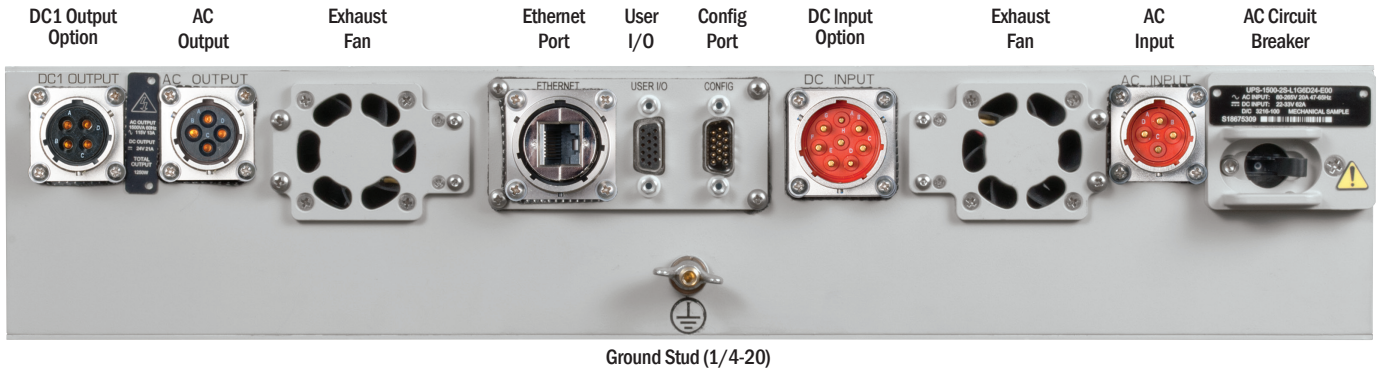

UPS-1500-[S,H,M]-2S with DC1 Output / DC2 Output Option

DC2 Output Option

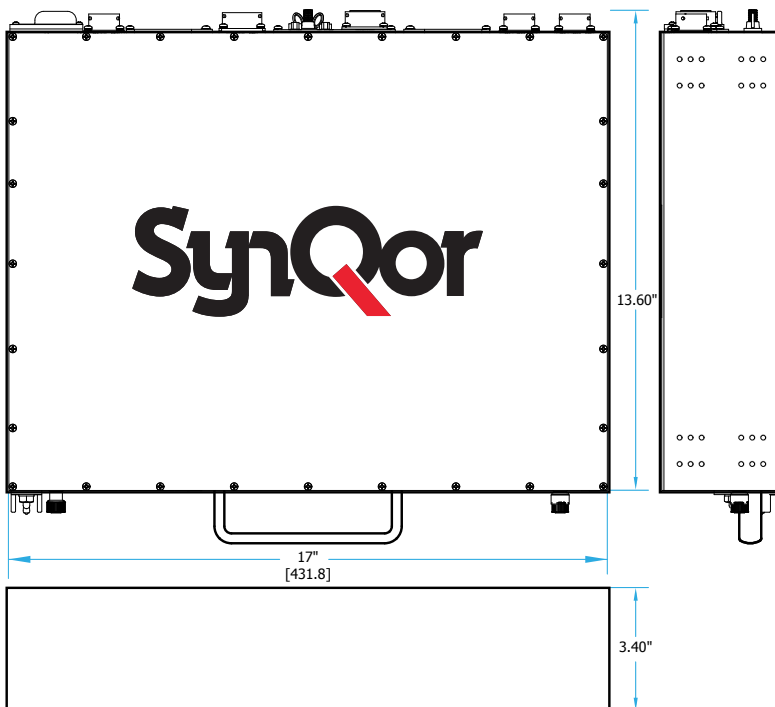

UPS-3000-[S,H,M]-2U

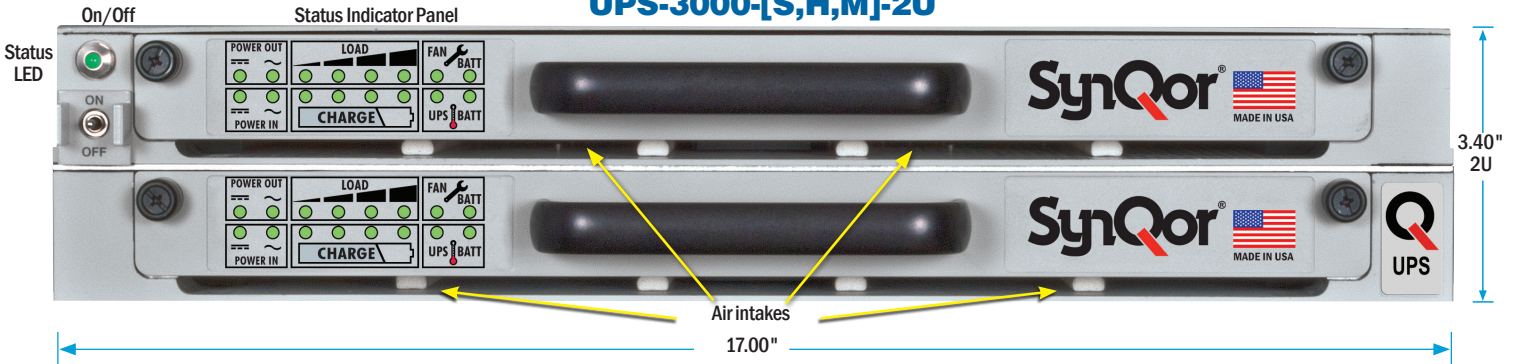

UPS-3000-[S,H,M]-2U with DC Input / DC1 Output Options

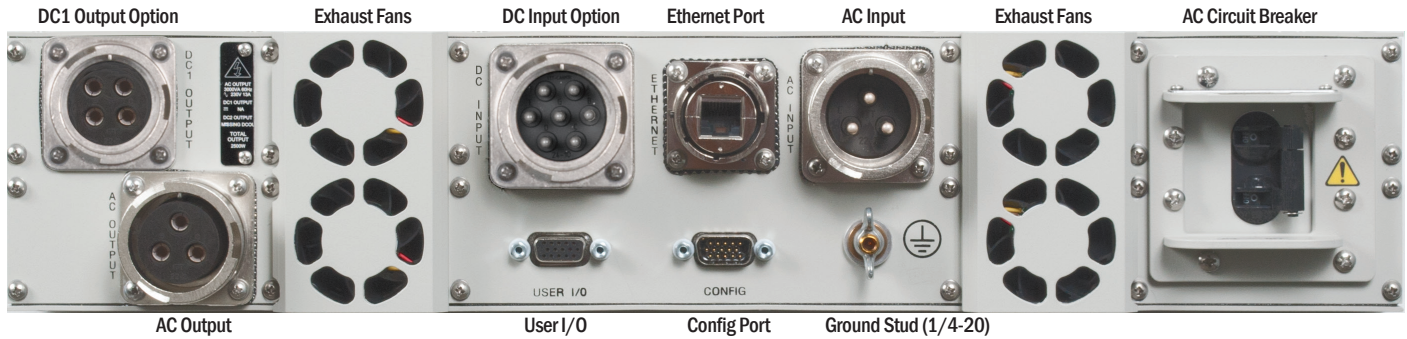

UPS-3000-[S,H,M]-2U with DC1 Output / DC2 Output Options

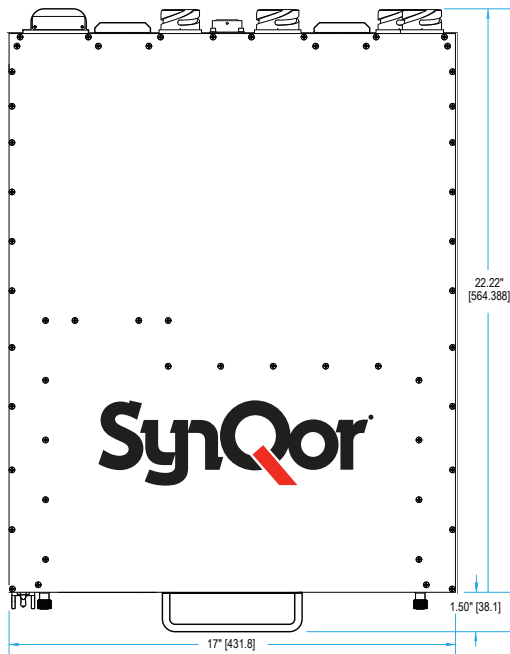
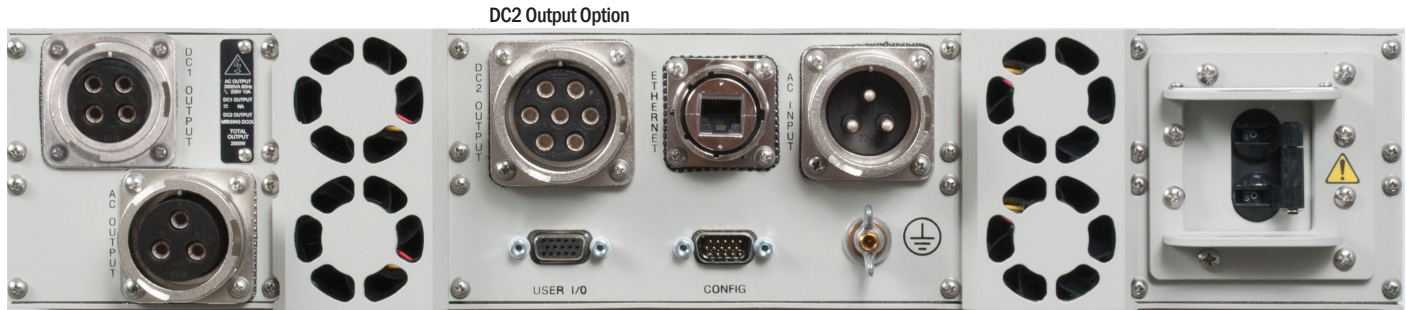



UPS-1500-[S,H,M]-2S

1250 W (1500 VA)

Shallow Rack-Mount Package

>10 Minutes of Run Time at Full Power

Only 33 lbs.



UPS-1500-[S,H,M]-1U

1250 W (1500 VA)

1U High Rack-Mount Package

>10 Minutes Battery Run Time

Only 32 lbs.



UPS-3000-[S,H,M]-2U

2500 W (3000 VA)

2U High Rack-Mount Package

>10 Minutes Battery Run Time

Only 65 lbs.

UPS **MILITARY FIELD-GRADE** Uninterruptible Power Supply

Sealed

Shock-Proof

Weather-Proof

Rugged Construction



DC Output Only Military Field-Grade Uninterruptible Power Supply (UPS-1250)

SynQor's Military Field-Grade Uninterruptible Power Supply units are designed for the extreme environmental and demanding electrical conditions of Military/Aerospace applications. SynQor's UPS incorporates field proven high efficiency designs and rugged packaging technologies. This UPS will accept a wide range of input voltage and frequency values while delivering a well-conditioned DC output to the load. The use of lithium ion batteries permits the lowest profile and lowest weight solution in its power class. It is designed to comply with a wide range of military standards.

UPS Product Features

- Sealed, weather-proof, shock-proof construction
- Military Tough, Die-Cast Aluminum Chassis
- 1250 W DC output power
- >10 minute run-time at full power
- Full power operation -20 °C to +55 °C
- Shallow Rack full power operation -20 °C to +50 °C
- Storage temperature: -40 °C to +65 °C
- True on-line double conversion
- Hot swappable internal battery pack (lithium ion)
- Universal AC input: 80-265 VAC; 47-65 Hz
- Dual input: AC and DC
- Cold-start with no AC or DC input connections
- Power factor correction at AC input
- User I/O, Ethernet and Configuration signal ports

Specification Compliance

UPS units are designed to meet:

- MIL-STD-704F - Aircraft Electrical Power Characteristics
- MIL-STD-1399-300B - Interface Std for Shipboard Systems
- MIL-STD-1275D - Vehicle Electrical Power Characteristics
- MIL-STD-461F - Electromagnetic Interference
- MIL-STD-810G - Environmental Engineering Considerations

Options

- UPS-1250-M-1U / UPS-1250-M-2S >16 minutes of run-time and -40°C operation
- UPS-1250-H-1U / UPS-1250-H-2S >13.5 minutes of run-time
- 2U Shallow rack mount (17.00" x 13.80" x 3.40")
- Wide-range AC input frequency: 47 Hz to 800 Hz
- 270 V DC3 output with:
 - DC1 Auxiliary isolated DC output (up to 500 W)
 - DC2 Auxiliary high power DC output (up to 1250 W) parallelable for higher power
- N+M redundancy



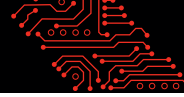

DC Output Only Military Field-Grade Uninterruptible Power Supply (UPS)

DC Output Only Base Model Number	Power	Battery Run-Time@Full Power (80% Power)	Height (W x D x H)	Weight
UPS-1250-S-1U (1 BAT-0200-S Battery Pack)	1250 W	>10 min. (>13 min.)	1U (17" x 22.25" x 1.73")	33 lbs.
UPS-1250-H-1U (1 BAT-0400-H Battery Pack)	1250 W	>13.5 min. (>18 min.)	1U (17" x 22.25" x 1.73")	34.8 lbs.
UPS-1250-M-1U (1 BAT-0400-M Battery Pack)	1250 W	>16 min. (>22 min.)	1U (17" x 22.25" x 1.73")	34.8 lbs.
UPS-1250-S-2S (1 BAT-0200-S Battery Pack)	1250 W	>10 min. (>13 min.)	2U (17" x 13.80" x 3.40")	33 lbs.
UPS-1250-H-2S (1 BAT-0400-H Battery Pack)	1250 W	>13.5 min. (>18 min.)	2U (17" x 13.80" x 3.40")	34.8 lbs.
UPS-1250-M-2S (1 BAT-0400-M Battery Pack)	1250 W	>16 min. (>22 min.)	2U (17" x 13.80" x 3.40")	34.8 lbs.

DC Only Output Base Models	Options				
	AC Input Freq	DC Regulation Type	DC Output Voltage	DC Input	Additional Options
UPS-1250-S-1U- UPS-1250-H-1U- UPS-1250-M-1U- UPS-1250-S-2S- UPS-1250-H-2S- UPS-1250-M-2S-	L W	R P	24 28 48	D00	-E 00 CE

AC Input Freq	L	47-65 Hz
	W	47-800 Hz
DC Regulation	R	Fully Regulated, No Paralleling
	P	Fully Regulated with Paralleling
DC Output	24	24 V Output
	28	28 V Output
	48	48 V Output
DC Input	D00	DC Input
	-E	Ethernet/SNMP
Additional Options	00	No CE Marking
	CE	CE Marking

Not all combinations make valid part numbers, contact SynQor for availability. See the Product Summary web page for more options.

Examples: UPS-1250-S-1U-LR28D00-000, UPS-1250-H-1U-WR28D00-E00,
UPS-1250-M-1U-LR28D00-0CE (with CE mark)

High Voltage Adjustable DC Output Only Military Field-Grade Uninterruptible Power Supply (UPS)

High Voltage Adjustable DC Output Model Number	Power	Battery Run-Time@Full Power (80% Power)	Height (W x D x H)	Weight
UPS-1250-S-1U (1 BAT-0200-S Battery Pack)	1250 W	>10 min. (>13 min.)	1U (17" x 21.60" x 1.73")	32 lbs.
UPS-1250-H-1U (1 BAT-0400-H Battery Pack)	1250 W	>13.5 min. (>18 min.)	1U (17" x 21.60" x 1.73")	33.8 lbs.
UPS-1250-M-1U (1 BAT-0400-M Battery Pack)	1250 W	>16 min. (>22 min.)	1U (17" x 21.60" x 1.73")	33.8 lbs.

High Voltage Adjustable DC Output Base Models	Options				
	AC Input Freq	DC3 Output	DC Input/ DC2 Output	DC1 Output	Additional Options
UPS-1250-S-1U- UPS-1250-H-1U- UPS-1250-M-1U-	L W	270	S D M P R V W	00 12 15 24 28 40 50	-E 00

AC Input Frequency	L	47-65 Hz	
	W	47-800 Hz	
DC3 Output	270	270 V Default, 150-325 VDC	
	S	Not Installed	
DC Output Voltage	D	DC Input	
	M	DC2 Out 24 VDC with Droop Share	
	P	DC2 Out 24 VDC No Droop Share	
	R	DC2 Out 28 VDC with Droop Share	
	V	DC2 Out 28 VDC No Droop Share	
	W	DC2 Out 50 VDC No Droop Share	
	DC Input/ DC2 Output	00	None
		12	12 V
15		15 V	
24		24 V	
28		28 V	
50		50 V	
Additional Options	-E	Ethernet/SNMP with Configuration Loading	
	00	No CE Marking	

Not all combinations make valid part numbers, please contact SynQor for availability.

See the Product Summary web page for more options.

Examples:

UPS-1250-S-1U-L270S12-E00,
UPS-1250-M-1U-L270D00-E00

UPS **MILITARY SHELTER-GRADE** Uninterruptible Power Supply



Military Shelter-Grade Uninterruptible Power Supply (UPS-MS)

SynQor's family of rack-mounted Military Shelter-Grade Uninterruptible Power Supply units are designed for the environmental and electrical conditions of Military applications. SynQor's UPS incorporates proven high efficiency designs and packaging technologies. This UPS will accept a wide range of input voltage and frequency values while delivering a well-conditioned AC output to the load. The use of lithium ion batteries permits the lowest profile and lowest weight solution in its power class. It is designed to comply with a wide range of military standards.

UPS Product Features

- Hot swappable internal battery pack (lithium ion)
- >10 minute run-time at full power
- 1250 W-1500 VA output power
- Full power operation -10 °C to +50 °C
- Storage temperature: -10 °C to +65 °C
- True on-line double conversion
- Universal AC input: 80-265 VAC; 47-65 Hz
- Cold-start with no AC input connections
- Power factor correction at AC input
- Pure sinusoidal AC output voltage
- Handles 0.0 - 1.0 power factor loads and non-linear loads
- User I/O, Ethernet and Configuration signal ports
- Low weight: 42 lbs. (including chassis & batteries)

Specification Compliance

UPS units are designed to meet:

- MIL-STD-1399-300B - Interface Std for Shipboard Systems
- MIL-STD-461F - Electromagnetic Interference
- MIL-STD-810G - Environmental Engineering Considerations

Options

- 115 Vrms or 230 Vrms AC output
- 50 Hz or 60 Hz

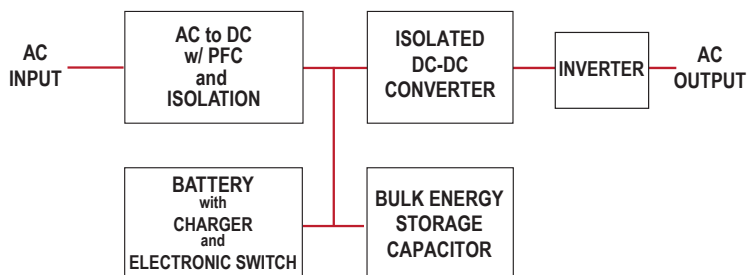



UPS-MS-1500

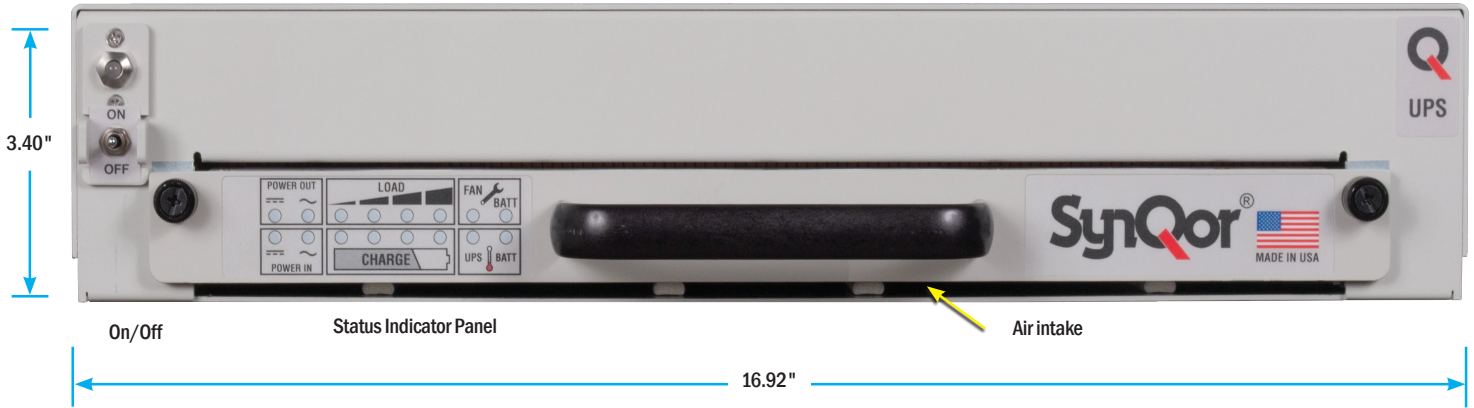

115V AC Output Option Exhaust Fan Ethernet Port User I/O Config Port Ground Exhaust Fan Input

Output Connector Options

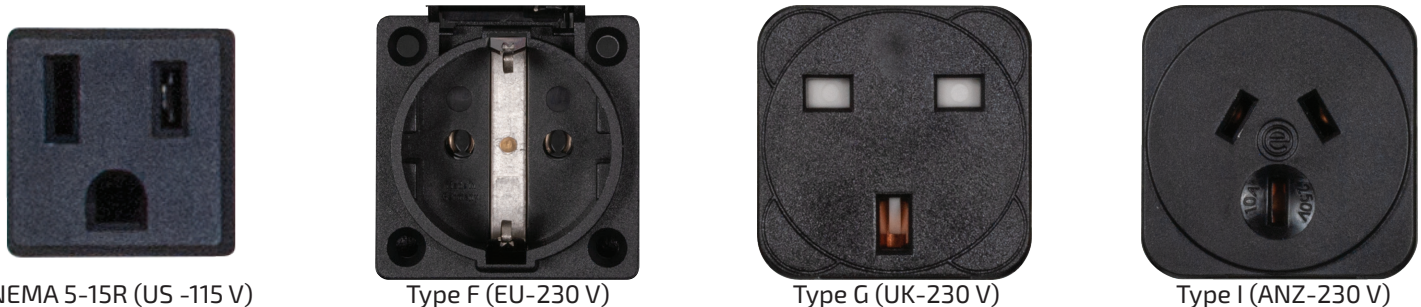

NEMA 5-15R (US -115 V)

Type F (EU-230 V)

Type G (UK-230 V)

Type I (ANZ-230 V)

Military Shelter-Grade Uninterruptible Power Supply (UPS-MS)

AC Base Models				
Model Number	Power	Battery Run-Time @Full Power (80% Power)	Height (W x D x H)	Weight
UPS-MS-1500-S-2U (1 BAT-0200-S Battery Pack)	1250 W 1500 VA	>10 min. (>13 min.)	2U (16.92" x 22.31" x 3.40")	40 lbs.
UPS-MS-1500-H-2U (1 BAT-0400-H Battery Pack)	1250 W 1500 VA	>13.5 min. (>18 min.)	2U (16.92" x 22.31" x 3.40")	41.8

AC Base Models	Options					Options	
	AC Input Frequency	AC Output Voltage	AC Output Neutral Wire	AC Output Set Point Frequency	Additional Options	AC Input Frequency	AC Output Voltage
UPS-MS-1500-S-2U- UPS-MS-1500-H-2U-	L	1	G	5	-E 00 CE CE	L	47-65 Hz
		2		6		1	115 Vrms
		3				2	230 Vrms - EU
		4				3	230 Vrms - UK
						4	230 Vrms - ANZ
						AC Output Neutral Wire	G Grounded
						AC Output Set Point Frequency	5 50 Hz 6 60 Hz
						Additional Options	-E Ethernet/SNMP with Configuration Loading 00 No CE Marking CE CE Marking (230 V only)

Not all combinations make valid part numbers, please contact SynQor for availability.

See the Product Summary web page for more options.

Examples:

UPS-MS-1500-S-2U-L1G6-E00, UPS-MS-1500-S-2U-L2G5-E00

UPS-MS-1500-S-2U-L2G5-ECE (230 V output with CE marking)

MPC MILITARY FIELD-GRADE

Military Power Conditioner



Military Field-Grade Power Conditioner (MPC)

SynQor's Military Field-Grade Power Conditioner units are designed for the extreme environmental and demanding electrical conditions of Military/Aerospace applications. SynQor's MPC incorporates field proven high efficiency designs and rugged packaging technologies. This MPC will accept a wide range of input voltage and frequency values while delivering a well conditioned AC output to the load. It is designed and manufactured in SynQor's USA facilities to comply with a wide range of military standards. Options include two DC outputs, a DC input rated for military 28 VDC sources, and an electronic breaker on the AC output to permit fault-tolerant parallel operation for higher power and/or N+M redundant systems.

MPC Product Features

- Sealed, weather-proof, shock-proof construction
- 1250 W (1500 VA) output power
- Full power operation: -40 °C to +55 °C
- Universal AC input: 80-265 VAC; 47-65 Hz (see options)
- Power factor correction at AC input
- Dual input (AC and optional DC)
- True on-line double conversion
- Pure sinusoidal AC output voltage
- Handles 0.0 - 1.0 power factor loads and non-linear loads
- Up to 3 units can be combined for higher power, voltage or a 3-Phase AC output
- Up to 32 units can be combined to form a higher power fault-tolerant, glitch-free system, perhaps with N+M redundancy, by ordering with the "AC Output Electronic Breaker" option and the appropriate configuration cable
- User I/O, Ethernet and Configuration signal ports

Specification Compliance

MPC units are designed to meet:

- MIL-STD-704F - Aircraft Electrical Power Characteristics
- MIL-STD-1399-300B - Interface Std for Shipboard Systems
- MIL-STD-1275D - Vehicle Electrical Power Characteristics
- MIL-STD-461F - Electromagnetic Interference
- MIL-STD-810G - Environmental Engineering Considerations

Options

- DC input (28 Vnom) for dual source
- Wide-range AC input frequency: 47 Hz to 800 Hz
- 115 Vrms or 230 Vrms AC output
- 50 Hz, 60 Hz, or 400 Hz output
- DC1: Auxiliary isolated DC output (up to 500 W)
- DC2: High power DC output (up to 1250 W) parallelable for higher power
- Shipboard version with floating neutral wire
- N+1 Redundancy



Military Field-Grade Power Conditioner (MPC)

Base Models			
Model Number	Power	Height (W x D x H)	Weight
MPC-1500-1U	1250 W/1500 VA	1U (17.00" x 21.60" x 1.73")	24 lbs.
MPC-1500-1S	1250 W/1500 VA	1U (17.00" x 14.80" x 1.73")	22 lbs.
MPC-3000-2U	2500 W/3000 VA	2U (17.00" x 22.22" x 3.40")	49 lbs.

Base Models	Options							Options	
	AC Input Freq	AC Output Voltage	AC Output Neutral Wire	AC Output Set Point Freq	DC Input / DC2 Output	DC1 Output	Additional Options	AC Input Frequency	AC Output Voltage
MPC-1500-1U- MPC-1500-1S- MPC-3000-2U-	L W	1 2	G F R	5 6 4	S D M P R V W Y	00 12 15 24 28 40 50	-E 00 CE	L 47- 65 Hz W 47-800 Hz	1 115 Vrms 2 230 Vrms
								G Grounded F Floating* R AC Output Electronic Breaker*	
								5 50 Hz 6 60 Hz 4 400 Hz	
								S Not Installed D DC Input M DC2 Out 24 VDC with Droop Share P DC2 Out 24 VDC No Share (MPC-1500) R DC2 Out 28 VDC with Droop Share V DC2 Out 28 VDC No Share (MPC-1500) W DC2 Out 50 VDC No Share (MPC-1500) Y DC2 Out 50 VDC with Droop Share	
								00 None 12 12 V 15 15 V 24 24 V 28 28 V 40 40 V 50 50 V	
								-E Ethernet/SNMP with Configuration Loading 00 No CE Marking CE CE Marking	

Not all combinations make valid part numbers, please contact SynQor for availability. See the Product Summary web page for more options.

*Notes:

Order "F: Floating" option when configuring the AC output for multi-unit combinations of up to 3 units.

Order "R: AC Output Electronic Breaker" option for fault-tolerant, glitch-free parallel systems of up to 32 units with N+M redundancy.

The AC output neutral wire will not be connected to the chassis.

Examples:

MPC-1500-1U-L1G6D28-E00, MPC-1500-1U-L2G5S00-E00

MPC-3000-2U-L2G5S00-ECE (230 V output with CE marking)

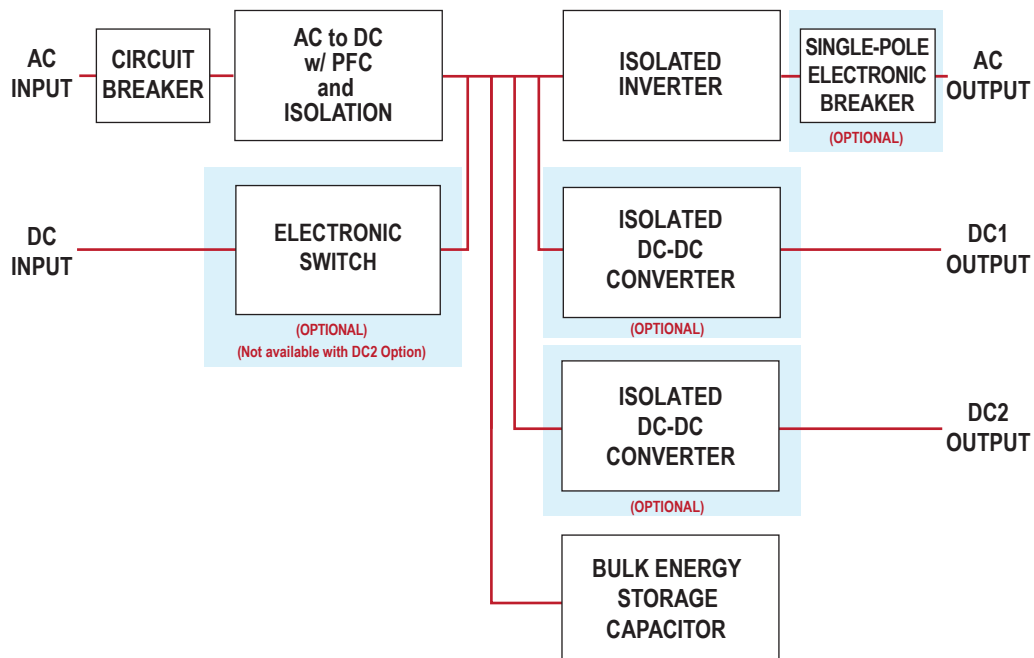

MPC-1500-1U & MPC-1500-1S

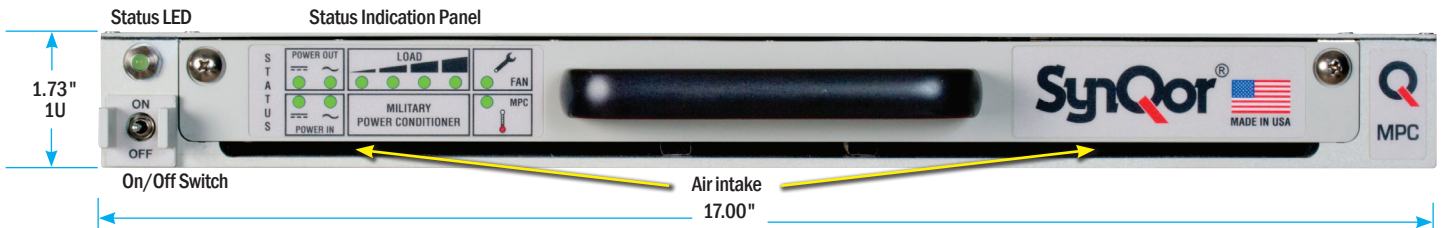

MPC-1500-1U & MPC-1500-1S with DC Input/DC1 Output Options

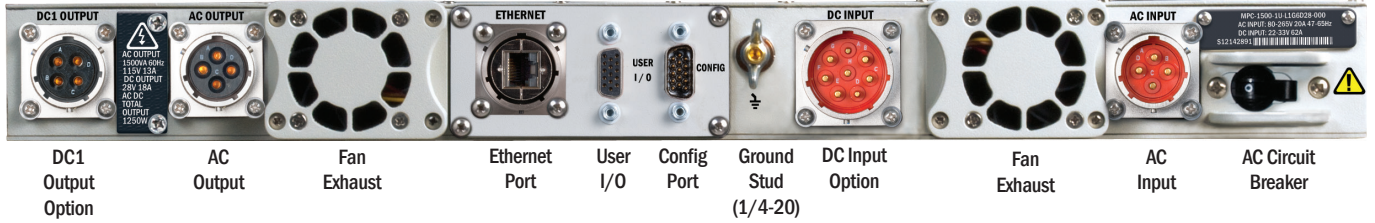

MPC-1500-1U & MPC-1500-1S with DC1 Output/DC2 Output Options

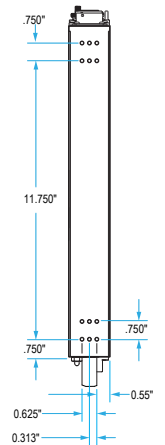
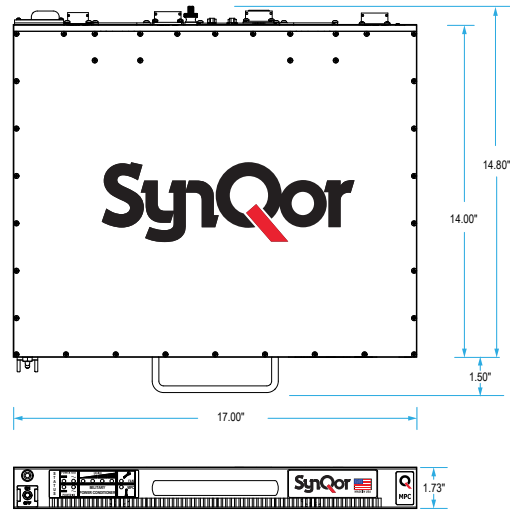
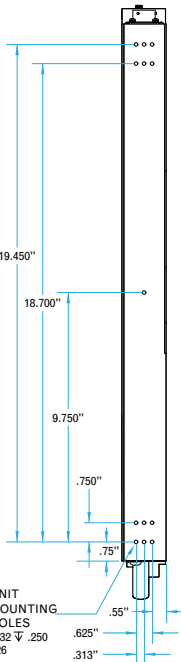
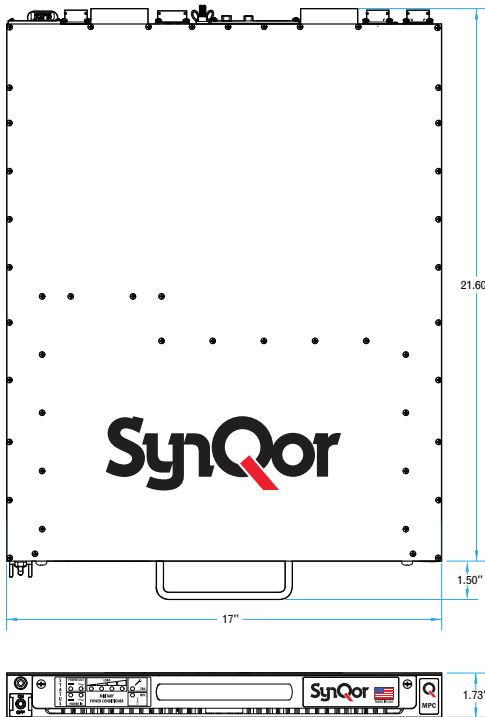

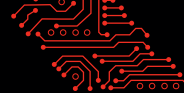

MPC-3000-2U

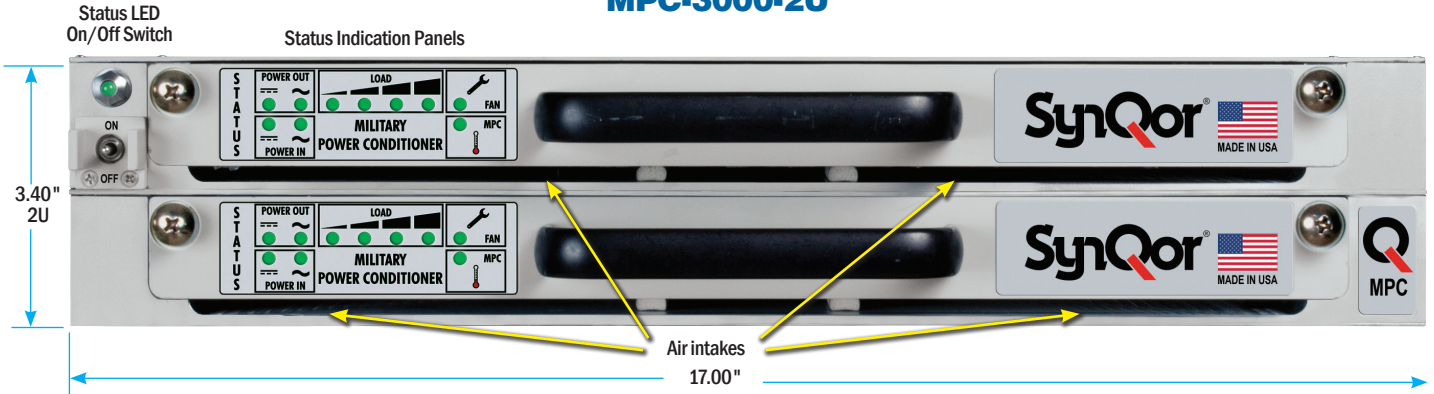

MPC-3000-2U Units with DC Input /DC1 Output Options

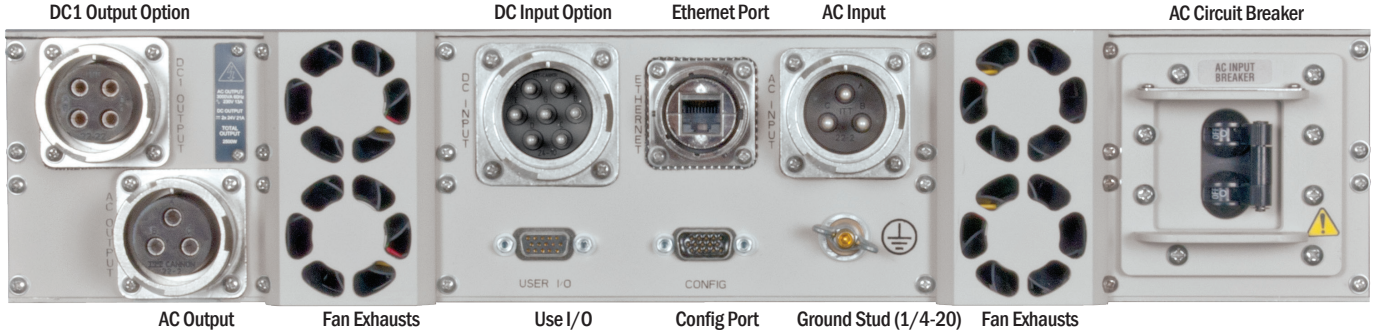

MPC-3000-2U Units with DC1 Output /DC2 Output Options

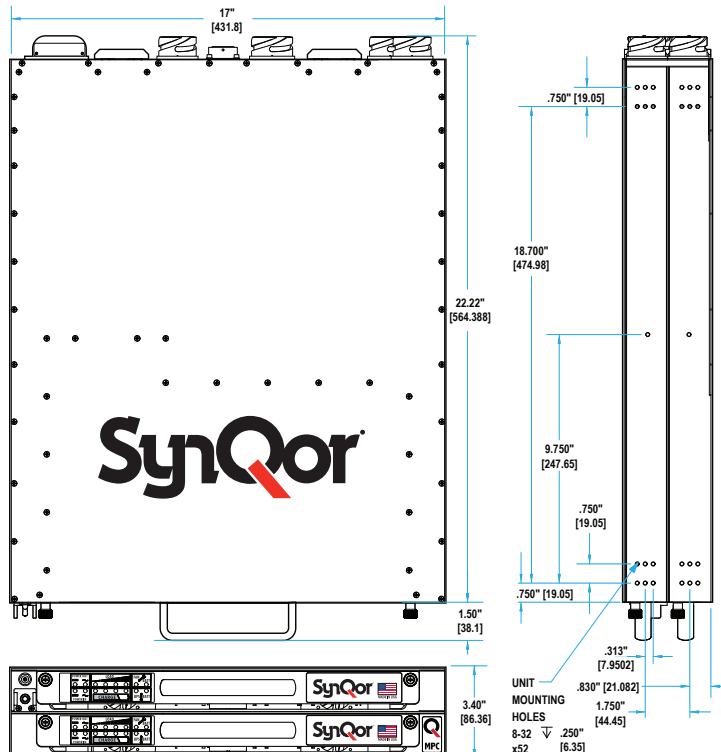
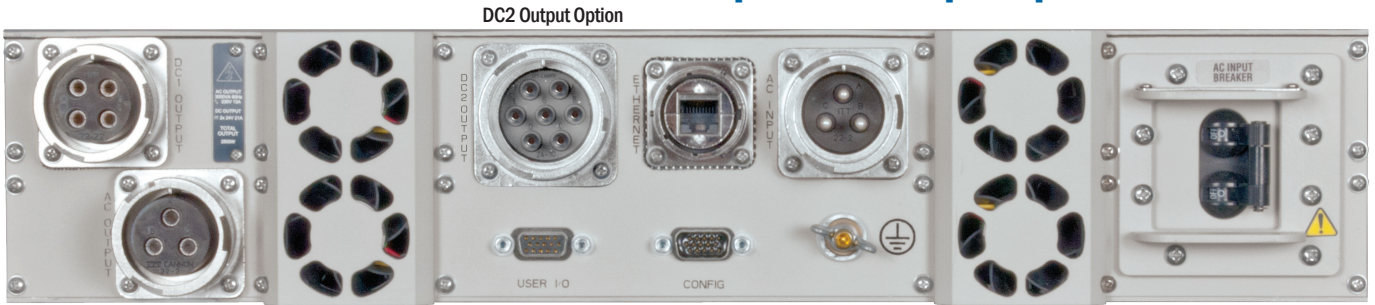

MPC MILITARY FIELD-GRADE

Military Power Conditioner



DC Output Only Military Field-Grade Power Conditioner (MPC-1250)

SynQor's Military Field-Grade Power Conditioner units are designed for the extreme environmental and demanding electrical conditions of Military/Aerospace applications. SynQor's MPC incorporates field proven high efficiency designs and rugged packaging technologies. This MPC will accept a wide range of input voltage and frequency values while delivering a well conditioned DC output to the load. It is designed to comply with a wide range of military standards.

MPC Product Features

- Sealed, weather-proof, shock-proof construction
- 1250 W DC output power
- Full power operation: -40 °C to +55 °C
- Universal AC input: 80-265 VAC; 47-65 Hz (see options)
- Power factor correction at AC input
- Dual input (AC and DC)
- True on-line double conversion
- User I/O, Ethernet and Configuration signal ports
- Low weight: 22 lbs.

Specification Compliance

MPC units are designed to meet:

- MIL-STD-1399-300 - Interface Shipboard
- MIL-STD-810 - Environmental Engineering
- MIL-STD-461 - Electromagnetic Interference
- MIL-STD-704 - Aircraft Electrical Power
- MIL-STD-1275 - Vehicle Electrical Power

Options

- Constant Current Overload Protection suitable for Lead-acid Battery Charging applications
- Fully Regulated or Parallelable DC Output
- Wide-range AC input frequency: 47 Hz to 800 Hz

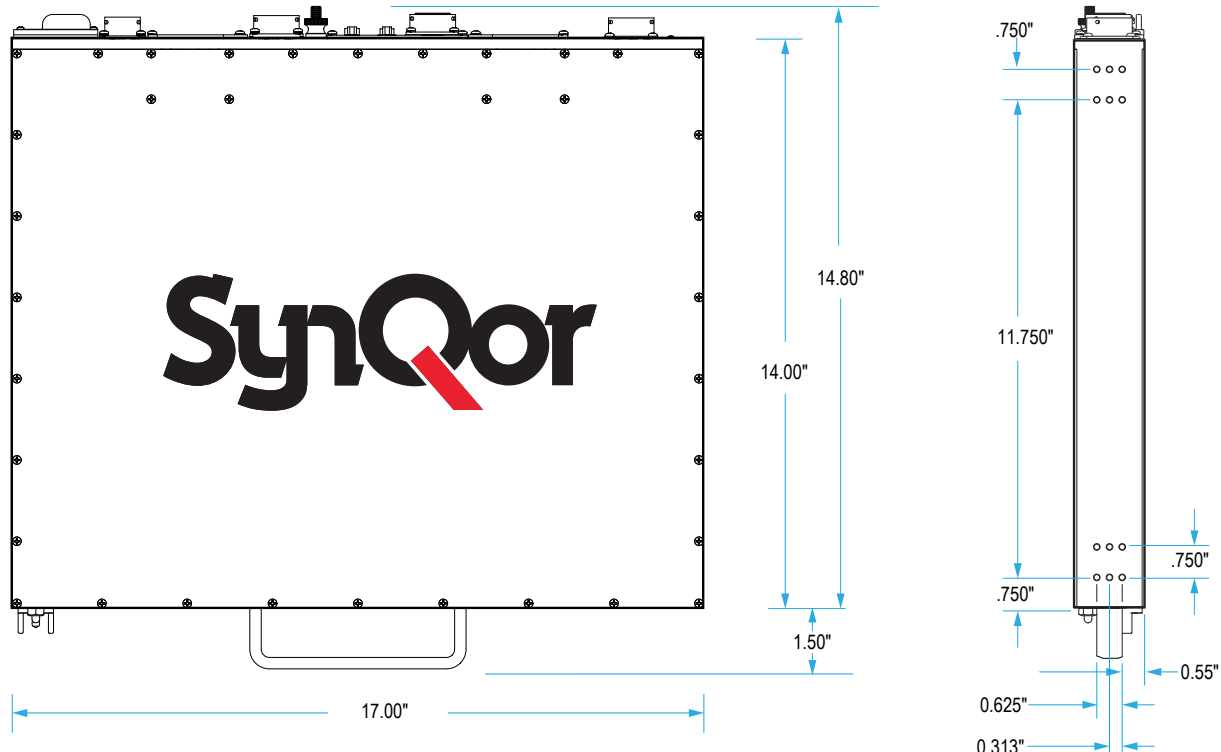



MPC-1250-1S

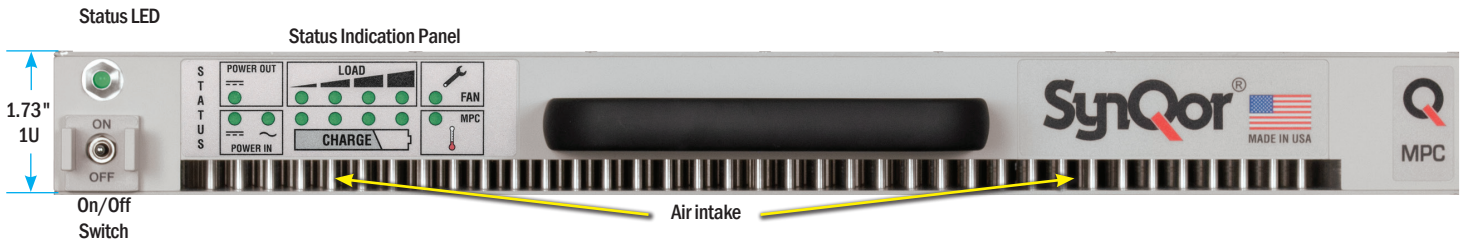

MPC-1250-1S with AC & DC Input / DC Output

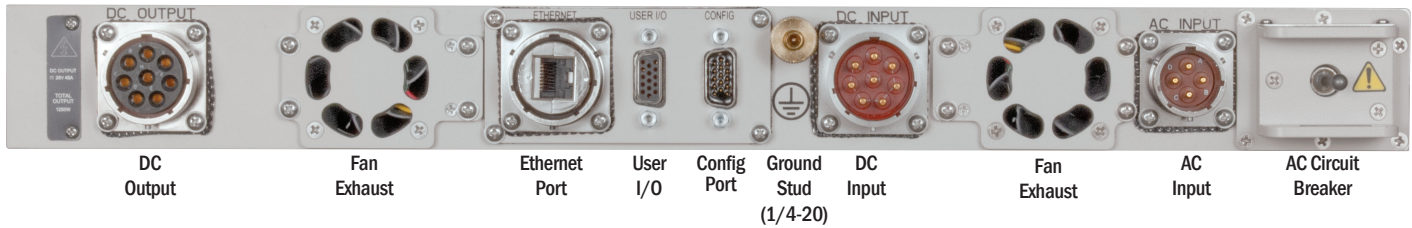

DC Output Only Military Field-Grade Power Conditioner (MPC)

Base Model			
Model Number	Power	Height (W x D x H)	Weight
MPC-1250-1S	1250 W	1U (17.00" x 14.80" x 1.73")	22 lbs.

Base Models	Options				
	AC Input Frequency	DC Regulation Type	DC Output Voltage	DC Input	Additional Options
MPC-1250-1S-	L W	R P C	24 28 48	D00	-E 00 CE

Options	
AC Input Frequency	L 47-65 Hz W 47-800 Hz
DC Output Type	R Fully Regulated Output P Parallelable Regulated Output C Constant Current Overload Protection
DC Output Voltage	24 24 V Output 28 28 V Output* 48 48 V Output
DC Input	D00 DC Input
Additional Options	-E Ethernet/SNMP with Configuration Loading
	00 No CE Marking
	CE CE Marking

Not all combinations make valid part numbers, please contact SynQor for availability.

See the Product Summary web page for more options.

*Notes: Order "P: Parallelable" option to place multiple MPC units in parallel

*Select 28V output option when ordering Constant Current regulation type

Examples: MPC-1250-1S-LR28D00-E00

MPC-1250-1S-LP28D00-ECE (Parallelable with CE marking)

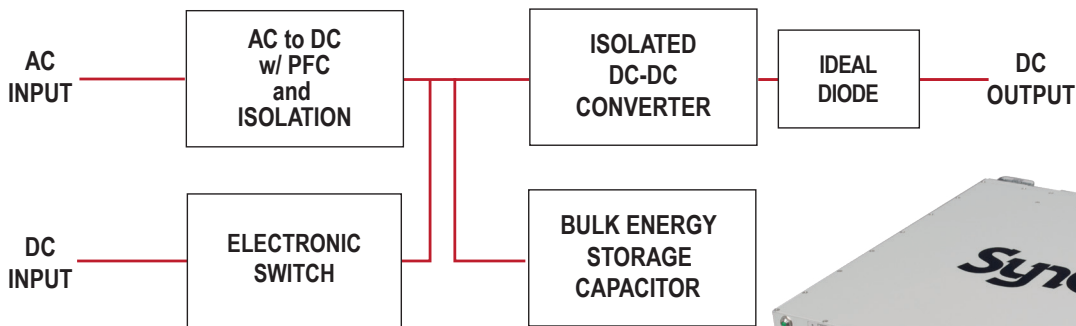



MPS MILITARY FIELD-GRADE

Military Power Supply

Military Field-Grade Power Supply (MPS) & Programmable Power Supply (MPPS)

SynQor’s Military AC-DC Power Supply units are designed for the extreme environmental and demanding electrical conditions of Military/Aerospace applications. SynQor’s MPS & MPPS incorporate field proven high efficiency designs and rugged packaging technologies. The MPS & MPPS will accept a 3-Phase input with a wide range of input voltage and frequency values. The MPS delivers a well-conditioned continuous 4000 W (5250 W transient), DC semi-regulated output. The output voltage droops for system stability and for load sharing when units are in parallel. The MPPS delivers a well-conditioned output to the load. The output voltage and output current limit can be adjusted on the fly via RS-232 or web interface. Current sharing allows multiple units to be used in parallel. The MPS & MPPS are designed to comply with a wide range of military standards in SynQor’s USA headquarters and manufacturing facilities.

MPS/MPPS Product Features

- Sealed, weather-proof, shock-proof construction
- 4000 W output power
- Adjustable output voltage and output current limit (MPPS)
- Semi-Regulated 28 V-48 V output voltages (MPS)
- Full power operation: -40 °C to +55 °C
- 3-Phase input: 80-265 Vrms line-to-line; 47-800 Hz (MPS)
- 3-Phase input: 85-265 Vrms line-to-line; 47-800 Hz (MPPS)
- Power factor correction at AC input
- Up to 8 units can be combined for higher power
- User I/O, Ethernet and Configuration signal port
- Synchronized start and stop of multiple units
- Battle Mode for over-temperature events
- 1U high rack-mount unit (17.00" x 20.42")
- Low weight: 28 lbs.

Specification Compliance

MPS & MPPS units are designed to meet:

- MIL-STD-704F - Aircraft Electrical Power Characteristics
- MIL-STD-1399-300B - Interface Std for Shipboard Systems
- MIL-STD-461F - Electromagnetic Interference
- MIL-STD-810G - Environmental Engineering Considerations

3-Phase Military Field-Grade AC-DC Power Supply (MPS)

Family	Output Power	Height	AC Input Phase #	AC Input Frequency	DC Output Voltage @ Full Load*	Output Regulation	Network
MPS	4000: 4000 W	1U: 1.73"	3: 3-Phase	W: 47-800 Hz	2D: 28 V 2E: 30 V 4B: 48 V	S00: Semi-regulated	E00: Ethernet/SNMP

Example: MPS-4000-1U-3W2ES00-E00 For valid part numbers, refer to the website or contact your local sales representative.

*Approximate output voltage at full load, output voltage has Droop

3-Phase Military Field-Grade AC-DC Programmable Power Supply (MPPS)

Family	Output Power	Height	AC Input Phase #	AC Input Frequency	DC Output Voltage @ Full Load	Output Current Range	Network
MPPS	4000: 4000 W	1U: 1.73"	3: 3-Phase	W: 47-800 Hz	28: 0-35 V 48: 0-55 V 72: 0-80 V	150: 0-150 A 120: 0-120 A 078: 0- 78 A	E00: Ethernet/SNMP

Example: MPPS-4000-1U-3W28-150-E00 For valid part numbers, refer to the website or contact your local sales representative.



MPS-4000-1U and MPPS-4000-1U

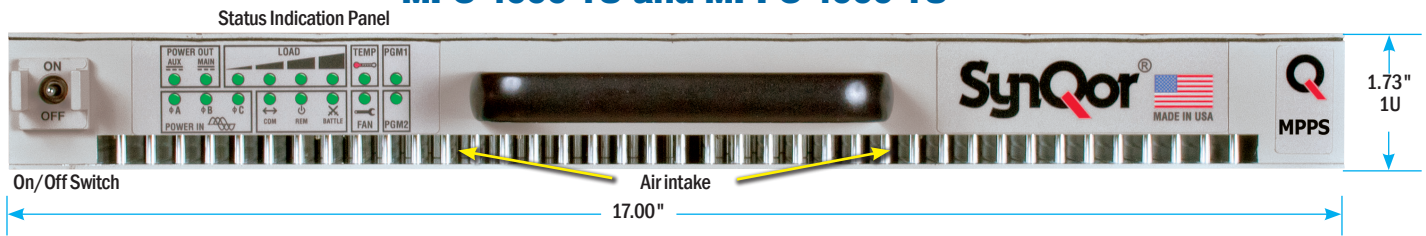

MPS-4000-1U with AC Input

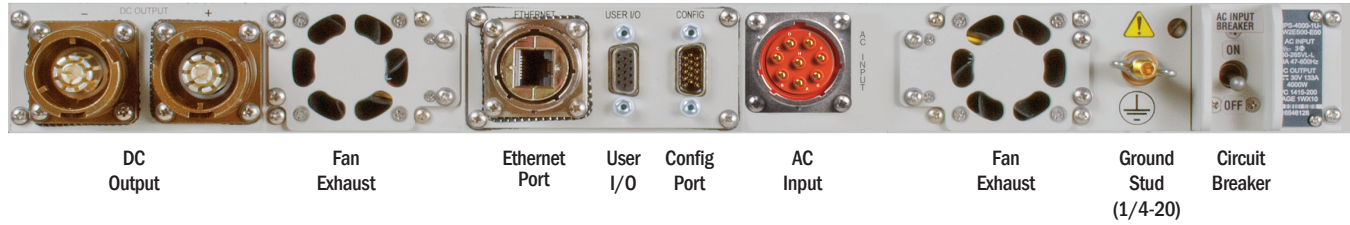

MPPS-4000-1U with AC Input

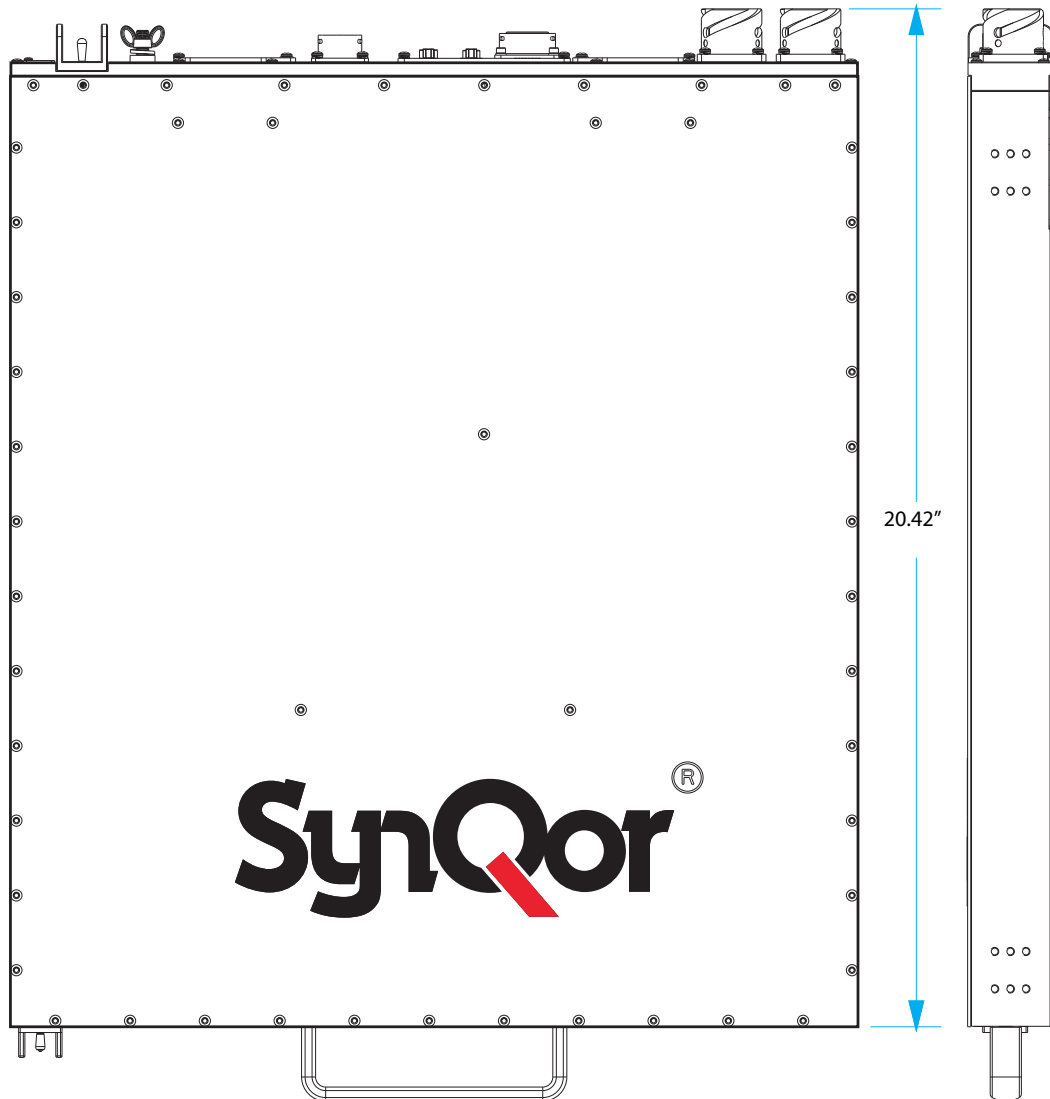
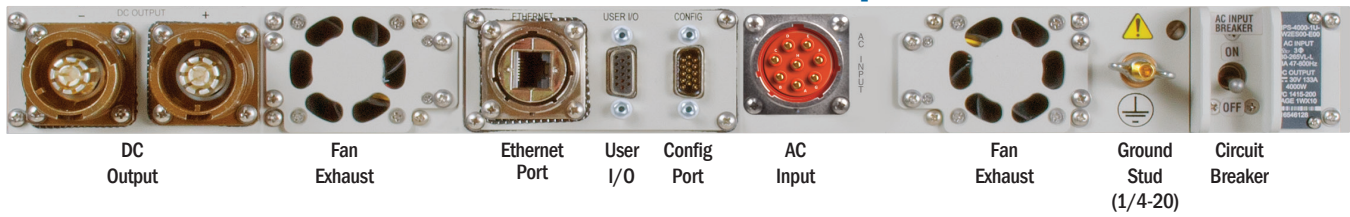



MPPS MILITARY FIELD-GRADE

Military Programmable Power Supply

Military Field-Grade 440 V, 3-Phase Programmable Power Supply (MPPS)

SynQor's Military Field-Grade Programmable Power Supply units are designed for the extreme environmental and demanding electrical conditions of Military/Aerospace applications. SynQor's MPPS-4000-270 incorporates field proven high efficiency designs and rugged packaging technologies. This MPPS will accept a 3-Phase AC input and change it to a tightly regulated high voltage DC output using a two-stage DC link isolated topology. The output is programmable by the user from 25-400 V. Full output power is available from 175-400 V. The output current limit is also programmable by the user for battery charging applications. The MPPS-4000-270 is designed to comply with a wide range of military standards. Parallel up to 32 units for increased power, and/or N+M redundancy.

MPPS 440 V, 3-Phase 270 V Features

- Sealed, weather-proof, shock-proof construction
- 3-Phase 360-528 Vrms L-L Δ input (draws balanced currents)
- 47-65 Hz input frequency range
- Programmable output voltage 25 - 400 V
- Full Power available from 175 - 400 V
- Programmable current limit 0.2 - 25 A
- Tightly regulated, low noise DC output
- 4000 W continuous output power; 15 s transient to 4500 W
- Appropriate for pulsed loads, high capacitance loads, battery charging
- Full power operation: -40 °C to +55 °C
- Up to 32 units can be combined for higher power , and/or N+M redundancy
- User I/O, Ethernet and Configuration signal ports
- Battle Mode for over-temperature events
- 1U high rack mount unit (17.00"W x 22.42"D x 1.73"H)
- Low weight: 33 lbs.

Specification Compliance

MPPS units are designed to meet:

- MIL-STD-1399-300B - Interface Std for Shipboard Systems
- MIL-STD-461F - Electromagnetic Interference
- MIL-STD-810G - Environmental Engineering Considerations

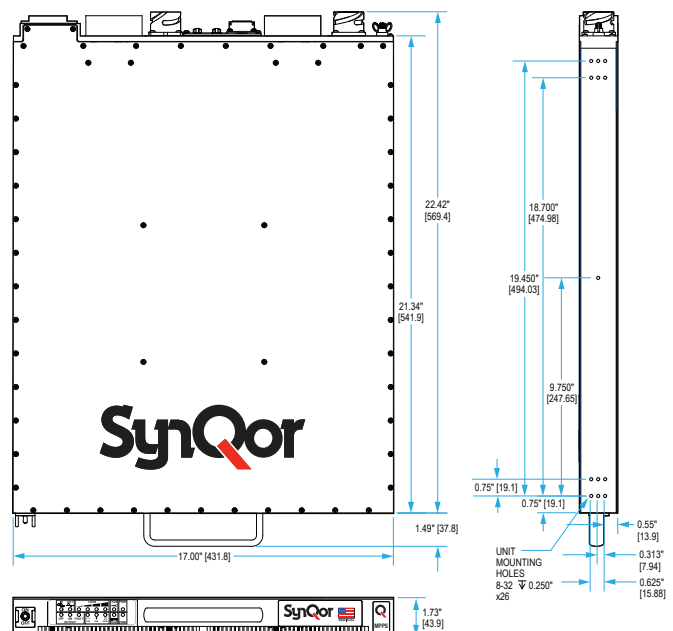



MPPS-4000-270-1U

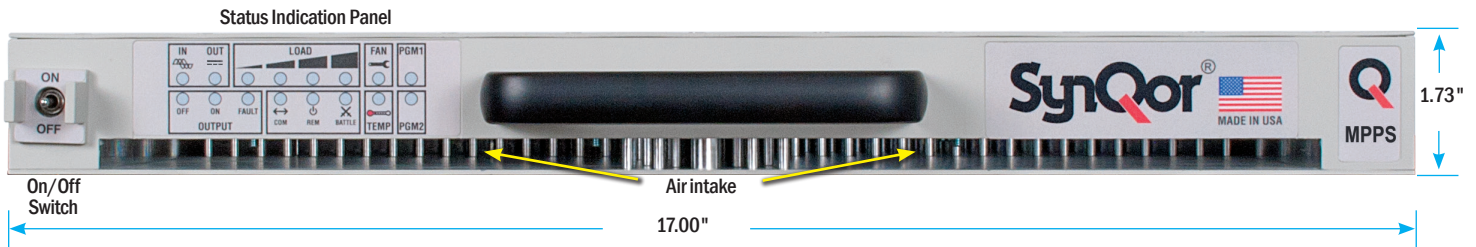

MPPS-4000-270-1U with AC Input

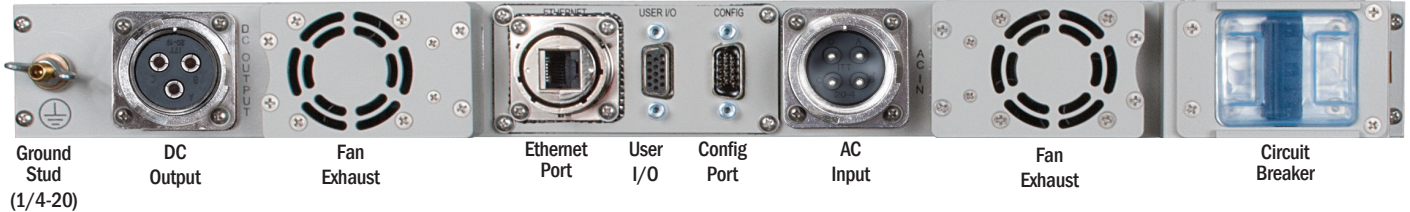

Base Models			
Model Number	Power	Height (W x D x H)	Weight
MPPS-4000-1U	4000 W	1U (17.00" x 22.42" x 1.73")	33 lbs.

Base Models	Options						Options		
	Line to Line Input Voltage	Number of Input Phases	Input Freq Range	Output Voltage	Output Config	Additional Options	Line to Line Input Voltage		
MPPS-4000-1U-	4	T	L	270	S	-E00	4	360-528 V	
							T	3-Phase	
							L	47-65 Hz	
							270	270	Nominal Output Voltage
							S	DC Programmable, 25 - 400 Vdc 0.2 - 25 A	
							-E00	Ethernet/SNMP with Config Loading	

Example:
MPPS-4000-1U-4TL270S-E00



MINV

MILITARY FIELD-GRADE

Military Power Inverter

Military Field-Grade Power Inverter (MINV)

SynQor's Military Inverter units are designed for the extreme environmental and demanding electrical conditions of Military/Aerospace applications. SynQor's MINV incorporates field proven high efficiency designs and rugged packaging technologies. This MINV will accept a wide range of steady-state and transient DC input voltage values while delivering a well-conditioned AC output to the load. Options include a selection of output voltage amplitudes, frequencies, and an electronic breaker on the AC output to permit fault-tolerant parallel operation for higher power and/or N+M redundant systems.

MINV Product Features

- Sealed, weather-proof, shock-proof construction
- 4000 W (5000 VA) output power
- Full power operation: -40 °C to +55 °C
- 28 V DC Input & 270 V DC Input
- Pure sinusoidal AC output voltage
- Handles 0.0 - 1.0 power factor loads and non-linear loads
- Up to 32 units can be combined for higher power, voltage or a 3-Phase AC output
- Up to 32 units can be combined to form a higher power fault-tolerant, glitch-free system, perhaps with N+M redundancy, by ordering with the "AC Output Electronic Breaker" option and the appropriate configuration cable
- Battle Mode for over-temperature events
- User I/O, Ethernet and Configuration signal ports

Options

- 115 Vrms or 230 Vrms AC output
- 50 Hz, 60 Hz, or 400 Hz AC output
- Shipboard version with floating neutral wire
- N+1 Redundancy

Specification Compliance

MINV-4000 units are designed to meet:

- MIL-STD-1399-300B - Interface Std for Shipboard Systems
- MIL-STD-810G - Environmental Engineering Considerations
- MIL-STD-461F - Electromagnetic Interference
- MIL-STD-704F - Aircraft Electrical Power Characteristics
- MIL-STD-1275D - Vehicle Electrical Power Characteristics

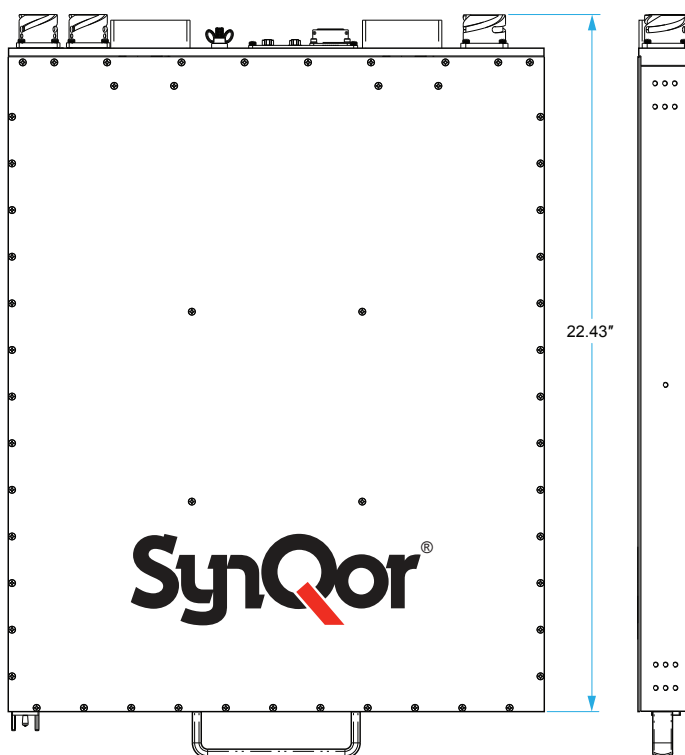



MINV-4000-1U

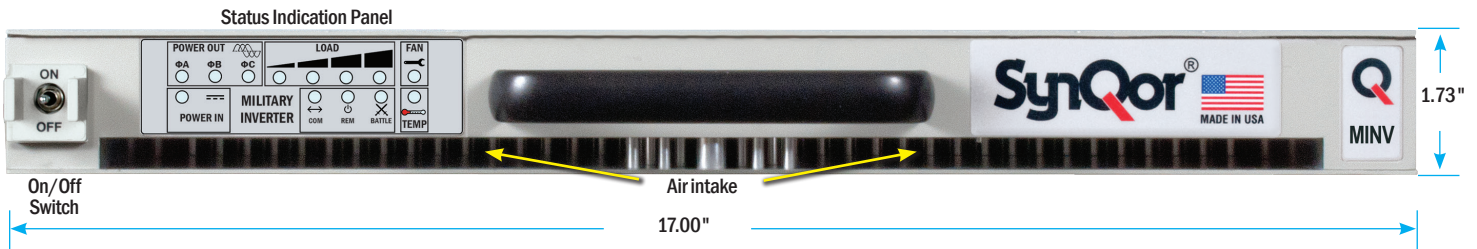

28 V Rear Panel

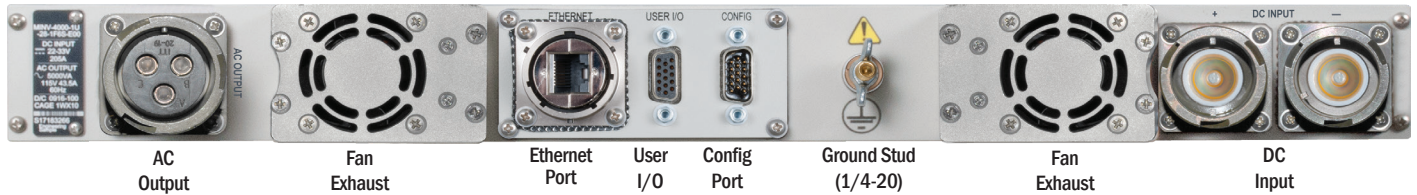

270 V Rear Panel

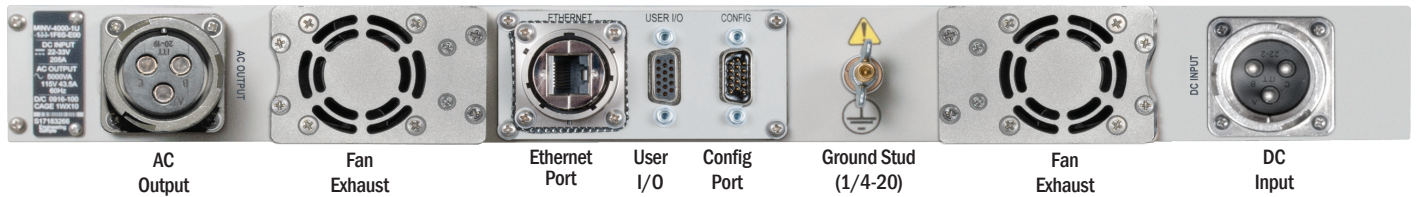

Military Field-Grade Power Inverter (MINV)

Base Model				
Model Number	Power	Nominal DC Input Voltage	Height (W x D x H)	Weight
MINV-4000-1U	4000 W 5000 VA	28 V	1U (17.00" x 22.43" x 1.73")	32 lbs.
MINV-4000-1U	4000 W 5000 VA	270 V	1U (17.00" x 22.42" x 1.73")	33 lbs.

Base Model	Options					
	DC Input Voltage	AC Output Voltage	AC Output Neutral Wire	AC Output Set Point Freq	Output Config	Additional Options
MINV-4000-1U-	28 270	1 2	G F R	5 6 4	S	-E 00 CE

Options	
DC Input Voltage	28 20 - 33 V 270 160-330 V, 150-350 V Transient
AC Output Voltage	1 115 Vrms 2 230 Vrms
AC Output Neutral Wire	G Grounded F Floating* R AC Output Electronic Breaker*
AC Output Set Point Freq	5 50 Hz 6 60 Hz 4 400 Hz
Output Config	S Single-Phase Output
Additional Options	-E Ethernet/SNMP with Configuration Loading 00 No CE Marking CE CE Marking (28 Vout only)

Not all combinations make valid part numbers, please contact SynQor for availability. See the Product Summary web page for more options.

*Notes:

Order "F: Floating" option when configuring the AC output for multi-unit combinations of up to 3 units.

Order "R: AC Output Electronic Breaker" option for fault-tolerant, glitch-free parallel systems of up to 32 units with N+M redundancy. The AC output neutral wire will not be connected to the chassis.

Examples:

MINV-4000-1U-28-1G6S-E00

MINV-4000-1U-28-2G5S-ECE (230 V output with CE marking)

MAC **MILITARY FIELD-GRADE** Military AC Phase/Frequency Changer



Military Field-Grade AC Phase/Frequency Changer (MAC)

SynQor's Military Field-Grade AC Phase/Frequency Changer units are designed for the extreme environmental and demanding electrical conditions of Military/Aerospace applications. SynQor's MAC incorporates field proven high efficiency designs and rugged packaging technologies. This MAC will accept a 3-Phase AC input and change it to a well-conditioned Single-Phase AC output using a two-stage DC link isolated topology. It is designed and manufactured in SynQor's USA facilities to comply with a wide range of military standards. Options include a selection of output voltage amplitudes, frequencies and an electronic breaker on the AC output to permit fault-tolerant parallel operation for higher power and/or N+M redundant systems.

MAC Product Features

- Sealed, weather-proof, shock-proof construction
- Two-stage, DC link isolated topology
- 4000 W (5000 VA) output power; 15 s transient to 5250 W (6500 VA)
- Full power operation: -40 °C to +55 °C
- 3-Phase 360-528 Vrms L-L Δ input (draws balanced currents)
- 47-65 Hz input frequency range
- Pure sinusoidal AC output voltage
- Handles 0.0–1.0 power factor loads and non-linear loads
- Up to 32 units can be combined for higher power, voltage, a 3-Phase AC output, or a higher power fault-tolerant, glitch-free system, perhaps with N+M redundancy, by ordering with the "AC Output Electronic Breaker" option and the appropriate configuration cable
- User I/O, Ethernet and Configuration signal ports
- Battle Mode for over-temperature events

Options

- 115 Vrms or 230 Vrms AC output
- 50 Hz, 60 Hz, or 400 Hz AC output (software selectable)
- Shipboard version with floating output neutral wire
- N+1 Redundancy

Specification Compliance

MAC-4000 units are designed to meet:

- MIL-STD-1399-300B - Interface Std for Shipboard Systems
- MIL-STD-810G - Environmental Engineering Considerations
- MIL-STD-461F - Electromagnetic Interface

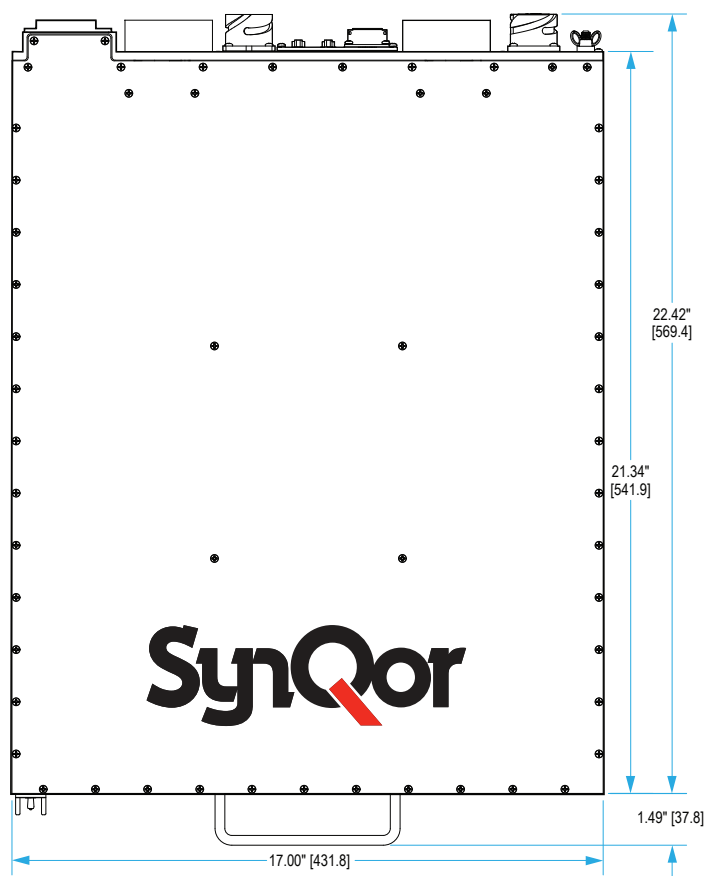

Military AC Phase/Frequency Changer

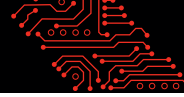

MAC-4000-1U UNIT

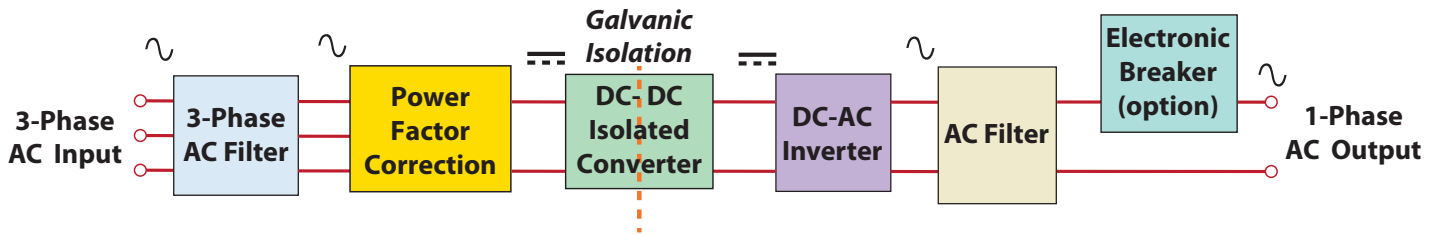
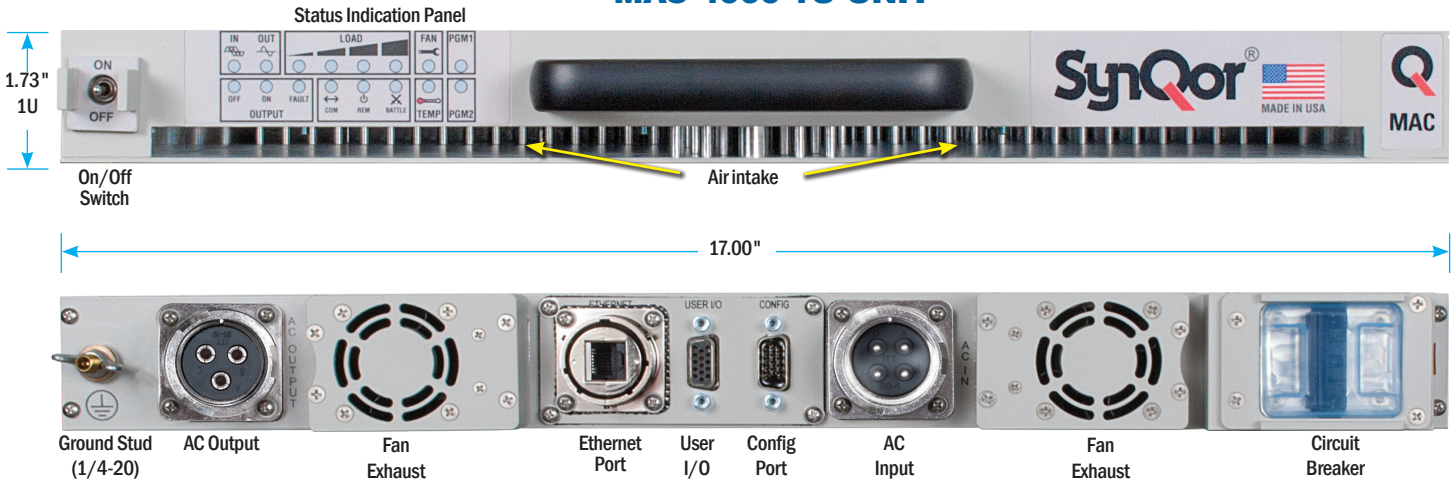

Military Field-Grade Phase/Frequency Changer (MAC)

Base Model			
Model Number	Power	Height (W x D x H)	Weight
MAC-4000-1U (1 Standard Battery Pack)	4000 W 5000 VA	1U (17.00" x 22.42" x 1.73")	33 lbs.

Base Models	Options								
	Line to Line Input Voltage	Number of Input Phases	Input Freq Range	AC Output Voltage	AC Output Neutral Wire	AC Output Set Point Freq	Output Config	Additional Options	
MAC-4000-1U-	1 4	T	L W	1 2	G F R	5 6 4	S	-E	00 CE

Options	
Line to Line Input Voltage	1 85-147 V L-N/270 Vdc 4 360-528 V L-L
Number of Input Phases	T 3-Phase
Input Freq Range	L 47-65 Hz W 0-800 Hz
AC Output Voltage	1 115 V 2 230 V
AC Output Neutral Wire	G Grounded F Floating* R AC Output Electronic Breaker*
AC Output Set Point Freq	5 50 Hz 6 60 Hz 4 400 Hz
Output Config	S One Single-Phase Output
Additional Options	-E Ethernet/SNMP with Config Loading
	00 No CE Marking CE CE Marking

Not all combinations make valid part numbers, please contact SynQor for availability. See the Product Summary web page for more options.

*Notes:

Order "F: Floating" option when configuring the AC output for multi-unit combinations of up to 32 units.

Order "R: AC Output Electronic Breaker" option for fault-tolerant, glitch-free parallel systems of up to 32 units with N+M redundancy. The AC output neutral wire will not be connected to the chassis for either the F option or R option.

Example: MAC-4000-1U-4TL2G6S-E00, MAC-4000-1U-1TW1R5S-E00

VPX

Power Supplies



3U and 6U Military Power Supplies

The VPX power supplies are compliant with VITA 62, MIL-STD-704, MIL-STD-461 and MIL-STD-810 for 28 Vin DC, 270 Vin DC & Universal AC systems. The VPX delivers up to 1000 W and up to 6 outputs with a typical efficiency of 91%. Offered in VITA approved ruggedized 3U and 6U size packages with internal conduction cooling and high speed backplane connectors.

VPX Product Features

- VITA 62 and 47 Compliant
- Maximum Total Output Power: 1000 W
- Input EMI Filtering
- -40 °C to 85 °C Operating Temperature (at card edge)
- Active current share through backplane
- Over-current, over-voltage, over-temperature protection and Remote Sense
- Standard VITA 62 Controls
- Conformal Coating Option available
- Optional I2C Function
 - Supports IPMI/PMBus/VITA 46.11
 - Input Reverse Polarity Protection

Specification Compliance

VPX units are designed to meet:

- VITA 62
- VITA 47
- MIL-STD-810 - Environmental Engineering
- MIL-STD-461 - Electromagnetic Interference
- MIL-STD-704 - Aircraft Electrical Power
- MIL-STD-1275 - Vehicle Electrical Power – T version



Military VPX DC Power Supply

Series	Package Size (U)	Input Range	Mil Std Filtering	Output Voltage Combination Code	Packaging Options
VPX	3U 6U	DC28: 28 V	P: P - Passive filter T: T - Transient filter TH: TH - Transient filter with holdup	001 002 003 004	Y1: Screening S: S-Grade (MCOTS) M: M-Grade (MCOTS)
		DC48: 48 V			Y2: Conformal Coating N: No Conformal Coating C: Conformal Coating
		DC270: 270 V			Y3: I ² C Function []: No I ² C 2: I ² C

Example: VPX-3U-DC28P-001-MC2 For valid part numbers, refer to the website or contact your local sales representative.

Military VPX AC Power Supply

Series	Package Size (U)	Input Range	Number of Phases	Mil Std Filtering	Output Voltage Combination Code	Packaging Options
VPX	3U 6U	ACUNV: AC Universal Input	1: Single Phase 3: 3-Phase	C: Clamped Passive Filter CH: Clamped Passive Filter with Hold-up	001 N01	Y1: Screening S: S-Grade (MCOTS) M: M-Grade (MCOTS)
		AC115: 100-140 Vrms _{L-N}				Y2: Conformal Coating N: No Conformal Coating C: Conformal Coating
						Y3: I ² C Function []: No I ² C 2: I ² C

Example: VPX-3U-ACUNV-1-C-001-SN For valid part numbers, refer to the website or contact your local sales representative.



Model 28 Vin Transient Suppression EMI filtering	Total Output Power	Typical Outputs				Weight
		VS1	VS2	VS3	AUX	
VPX-6U-DC28T-001	800 W	+12 V @ 67 A		+5.0 V @ 30 A	+3.3 VAUX @ 15 A, +12 VAUX @ 1 A, -12 VAUX @ 1 A	3.8 lb
VPX-3U-DC28TH-001	500 W	+12 V @ 40 A	+3.3 V @ 20 A	+5.0 V @ 40 A	+3.3 VAUX @ 6 A, +12 VAUX @ 1 A, -12 VAUX @ 1 A	2.4 lb

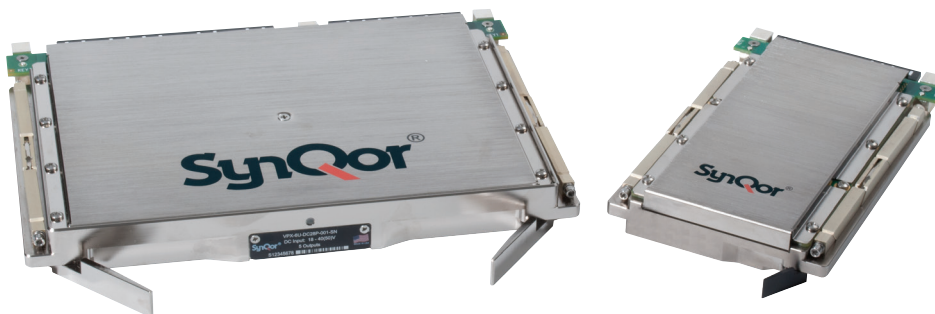

Model 28 Vin Passive EMI filtering	Total Output Power	Typical Outputs				Weight
		VS1	VS2	VS3	AUX	
VPX-6U-DC28P-001	1000 W	+12 V @ 80 A		+5.0 V @ 30 A	+3.3 VAUX @ 15 A, +12 VAUX @ 1 A, -12 VAUX @ 1 A	3.6 lb
VPX-3U-DC28P-001	500 W	+12 V @ 40 A	+3.3 V @ 20 A	+5.0 V @ 30 A	+3.3 VAUX @ 6 A, +12 VAUX @ 1 A, -12 VAUX @ 1 A	1.6 lb
VPX-3U-DC28P-002	500 W	+12 V @ 40 A	+3.3 V @ 25 A	+5.0 V @ 30 A	+3.3 VAUX @ 6 A, +12 VAUX @ 1 A, -12 VAUX @ 1 A	1.6 lb
VPX-3U-DC28P-003	500 W	+12 V @ 40 A	+3.45 V @ 20 A	+5.2 V @ 30 A	+3.3 VAUX @ 6 A, +12 VAUX @ 1 A, -12 VAUX @ 1 A	1.6 lb
VPX-3U-DC28P-004	500 W	+12 V @ 40 A	+3.3 V @ 20 A	+5.0 V @ 40 A	+3.3 VAUX @ 6 A, +12 VAUX @ 1 A, -12 VAUX @ 1 A	1.6 lb



Model 34-75 Vin Passive EMI filtering	Total Output Power	Typical Outputs				Weight
		VS1	VS2	VS3	AUX	
VPX-3U-DC48P-001	600 W	+12 V @ 50 A	+3.3 V @ 20 A	+5.0 V @ 30 A	+3.3 VAUX @ 6 A, +12 VAUX @ 1 A, -12 VAUX @ 1 A	1.6 lb

Model 270 Vin Passive EMI filtering	Total Output Power	Typical Outputs				Weight
		VS1	VS2	VS3	AUX	
VPX-6U-DC270P-001	730 W	+12 V @ 50 A		+5.0 V @ 30 A	+3.3 VAUX @ 40 A, +12 VAUX @ 1 A, -12 VAUX @ 1 A	3.8 lb
VPX-3U-DC270P-001	400 W	+12 V @ 33 A	+3.3 V @ 20 A	+5.0 V @ 30 A	+3.3 VAUX @ 6 A, +12 VAUX @ 1 A, -12 VAUX @ 1 A	1.6 lb

Model 85-264 Vrms Passive EMI filtering	Total Output Power	Typical Outputs				Weight
		VS1	VS2	VS3	AUX	
VPX-6U-ACUNV-1-C-001	630 W	+12 V @ 52.5 A		+5.0 V @ 40 A	+3.3 VAUX @ 20 A, +12 VAUX @ 1 A, -12 VAUX @ 1 A	3.6 lb
VPX-3U-ACUNV-1-C-N01	300 W	+12 V @ 25 A	+3.3 V @ 20 A	+5.0 V @ 30 A	+3.3 VAUX @ 6 A, +12 VAUX @ 1 A, -12 VAUX @ 1 A	1.7 lb
VPX-3U-ACUNV-1-C-001	300 W	+12 V @ 25 A	+3.3 V @ 20 A	+5.0 V @ 30 A	+3.3 VAUX @ 6 A, +12 VAUX @ 1 A, -12 VAUX @ 1 A	1.7 lb
VPX-3U-ACUNV-1-CH-001	300 W	+12 V @ 25 A	+3.3 V @ 20 A	+5.0 V @ 30 A	+3.3 VAUX @ 6 A, +12 VAUX @ 1 A, -12 VAUX @ 1 A	2.0 lb

Model 100-140 Vrms Passive EMI filtering	Total Output Power	Outputs		Weight	
		VS1	AUX		
VPX-3U-AC115-3-C-001	750 W	28V @ 27 A		+3.3 VAUX @ 150 mA	1.70 lb

VPX 3U and 6U Military Power Supplies

Control Features

ENABLE*	Standard VITA 62 control signal, enables +3.3 V_AUX.
INHIBIT*	Standard VITA 62 control signal, disables all outputs other than +3.3 V_AUX.
FAIL*	FAIL* Output indicates if one of the outputs is outside the specified voltage range.
SYSRESET*	SYSRESET* Output indicates startup is completed and power outputs are ready.

Parallel Operation

+12 V_MAIN, +3.3 V_MAIN, +5 V_MAIN	All main outputs include active sharing. On the 28 V input VPX modules, sharing on the +12 V_MAIN requires that VPX cards operate from the same input source and sharing does not provide glitch-free redundancy.
+3.3 V_AUX	Active current sharing is implemented on the 6U 270 V and AC input VPX modules. On the 3U/6U 28 V input, 3U AC input & 3U 270 V modules, active sharing on +3.3 V_AUX is not provided, but an OR'ing MOSFET is implemented and modules can be paralleled.
+12 V_AUX, -12 V_AUX	Active current sharing is not supported on these two auxiliary outputs. However, both outputs have OR'ing MOSFETs or OR'ing diodes implemented, so that they can be operated in parallel.

For more information see the datasheets on our website.

VPX-3U-ACUNV-1-N01 module does not support parallel operation.

Mil-COTS Converter and Filter Screening

Screening	Process Description	S-Grade	M-Grade
Baseplate Operating Temperature		-55 °C to +100 °C	-55 °C to +100 °C
Storage Temperature		-65 °C to +135 °C	-65 °C to +135 °C
Pre-Cap Inspection	IPC-A-610, Class III	Yes	Yes
Temperature Cycling	MIL-STD-883F, Method 1010, Condition B, 10 Cycles		Yes
Burn-In	100 °C Baseplate	12 Hours	96 Hours
Final Electrical Test	100%	25 °C	-55 °C, +25 °C, +100 °C
Final Visual Inspection	MIL-STD-883F, Method 2009	Yes	Yes

VITA 62 Control States

ENABLE*	INHIBIT*	+3.3 V_AUX	VS1, VS2, VS3, +12 V_AUX, -12 V_AUX
HIGH	HIGH	OFF	OFF
LOW	HIGH	ON	ON
HIGH	LOW	OFF	OFF
LOW	LOW	ON	OFF

VPX Module Qualification (VITA 47 Compliant)

Test Name	Method
Random Vibration	MIL-STD-810, 514.6 - Procedure I, Class V3
Shock	MIL-STD-810, 516.6 - Procedure I, VI, Class OS2
Altitude	MIL-STD-810, 500.5 - Procedure I, II, III
Fungus Resistance	MIL-STD-810, 508.6
Corrosion Resistance	ASTM G85, Annex A4
Humidity	MIL-STD-810, 507.5 - Procedure II
High Temperature	MIL-STD-810, 501.5 - Procedure I, II
Low Temperature	MIL-STD-810, 502.5 - Procedure I, II
Temperature Cycling	MIL-STD-202, 107 - Class C4
ESD	EN61000-4-2, Level 4; 15 kV Air Discharge



3U & 6U VPX AC-DC & DC-DC Power Supply Mechanicals

VPX 6U Mechanical

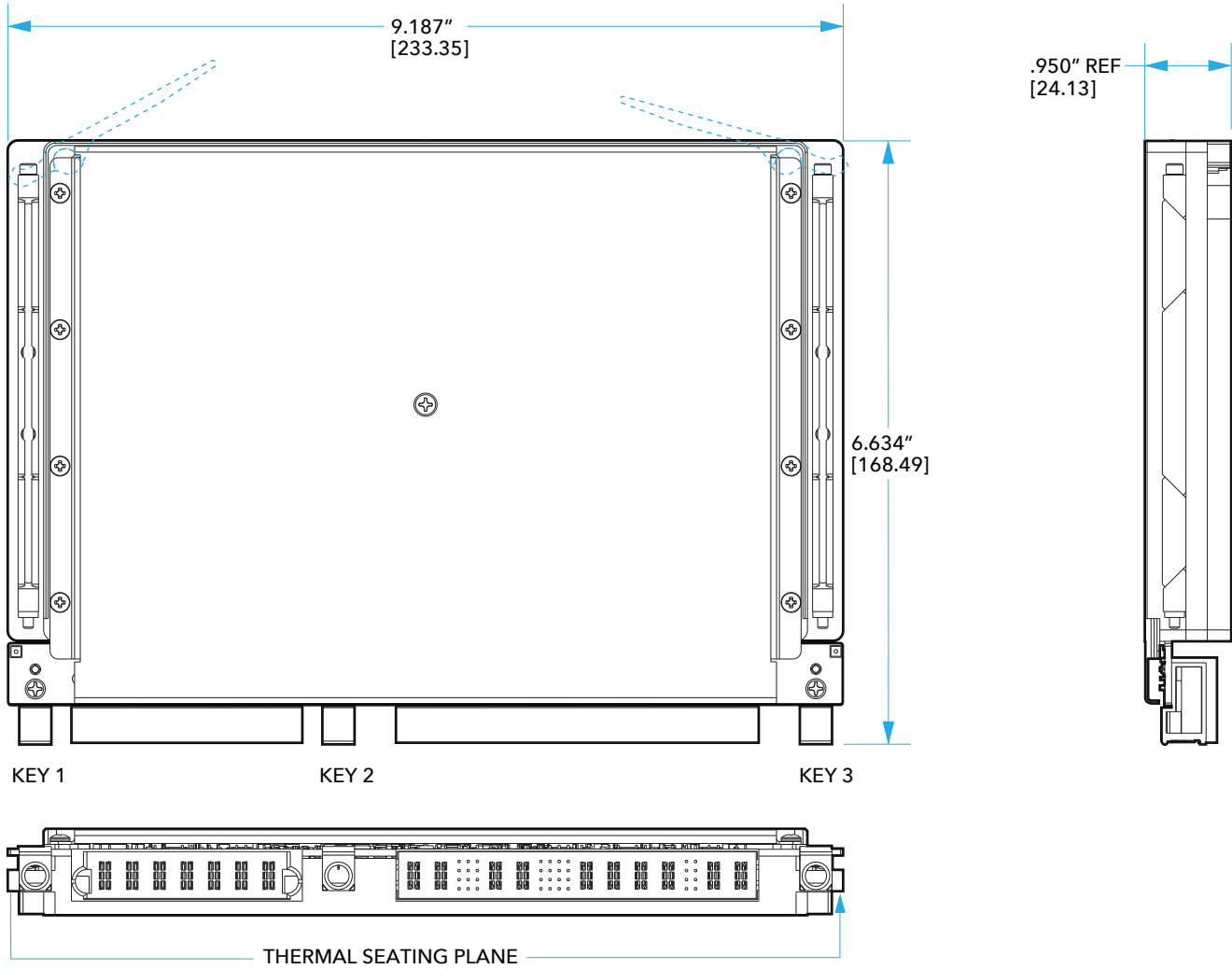

VPX 3U Mechanicals

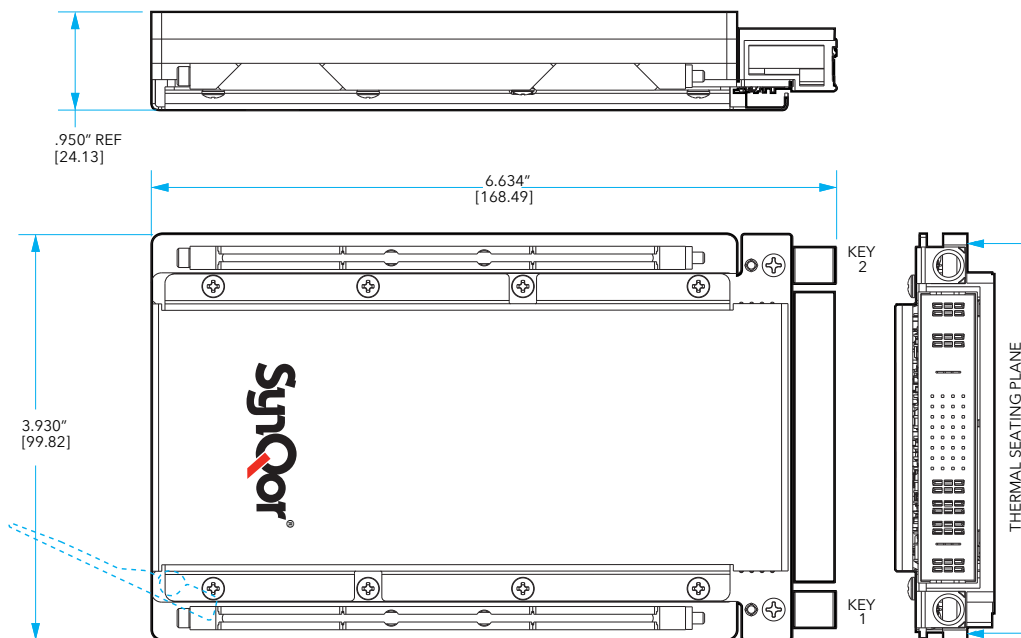

For more information see the datasheets on our website.

VPX 3U AC 3-Phase Input Mechanical

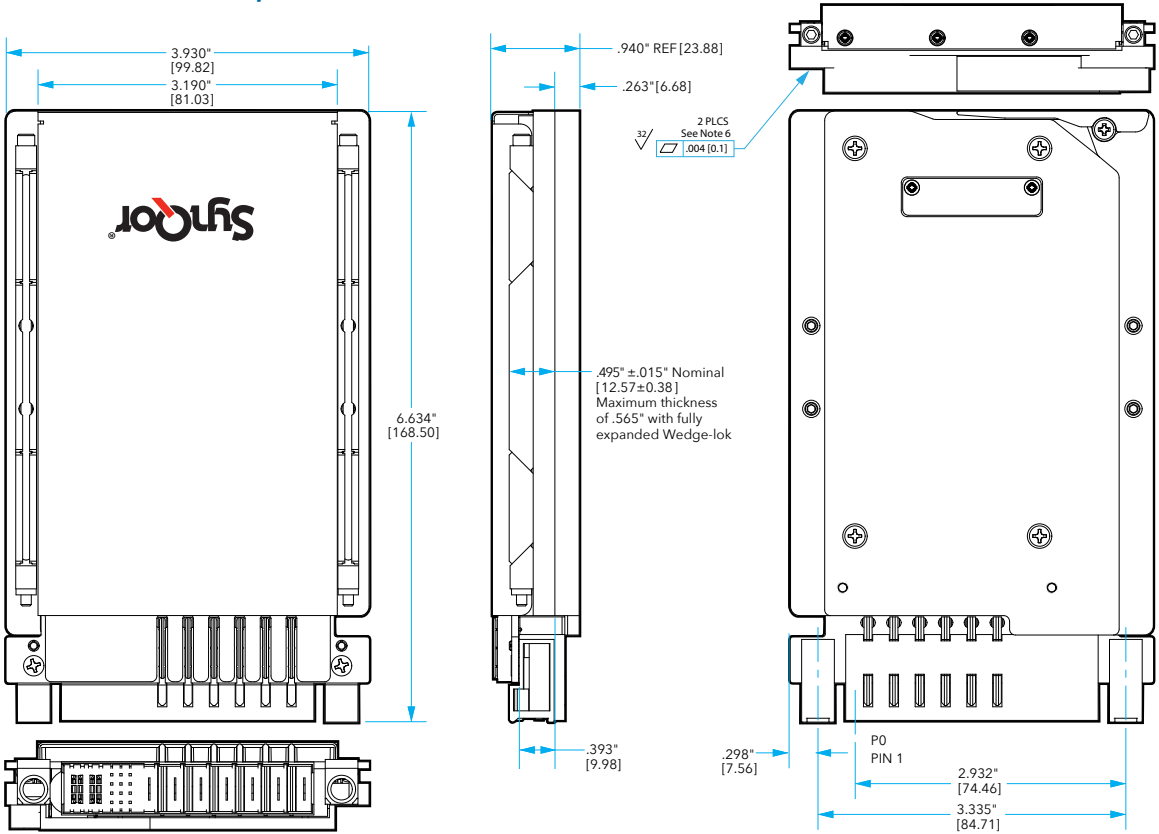

VPX 3U DC with Hold-Up Mechanical

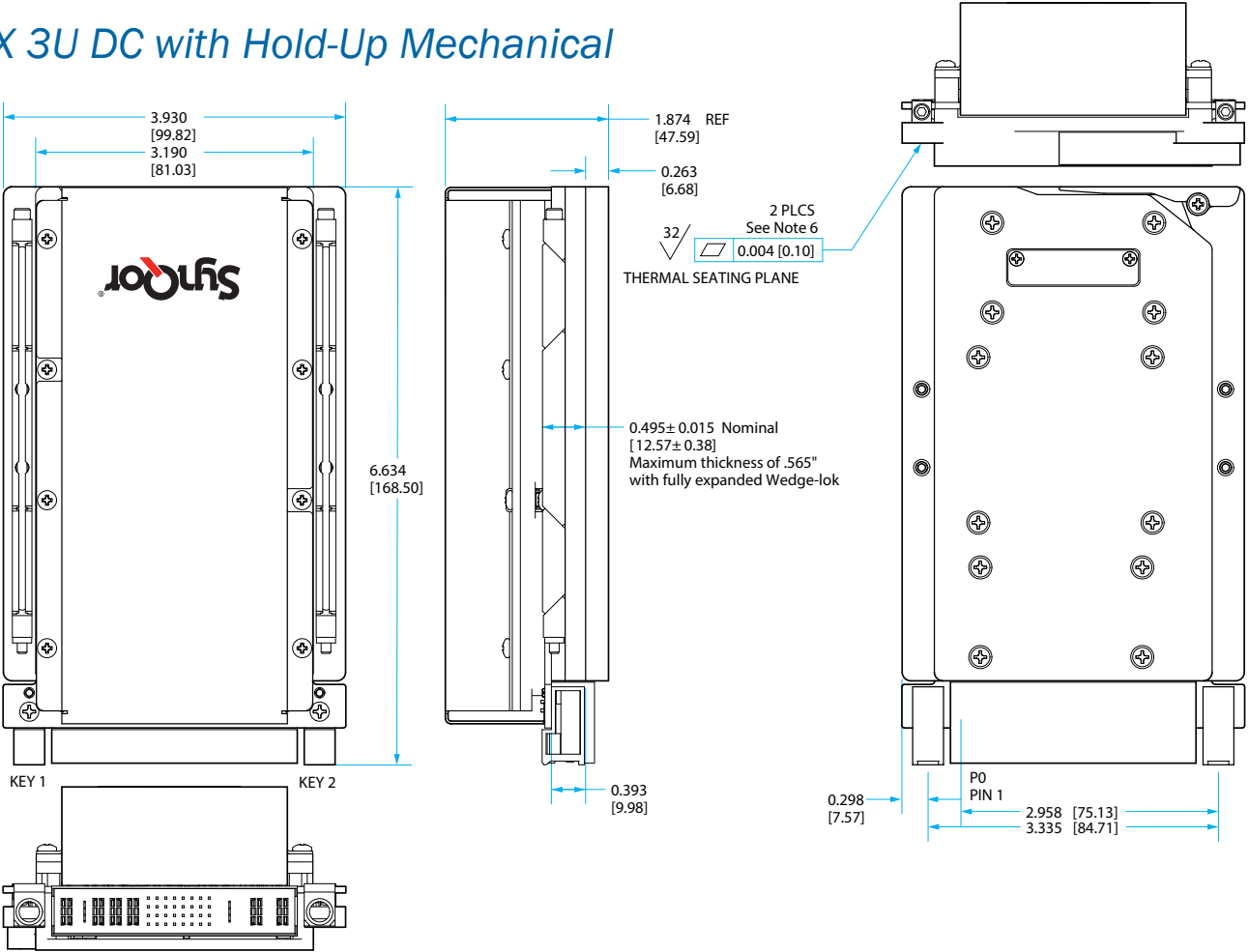



MultiQor™

Configurable DC-DC Power Supplies

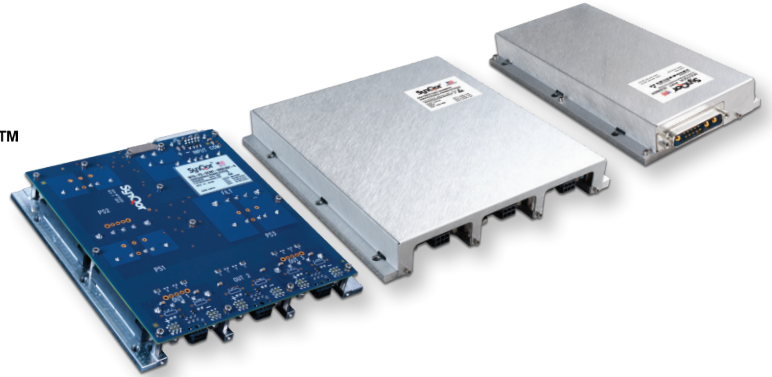

MultiQor Configurable Multi-Output Military DC-DC Power Supplies with EMI filter

The MultiQor Plate format of input-filtered DC-DC power supplies provides up to FOUR customer defined output voltages that are isolated from the input, each other and the cold plate. Using SynQor's Mil-COTS line of high efficiency, high reliability, fixed switching frequency DC-DC converters and EMI filters, this supply is designed to comply with MIL-STD-704, MIL-STD-1275, DEF-STAN 61-5 and MIL-STD-461 for a 28 Vin system when continuous full power operation is only needed down to 18 Vin. The complete assembly is designed to withstand the harsh conditions of Military and Aerospace applications and is compliant with MIL-STD-810 requirements.

Operational Features

- Internal EMI filter with ceramic stabilizing bulk cap
- Over-voltage Spike and Surge suppression circuitry to comply with: MIL-STD-704, MIL-STD-1275, DEF-STAN 61-5 (Part 6)/(5 or 6)
- Reverse polarity protection
- High efficiency converters (90%-95%)
- Fixed frequency switching provides predictable EMI
- No minimum load requirement
- Soft start of all outputs

Optional Features

- Remote Sense Jumpers
- Internal input fuse
- Output current sharing
- Cover

Control Features

- System Off control (isolated)
- Individual output voltage Inhibit control (isolated)
- Remote Sense for each output voltage
- Output voltage trim for each output
- Input Good signal (isolated)

Protection Features

- Input under-voltage lockout
- Output current limit and short circuit protection
- Output over-voltage protection
- Thermal shutdown
- Automatic restart for all of the above
- Active back bias current limit

MultiQor Configurable DC-DC Power Supplies

Family	Plate Format (# of Outputs)	MIL-STD Compliance	8 Digit Application Identification Number	Screening	Optional Character
MTQ	P1: 1 output P2: 2 outputs P3: 3 outputs P4: 4 outputs	DC28T: MIL-STD-704 MIL-STD-1275 DEF-STAN 61-5 (Part 6)/6 (converters shut off below 16 Vin)	8 Digit Application Identification Number	S: S-Grade M: M-Grade	Blank: Standard V: Cover

Example: MTQ-P3-DC28T-XXXXXXXX-SV For valid part numbers, refer to the website or contact your local sales representative.

Model Number	Total Output Power	Configuration	Package Size	Weight
MTQ-Px-DC28T (18 V-40 Vin with Transient Suppression EMI input filter)	450 W	Up to 4 customer defined outputs	P1/P2: 3.80" x 6.84" x 0.92" P3/P4: 6.70" x 6.84" x 0.92"	1.0 lb - 1.4 lb* 2.1 lb - 2.5 lb*

* Weights vary depending on converters

DC28T Configurations

P1

SINGLE OUTPUT

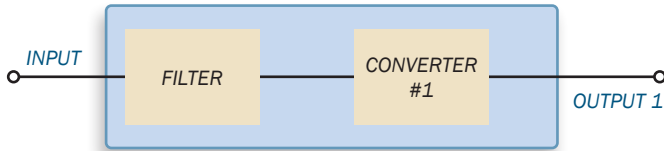

P1 DC-DC CONVERTER OPTIONS:

- Any Quarter-Brick or Half-Brick converter from the MCOTS-28 Family
- Size: 3.80" x 6.84" x 0.92"
- Typical Weight: 1.0 LB to 1.3 LBS (1QB or 1 HB)

P2

DUAL OUTPUT

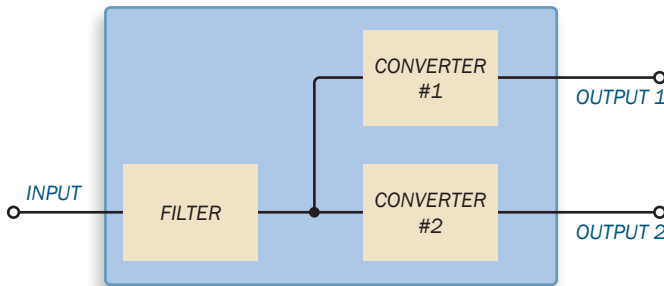

P2 DC-DC CONVERTER OPTIONS:

- Any Quarter-Brick converter from the MCOTS-28 Family
- Size: 3.80" x 6.84" x 0.92"
- Typical Weight: 1.4 LBS (2QB)

P3

TRIPLE OUTPUT

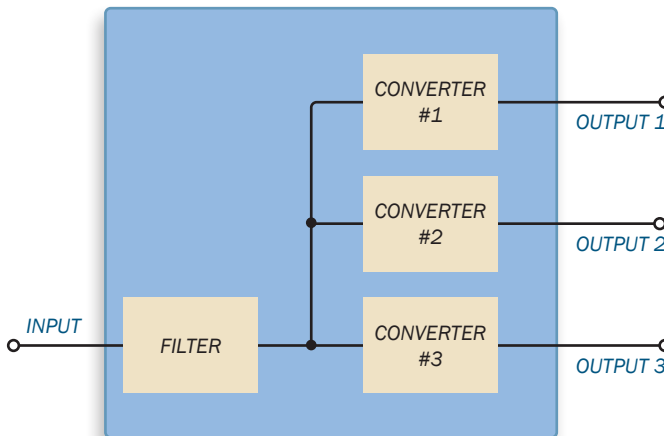

P3 DC-DC CONVERTER OPTIONS:

- Any Quarter-Brick or Half-Brick converter from the MCOTS-28 Family
- Size: 6.70" x 6.84" x 0.92"
- Typical Weight: 2.1 LBS to 2.5 LBS (3QB or 3 HB)

P4

QUAD OUTPUT

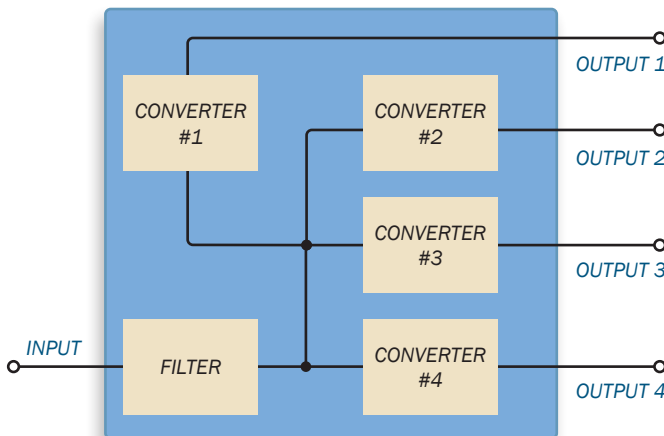

P4 DC-DC CONVERTER OPTIONS:

- Converter #1: Half-brick converter from the MCOTS-28 Family
- Converters #2, #3, #4: Any Quarter-Brick converter from the MCOTS-28 Family
- Size: 6.70" x 6.84" x 0.92"
- Typical Weight: 2.4 LBS (3QB and 1HB)

MultiQor™

Configurable DC-DC Power Supplies



MultiQor Configurable Single-Output, Increased Power Military DC-DC Power Supplies

The MultiQor Plate format of Military Field-Grade DC-DC power supplies provides one customer defined output voltage that is isolated from the input and the cold plate. Using SynQor's Mil-COTS line of high efficiency, high reliability, fixed switching frequency DC-DC converters, this supply is designed to comply with MIL-STD-704 for a 28 Vin system when continuous full power operation is only needed down to 16 Vin. The complete assembly is designed to withstand the harsh environments of the Military and Aerospace industries and is compliant with MIL-STD-810 requirements.

Operational Features

- Designed to comply with MIL-STD-704 Steady State
- High efficiency converters (90%-95%)
- Fixed frequency switching provides predictable EMI
- No minimum load requirement
- Soft start of all outputs

Control Features

- System On/Off control (isolated)
- Output voltage Inhibit control (isolated)
- Remote Sense for the output voltage
- Output voltage trim (-20%, +10%) available
- Input Good signal (isolated)

Optional Features

- Remote Sense Jumpers
- Internal input fuse
- Output current sharing
- Cover

Protection Features

- Input under-voltage lockout
- Output current limit and short circuit protection
- Output over-voltage protection
- Thermal shutdown
- Automatic restart for all of the above
- Active back bias current limit

MultiQor Configurable DC-DC Power Supplies

Family	Plate Format (# of Converters)	MIL-STD Compliance	8 Digit Application Identification Number	Screening	Optional Character
MTQ	P1: 1 converters P2: 2 converters P3: 3 converters	DC28: N/A	8 Digit Application Identification Number	S: S-Grade M: M-Grade	Blank: Standard V: Cover

Example: MTQ-P3-DC28-XXXXXXXX-SV For valid part numbers, refer to the website or contact your local sales representative.

Model Number	Total Output Power	Configuration	Package Size	Weight
MTQ-Px-DC28 (16 V-40 Vin with no input filter)	1500 W	One customer defined output (with up to 3 converters in parallel)	P1/P2: 3.80" x 6.84" x 0.92"	1.3 lb - 1.6 lb*
			P3: 6.70" x 6.84" x 0.92"	2.5 lb

* Weights vary depending on converters

DC28 Configurations

P1 SINGLE CONVERTER, SINGLE OUTPUT

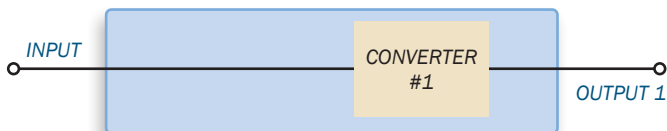

P1 DC-DC CONVERTER OPTIONS:

- Any Half-Brick Zeta converter from the MCOTS-28 Family
- Size: 3.80" x 6.84" x 0.92"
- Typical Weight: 1.3 LBS (1 HB)

P2 DUAL CONVERTER, SINGLE OUTPUT

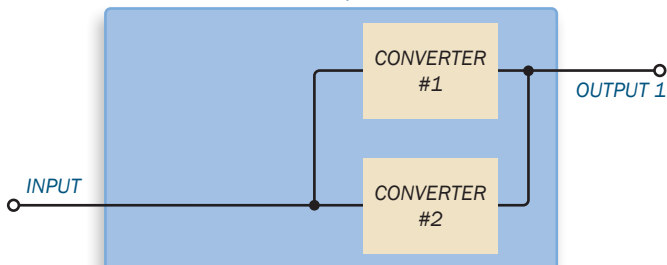

P2 DC-DC CONVERTER OPTIONS:

- Any Half-Brick Zeta converter from the MCOTS-28 Family
- Size: 3.80" x 6.84" x 0.92"
- Typical Weight: 1.6 LBS (2HB)

P3 TRIPLE CONVERTER, SINGLE OUTPUT

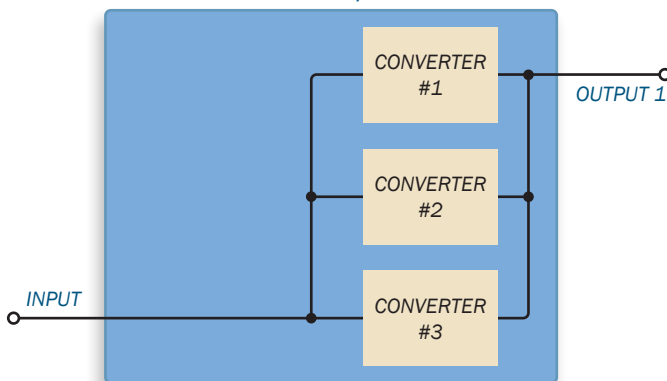

P3 DC-DC CONVERTER OPTIONS:

- Any Half-Brick Zeta converter from the MCOTS-28 Family
- Size: 6.70" x 6.84" x 0.92"
- Typical Weight: 2.5 LBS (3 HB)

DC28 & DC28T

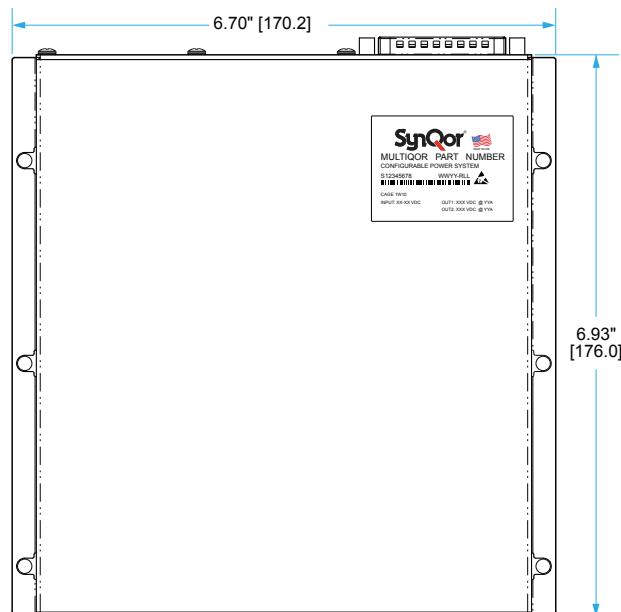
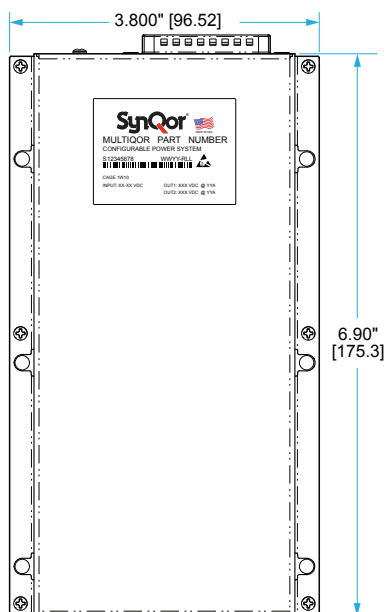

P1 AND P2 HAVE SIMILAR COVERS

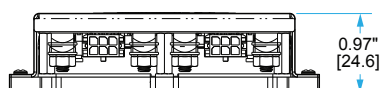

P3 AND P4 HAVE SIMILAR COVERS

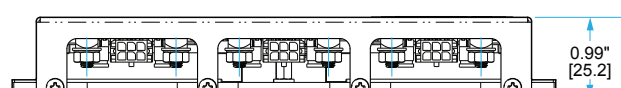

MultiQor™

Configurable AC-DC Power Supplies



MultiQor Configurable Multi-Output Military AC-DC Power Supplies

The MultiQor Plate format of input-filtered single phase AC-DC power supplies provides up to two customer defined output voltages that are isolated from the input, each other and the cold plate. Using SynQor's Mil-COTS line of high efficiency, high reliability, fixed switching frequency DC-DC converters, PFC and EMI filters, this supply is designed to comply with MILSTD-704, and MIL-STD-1399. The complete assembly is designed to withstand the harsh environments of the Military and Aerospace industries and is compliant with MIL-STD-810 requirements.

Operational Features

- Input voltage range: 85 - 180 Vrms (AC115)
85 - 264 Vrms (ACUNV)
- Universal input frequency range:
47 - 63 Hz / 360 - 800 Hz
- Up to 650 W output power
- ≥ 0.99 Power Factor (50 / 60 Hz)
- Internal inrush current limit
- Hold-Up Capacitors
(with available external connection)

Compliance Features

MultiQor units are designed to meet:

- MIL-STD-704 - Aircraft Electrical Power
- MIL-STD-1399-300 - Interface Shipboard

MultiQor Configurable AC-DC Power Supplies

Family	Plate Format (# of Outputs)	Input Voltage Range	Phase	6 Digit Application Identification Number	Screening	Housing
MTQ	P1: 1 output P2: 2 outputs	AC115: 85-180 Vrms ACUNV: 85-264 Vrms	1: Single Phase	6 Digit Application Identification Number	S: S-Grade M: M-Grade	V: Cover

Example: MTQ-P1-AC115-1-XXXXX-SV For valid part numbers, refer to the website or contact your local sales representative.

Model Number	Total Output Power	Configuration	Package Size	Weight
MTQ-Px-AC115 (85-180 Vrms with input filter)	650 W	Up to 2 customer defined outputs	P1/P2: 6.70" x 9.12" x 1.23"	3.4 to 3.7 lbs*
MTQ-Px-ACUNV (85-264 Vrms with input filter)	650 W	Up to 2 customer defined outputs	P1/P2: 6.70" x 9.12" x 1.23"	3.4 to 3.7 lbs*

* Weights vary depending on converters

AC115 & ACUNV Configurations

P1 SINGLE OUTPUT

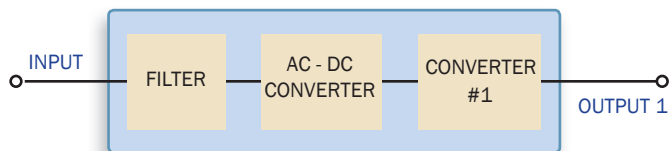

P1 CONVERTER OPTIONS:

- Any Full-Brick or Half-Brick converters from the MCOTS-270 Family
- Size: 6.70" x 9.12" x 1.23"
- Typical Weight: 3.4 LB to 3.7 LBS (1 HB or 1 FB)

P2 DUAL OUTPUT

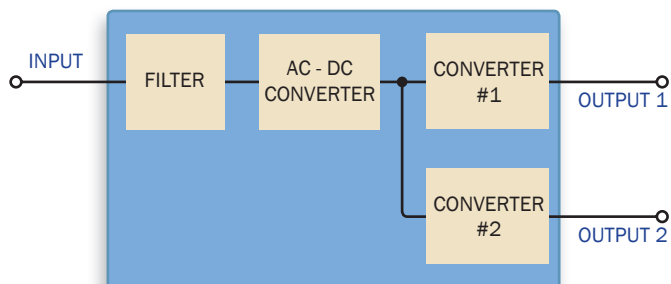

P2 CONVERTER OPTIONS:

- Any two Half-Brick converters from the MCOTS-270 Family
- Size: 6.70" x 9.12" x 1.23"
- Typical Weight: 3.7 LBS (2 HB)

MULTI-OUTPUT AC115 / ACUNV – P1 AND P2 HAVE SIMILAR COVERS

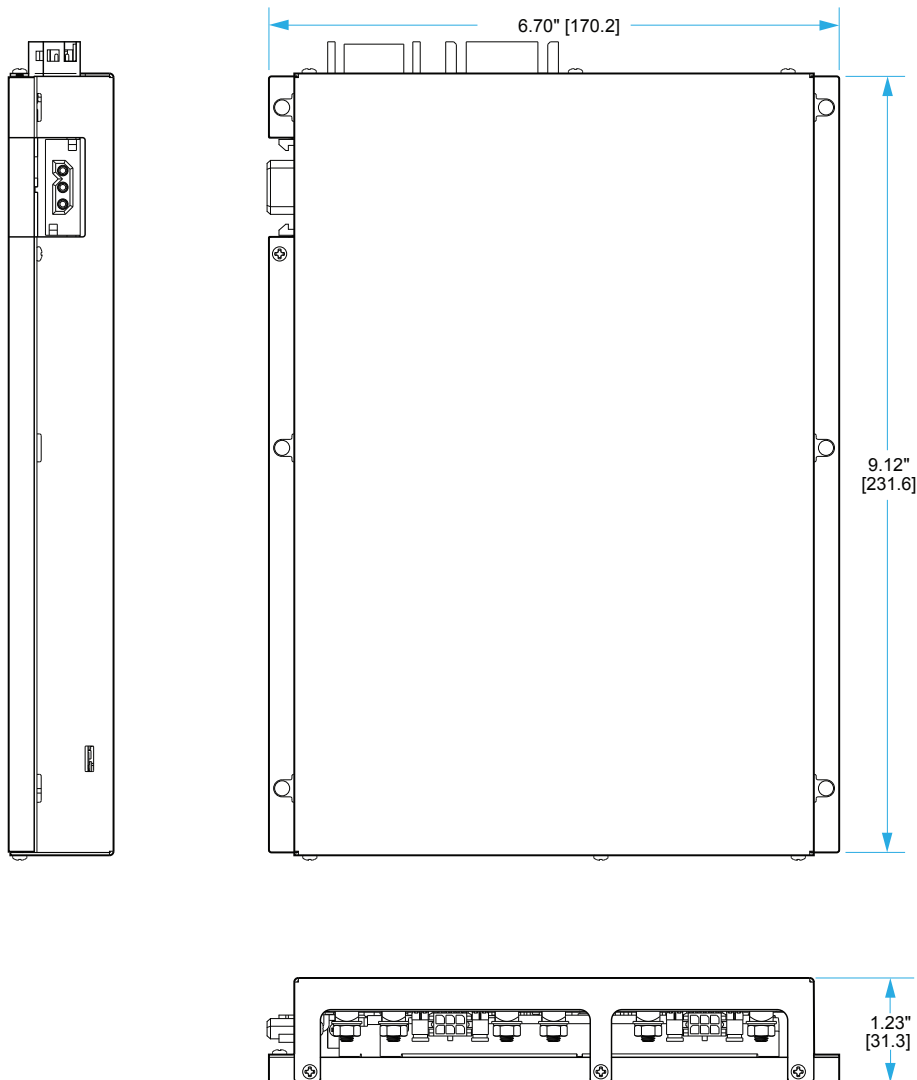



Isolated Power Factor Correction Module for the Avionics Industry

The AeroQor® Isolated PFC Module is a high efficiency, active PFC, AC-DC converter designed to be used as a COTS Component in airborne applications. It operates from a universal AC input and generates an isolated DC output. Regulated output and droop output modules are available. Used in conjunction with a hold-up capacitor, and SynQor's AC line filter, the AeroQor module will draw a nearly perfect sinusoidal current (PF>0.99) from a single phase AC input. The module is designed with a high level of documentation and traceability.

Operational Features

- Isolated output, 100 W, 325 W, 600 W & 800 W output power
- Universal input frequency range: 47 - 63 Hz / 360 - 800 Hz
- Input voltage range: 85-264 Vrms
- ≥0.99 Power Factor
- High efficiency: 92% (230 Vrms)
- -40 °C to +100 °C Operating Temperature
- Internal inrush current limit. Full-brick model has enhanced control that keeps inrush current to nearly zero.
- Auxiliary bias supply
- Can be paralleled (droop version only)
- Compatible with SynQor's AeroQor AC line filters
- Hold-up available on 600 W FG model only

Protection/Control Features

- PFC Enable
- AC and DC Power Good outputs
- Input current limit and auto-recovery short circuit protection
- Auto-recovery input under / over-voltage protection
- Auto-recovery output over-voltage protection
- Auto-recovery thermal shutdown

Specification Compliance

- RTCA/DO-160
- Airbus ABD0100.1.8
- Boeing 787B3-0147
- Boeing D6-36440
- Boeing D6-44588
- CE marked

AeroQor Isolated Power Factor Correction Module

Family	Input Voltage	Output Voltage	Regulation	Package Size	Thermal Design	RoHS
APFIC	U: 85-264 V	12: 12 V 24: 24 V 28: 28 V 48: 48 V 55: 55 V	R: Regulated Output D: Droop Sharing	HM: Half-brick Mega HT: Half-brick Tera FT: Full-brick Tera	C: Encased D: Encased with Non-threaded Baseplate V: Encased with Flanged Baseplate	G: RoHS

Example: APFIC-U-24D-HT-C-G

Family	Input Voltage	Output Voltage	Regulation	Package Size	Thermal Design	RoHS
APFIC	U: 85-264 V	12: 12 V 24: 24 V 28: 28 V 48: 48 V 55: 55 V	RH: Regulated Output with Hold-up DH: Droop Sharing with Hold-up	FG: Full-brick Giga	C: Encased D: Encased with Non-threaded Baseplate V: Encased with Flanged Baseplate	G: RoHS



AC Line Filter Modules for the Avionics Industry

The AeroQor® EMI AC Line Filters brings SynQor’s field proven technology and manufacturing expertise to the Avionics COTS Component marketplace. SynQor’s innovative packaging approach ensures survivability in the most hostile environments. Compatible with the industry standard format, these filters have high differential-mode and common-mode attenuation and low series resistance. They follow conservative component derating guidelines and they are designed and manufactured to the highest standards.

Filter Features

- 85 to 264 Vrms
- Very low series resistance
- High Differential & Common-mode Attenuation
- All capacitors are safety-rated X7R multi-layer ceramic
- Meets common EMC standards in properly designed system with SynQor APFIC modules.
- -40 °C to +100 °C Operating Temperature
- Low power dissipation

Specification Compliance

- RTCA/DO-160
- Airbus ABD0100.1.8
- Boeing 787B3-0147
- Boeing D6-36440
- Boeing D6-44588
- CE marked

AeroQor AC Line Filter

Family	Input Frequency	Input Voltage	Package Size	Thermal Design	RoHS
ACF	U: 45 - 800 Hz	230: 85 to 264 Vrms	QT: Quarter-brick Tera QM: Quarter-brick Mega HT: Half-brick Tera HP: Half-brick Peta	C: Encased V: Encased with Flanged Baseplate	G: RoHS

Example: ACF-U-230-ET-C-G For valid part numbers, refer to the website or contact your local sales representative.

Model Number	Input Frequency	Input Voltage (L-N)	Output Current	Output Power	Max Series Resistance	Differential & Common-mode Attenuation
ACF-U-230-QT	45-800 Hz	85-264 Vrms	5 Arms	575 W@ 115 Vrms 1.5 kW@ 230 Vrms	330 mΩ @ 100 °C	>40 dB @ 250 kHz
ACF-U-230-QM	45-800 Hz	85-264 Vrms	2 Arms	230 W@ 115 Vrms 460 W@ 230 Vrms	900 mΩ @ 100 °C	>45 dB @ 250 kHz
ACF-U-230-HT	45-800 Hz	85-264 Vrms	9 Arms	1 kW@ 115 Vrms 2 kW@ 230 Vrms	195 mΩ @ 100 °C	>30 dB @ 200 kHz
ACF-U-230-HP	45-800 Hz	85-264 Vrms	11.5 Arms	1 kW@ 115 Vrms 2 kW@ 230 Vrms	195 mΩ @ 100 °C	>30 dB @ 200 kHz

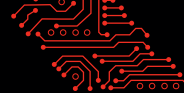

3-Phase Isolated Power Factor Correction Module for the Avionics Industry

The AeroQor® Isolated PFC Module is a high efficiency, active PFC, AC-DC converter designed to be used as a COTS Component in airborne applications. It operates from a 115 Vrms AC input and generates an isolated DC output. Regulated output and droop output modules are available. Used in conjunction with a holdup capacitor, and SynQor's AC line filter, the AeroQor module will draw a nearly perfect sinusoidal current (PF>0.99) from a 3-Phase AC input. The module is supplied completely encased to provide protection from the harsh environments seen in many industrial areas.

Operational Features

- Compatible with commercial aircraft 60 Hz, 400 Hz and variable frequency systems
- Harmonic content meets commercial aircraft standards
- Minimal inrush current
- Balanced phase currents
- High power factor (0.99 at 400 Hz / 750 W)
- Minimal external output capacitance requirement
- Full load current during startup
- Ability to meet full EMI with available additional EMI filters
- N * 750 W power levels when paralleled
- 100 °C max baseplate temperature at full power
- -40 °C to +100 °C Operating Temperature

Protection/Control Features

- All control pins referenced to separate floating return
- Asynchronous serial data interface
- AC and DC Power Good outputs
- PFC Enable input
- 3.3 V always-on standby power output
- Clock synchronization output
- Output current limit and auto-recovery short circuit protection
- Auto-recovery input under / over-voltage protection
- Auto-recovery output over-voltage protection
- Auto-recovery thermal shutdown

Specification Compliance

- RTCA/DO-160
- Airbus ABD0100.1.8
- Boeing 787B3-0147
- Boeing D6-36440
- Boeing D6-44588
- CE marked

AeroQor 3-Phase Isolated Power Factor Correction Module

Family	Vin Range	Input Phases	Vout	Regulation	Package Size	Thermal Design	RoHS
APFIC	115: 115 Vrms	3PH: 3-Phase	12: 12 V 24: 24 V 28: 28 V 48: 48 V 54: 54 V	R: Regulated Output D: Droop Sharing	FT: Full-brick Tera	C: Encased D: Encased with Non-threaded Baseplate V: Encased with Flanged Baseplate	G: RoHS

Example: APFIC-115-3PH-28R-FT-C-G For valid part numbers, refer to the website or contact your local sales representative.



3-Phase AC Line Filter Modules for the Avionics Industry

The AeroQor® EMI AC Line Filters brings SynQor’s field proven technology and manufacturing expertise to the Avionics COTS Component marketplace. SynQor’s innovative packaging approach ensures survivability in the most hostile environments. Compatible with the industry standard format, these filters have high differential-mode and common-mode attenuation and low series resistance. They follow conservative component derating guidelines and they are designed and manufactured to the highest standards.

Filter Features

- 85 to 264 Vrms
- Very low series resistance
- High Differential & Common-mode Attenuation
- All capacitors are safety-rated X7R multi-layer ceramic
- Meets common EMC standards in properly designed system with SynQor APFIC modules.
- -40 °C to +100 °C Operating Temperature
- Low power dissipation

Specification Compliance

- RTCA/DO-160
- Airbus ABD0100.1.8
- Boeing 787B3-0147
- Boeing D6-36440
- Boeing D6-44588
- CE marked

AeroQor 3-Phase AC Line Filter

Family	Input Frequency	Input Voltage	Phase	Package Size	Thermal Design	RoHS
ACF	U: 45 - 800 Hz	115: 85 to 264 Vrms	3PH: 3-Phase	QG: Quarter-brick Giga	C: Encased V: Encased with Flanged Baseplate	G: RoHS

Example: ACF-U-115-3PH-QG-C-G For valid part numbers, refer to the website or contact your local sales representative.

Model Number	Input Frequency	Input Voltage (L-N)	Output Current	Output Power	Max Series Resistance	Differential-mode & Common-mode Attenuation
ACF-U-115-3PH-QG-x-G	45-800 Hz	85-140 Vrms	3 Arms	1 kW @ 115 Vrms	700 mΩ @ 100 °C	>55 dB @ 200 kHz >40 dB @ 200 kHz



Isolated DC-DC Converters for the Rail Transportation Industry

The RailQor® converter series is composed of next-generation, board-mountable, isolated, fixed switching frequency DC-DC converters that use synchronous rectification to achieve extremely high power conversion efficiency, even at low output power levels. The Quarter-brick 25 W-50 W Mega Series has power dissipation so low that no heatsink is necessary to operate at 85 °C in an enclosed environment without airflow. Each module is supplied completely encased to provide protection from the harsh environments seen in many industrial and transportation applications.

General Specifications

- Operating Temperature -40 °C to +100 °C
- Output Voltage Set Point $\pm 1.0\%$
- Output Voltage Ripple <1% of V_{out} (typ.) pk-pk
- Switching Frequency 240 - 350 kHz
- Output Voltage Trim Range +10% to -20%
- Input-to-Output Isolation Up to 2000 Vrms
- EN50155 Compliance
- RIA 12 Compliance with external circuit
- Industry standard pin-out configurations and standard footprints

Protection/Control Features

- Input under-voltage lockout
- Output current limit and short circuit protection
- Active back bias limit prevents damage to converter
- Output over-voltage protection
- Thermal shutdown

Operational Features

- High efficiency at full load up to 93%
- Quarter-brick 25-50 W Mega Series has no derating in environments with zero airflow and ambient temperatures up to 85 °C with no heatsink.
- Input voltage ranges: 9-36 V, 18-45 V, 18-75 V, 42-110 V, 12-155 V, 34-160 V and 66-160 V
- Input voltage ranges meet the requirements of EN 50155
- Full power operation at baseplate temperature range from -40 °C to 100 °C.
- Output power up to 500 W
- Fixed frequency switching, low output noise
- No minimum load requirement
- Encased module to provide protection from harsh environments and available with optional flanged style baseplate.
- Output Current Sharing (HE/HZ only)

See "Encased Package Configurations" on page 95 for package outlines.

Rail Transportation Isolated DC-DC Converters

RailQor Input/Output Ratings

Family	VOUT	3.3 V	5 V	12 V	15 V	24 V	48 V	56 V	Package Size / Power Level
2:1 Input Ratio		72 V (42 V - 110 V) Continuous Input Range, (150 V Transient, QT and HP only)							
RQ72	Max. Iout / Power Out		10 A / 50 W	4.1 A / 49 W	3.3 A / 50 W	2 A / 48 W			Quarter-brick / Mega
			25 A / 125 W	12 A / 144 W	10 A / 150 W	6 A / 144 W	3 A / 144 W		Quarter-brick / Tera
			46 A / 230 W	21 A / 252 W	17 A / 255 W	10.4 A / 250 W	5.2 A / 250 W		Half-brick / Peta
2:1 Input Ratio		110 V (66 V - 160 V) Continuous Input Range, 200 V Transient							
RQ1B	Max. Iout / Power Out	15 A / 50 W	10 A / 50 W	4.1 A / 49 W	3.3 A / 50 W	2 A / 48 W	1 A / 48 W		Quarter-brick / Mega
			20 A / 100 W	8.4 A / 101 W		4.2 A / 101 W	2.1 A / 101 W		Quarter-brick / Giga
		30 A / 99 W	25 A / 125 W	12 A / 144 W	10 A / 150 W	6 A / 144 W	3 A / 144 W	3 A / 168 W	Quarter-brick / Tera
			48 A / 240 W	21 A / 252 W	17 A / 255 W	10 A / 240 W	5.2 A / 250 W		Half-brick / Peta
			60 A / 300 W	27 A / 324 W	21.7 A / 325 W	13.6 A / 326 W	6.8 A / 326 W		Half-brick / Exa
			60 A / 300 W	42 A / 504 W	33 A / 495 W	21 A / 504 W	10 A / 480 W		Half-brick / Zeta
4:1 Input Ratio		18 V (9 V - 36 V) Continuous Input Range, 40 V Transient							
RQ18	Max. Iout / Power Out		10 A / 50 W	4.1 A / 49 W	3.3 A / 50 W	2 A / 48 W			Quarter-brick / Mega
			20 A / 100 W	8.0 A / 96 W	7.0 A / 105 W	4 A / 96 W	2 A / 96 W		Quarter-brick / Tera
			36 A / 180 W	15 A / 180 W	12 A / 180 W	7.5 A / 180 W	3.7 A / 178 W		Half-Brick / Peta
4:1 Input Ratio		36 V (18 V - 75 V) Continuous Input Range, 80 V Transient							
RQ36	Max.		10 A / 50 W	4.1 A / 49 W	3.3 A / 50 W	2 A / 48 W	1 A / 48 W		Quarter-brick / Mega
4:1 Input Ratio		90 V (34 V - 160 V) Continuous Input Range, 200 V Transient							
RQ90	Max. Iout / Power Out		10 A / 50 W	4.2 A / 50 W	3.3 A / 50 W	2.1 A / 50 W	1 A / 48 W		Quarter-brick / Mega
			24 A / 120 W	10 A / 120 W	8 A / 120 W	5 A / 120 W	2.5 A / 120 W		Quarter-brick / Tera
			40 A / 200 W	19 A / 228 W	15 A / 225 W	9.5 A / 228 W	4.6 A / 221 W		Half-brick / Peta
			13.8 Vout - 21.7 A / 300 W (40 V - 160 V Continuous, 200 V Transient)						
12:1 Input Ratio		68 V (12 V - 155 V) Continuous Input Range, 170 V Transient							
RQ68	Max. Iout / Power Out		5.3 A / 26 W	2.2 A / 27 W	1.8 A / 27 W	1.1 A / 26 W			Quarter-brick / Mega
			10.6 A / 53 W	4.4 A / 53 W	3.5 A / 53 W	2.2 A / 53 W			Half-brick / Giga
			20 A / 100 W	8.4 A / 101 W	6.7 A / 101 W	4.2 A / 101 W	2.1 A / 101 W		Half-brick / Exa
			30 A / 150 W	12.5 A / 150 W	10 A / 150 W	6 A / 144 W	3 A / 144 W		Half-Brick / Zeta

Family	Output Voltage	40 V	Package Size / Power Level
2:1 Input Ratio		24 V (18 V - 45 V) Continuous Input Range, 50 V Transient	
RQ24	Max. Iout / Power Out	12.5 A / 500 W	Half-brick Zeta

RailQor Part Numbering Guide

Family	Cont. Vin	Output Voltage	Package Size	Series	Thermal Design	Max. Output Current	Enable Logic	Pin Length	Features
RQ	18: 9 - 36 V 24: 18 - 45 V 36: 18 - 75 V 68: 12 - 155 V 72: 42 - 110 V 90: *34 - 160 V 1B: 66 - 160 V	033: 3.3 V 050: 5 V 120: 12 V 138: 13.8 V 150: 15 V 240: 24 V 480: 48 V 560: 56 V	Q: Quarter-brick H: Half-brick	G: Giga M: Mega P: Peta T: Tera E: Exa Z: Zeta	C: Encased D: Encased, Non-threaded Baseplate V: Encased, Flanged Baseplate	60: 60 A 48: 48 A 46: 46 A 36: 36 A 25: 25 A 21: 21 A 15: 15 A 12: 12 A 10: 10 A 08: 8 A 07: 7 A 06: 6 A 05: 5 A 04: 4 A 02: 2 A 01: 1 A	N: Negative	R: 0.180"	S: Standard F: Full Feature (HE/HZ only)

Example: RQ90050QMC10NRF-G For valid part numbers, refer to the website or contact your local sales representative or distributor. *RQ90138HEX22 Only Vin Range 40 - 160 V.

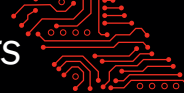

Technical Support

SynQor understands the need for rapid development of new projects in the transportation industry and provides excellent support for new designs incorporating the RailQor product lines. Concerns regarding EN 50155 compliance, transient and surge suppression to meet RIA 12, design for optimal thermal performance and other techniques are described in our RailQor datasheets and in technical papers available at www.synqor.com/support-technical-documents.html.

Application Notes

- **“RailQor EN 50155 / RIA-12 Compliance and Evaluation Board Application Note”** – Addresses the input voltage requirements of the European Railway Standards EN50155 and RIA-12 and how to meet them using SynQor’s RailQor DC-DC converters. The RailQor converters are designed to meet or exceed EN50155 input static and transient DC voltage requirements. Since some equipment is being designed to also comply with RIA-12 surges and transients, those requirements are discussed as well, along with the supplemental circuitry needed to meet those requirements.
- **“EMI Characteristics”**
 - On overview of EMI with suggestions for external filtering solutions and suggested layout and grounding practices.
- **“Input System Instability”**
 - Describes the phenomena of input instability in DC-DC converters and the preferred solution for correcting it.

Datasheet Application Information

- How to lay out a board for optimal thermal performance with RailQor product
- Circuits for driving the enable pin
- How to trim the converter to compensate for resistive drops between supply and load

RailQor Qualification Testing

Testing Type	Units	Test Conditions
Vibration	5	EN 61373:1999 Category I, Class B, Body mounted
Life Test	30	95% rated Vin and load, units at derating point, 1000 hours
Cold	5	EN 60068-2-1:2007
Dry Heat	5	EN 60068-2-2:2007
Mechanical Shock	5	EN 61373:1999 Category I, Class B, Body mounted
Temperature Cycling	5	-40 °C to 100 °C, unit temp. ramp 15 °C/min., 500 cycles
Power/Thermal Cycling	5	Toperating = min to max, Vin = min to max, full load, 100 cycles
Design Marginality	5	Tmin-10 °C to Tmax+10 °C, 5 °C steps, Vin = min to max, 0-105% load
Damp Heat, Cyclic	5	EN 60068-2-30:2005
Solderability	15	Pins MIL-STD-883, method 2003

Note: Governing Standard BS EN 50155:2007 Railway applications - Electronic equipment used on rolling stock

EN50155 Requirements and RailQor Features

RailQor Capabilities			
Input Ratio	Family	Continuous Input	Transient Input
2:1	RQ72	42 V – 110 V	42 V – 150 V (1s)
2:1	RQ1B	66 V – 160 V	66 V – 200 V (1s)
4:1	RQ18	9 V – 36 V	9 V – 40 V (1s)
4:1	RQ36	18 V – 75 V	18 V – 80 V (1s)
4:1	RQ90	34 V – 160 V	34 V – 200 V (1s)
12:1	RQ68	12 V – 155 V	12 V – 170 V (1s)

EN50155 Requirements		
Nominal	Continuous Input	Transient Input
72 V	50 V – 90 V	43 V – 101 V
110 V	77 V – 137 V	66 V – 160 V
24 V	17 V – 30 V	14 V – 34 V
72 V – 110 V	50 V – 137 V	43 V – 160 V
24 V – 110 V	17 V – 137 V	14 V – 160 V



DC Filter Modules for the Rail Transportation Industry

RailQor series of EMI filters brings SynQor’s field proven technology and manufacturing expertise to the industrial power applications marketplace. SynQor’s innovative packaging approach ensures survivability in the most hostile environments. Compatible with the industry standard format, these filters have high differential-mode and common-mode attenuation, low DC resistance, and a stabilizing bulk capacitor resistor. They follow conservative component derating guidelines and they are designed and manufactured to the highest standards.

Operational Features

- Very Low DC resistance
- Differential-mode attenuation >80 dB @ 250 kHz
- Common-mode attenuation >50 dB @ 250 kHz
- All capacitors are X7R multi-layer ceramic
- No electrolytic capacitors (all ceramic design)
- High-voltage isolation between chassis and input / output
- Wide temperature range operation
- -40 °C to +100 °C Operating Temperature
- Meets requirements of standard EN 50155

Model Number	Input Voltage		Output Current	Isolation Voltage (to common-mode / baseplate)	Maximum DC Resistance @ 100 °C	Differential-Mode Attenuation	Common-Mode Attenuation
	Continuous	Surge (<100ms)					
QUARTER BRICK							
RQ200PFQTx10	±200 V	±250 V	10 A	3000 V	70 mΩ	>80 dB @ 250 kHz	>50 dB @ 250 kHz

RailQor DC Filter

Family	Cont. Input Voltage	Filter Type	Package Size	Performance Series	Thermal Design	Max. Iout	Options Description		
							Enable Logic	Pin Length	Features
RQ	200: ±200 V	PF: Passive Filter	Q: Quarter Brick	T: Tera	C: Encased V: Flanged Baseplate	10: 10 A	S: Standard	R: 0.180"	S: Standard

Example: RQ200PFQTC10NRS-G For valid part numbers, refer to the website or contact your local sales representative or distributor.



Next-Generation, Ruggedized Isolated DC-DC Converters for Industrial Applications

SynQor's ruggedized InQor DC-DC converters and filters are designed for a wide range of industrial applications including those required to withstand harsh environments: railway and transportation systems, industrial motion control, information displays, factory automation and power generation systems. SynQor converters feature a two-stage power topology with synchronous-rectification that greatly improves efficiency and optimizes the power dissipated by the converter.

Operational Features

- High efficiency up to 95%
- Input voltage ranges from 9 V to 425 V
- Output power up to 600 W
- Fixed frequency switching, low output noise
- No minimum load requirement
- Full Feature options available on some models
- Industry standard pin-out configurations and standard footprints
- Operating Temperature -40 °C to +100 °C
- Output Voltage Set Point ±1.0%
- Output Voltage Ripple <1% of Vout (typ.) pk-pk
- Isolation Voltage Up to 4250 Vdc

Protection/Control Features

- Input under-voltage lockout
- Output current limit and short circuit protection
- Active back bias limit prevents damage to converter from external load induced pre-bias
- Digital output current sharing (Half Brick Zeta only)
- Output over-voltage protection
- Thermal shutdown
- Trimmable output voltages



InQor Isolated DC-DC Converter

Family	Cont. Input Voltage	Output Voltage	Package Size	Performance Series	Thermal Design	Max. Output Current	Options Description		
							Enable Logic	Pin Length	Features
IQ	12: 9-22 V	012: 1.2V	S: Sixteenth Brick Q: Quarter Brick H: Half Brick F: Full Brick	K: Kilo M: Mega G: Giga T: Tera P: Peta E: Exa Z: Zeta	C: Encased D: Encased, Non-threaded Baseplate V: Encased, Flanged Baseplate	60: 60 A 50: 50 A 30: 30 A 10: 10 A 06: 6 A 02: 2 A (not all shown)	N: Negative	R: 0.180"	S: Standard F: Full Feature
	18: 9-36 V	015: 1.5V							
	24: 18-36 V	018: 1.8V							
	32: 9-75 V	025: 2.5V							
	36: 18-75 V	033: 3.3V							
	48: 34-75 V	050: 5V							
	64: 18-135 V	070: 7V							
	68: 12-150 V	120: 12V							
	70: 34-135 V	150: 15V							
	72: 42-110 V	240: 24V							
	90: 34-160 V	280: 28V							
	1B: 66-160 V	300: 30V							
	2H: 90-210 V	400: 40V							
	4H: 180-425 V	480: 48V							
	500: 50V								

Example: IQ1B480QTC03NRS-G For valid part numbers, refer to the website or contact your local sales representative or distributor.

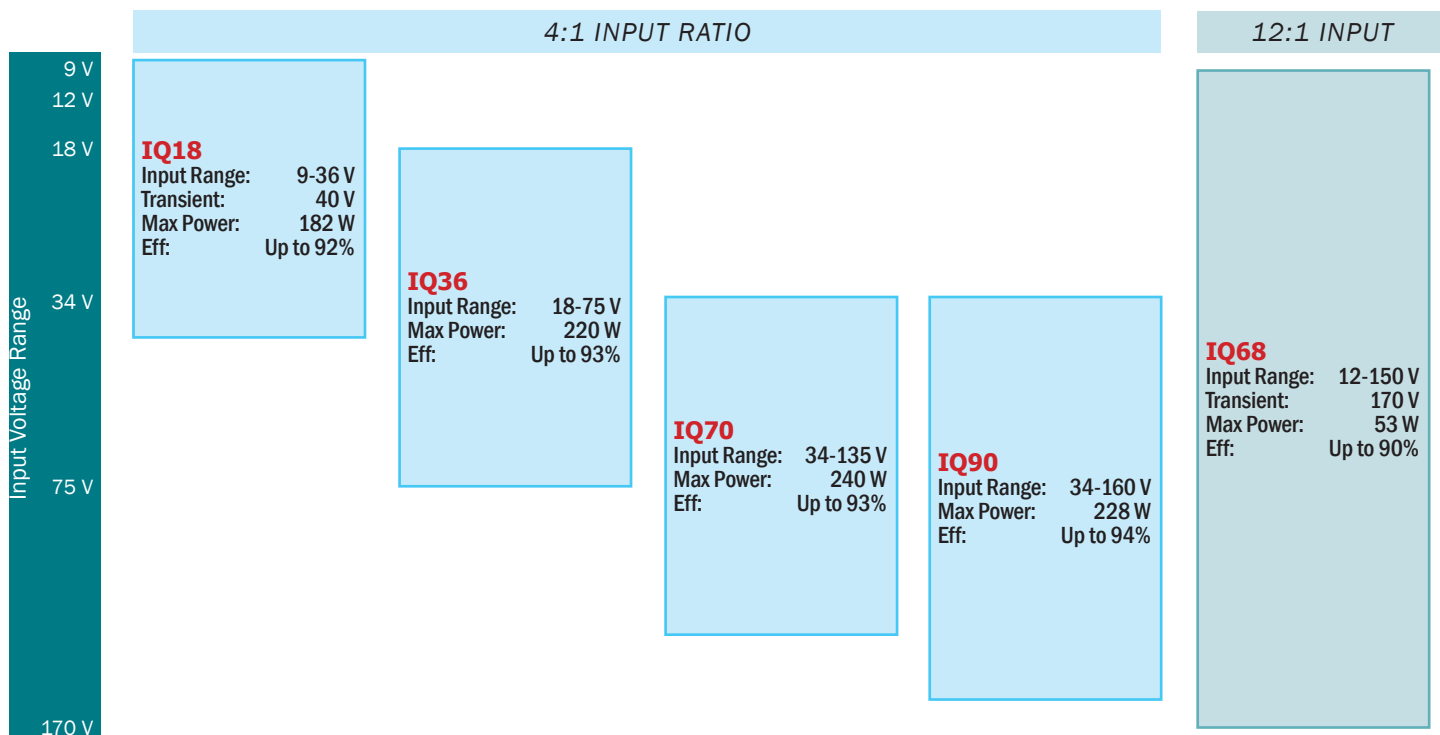
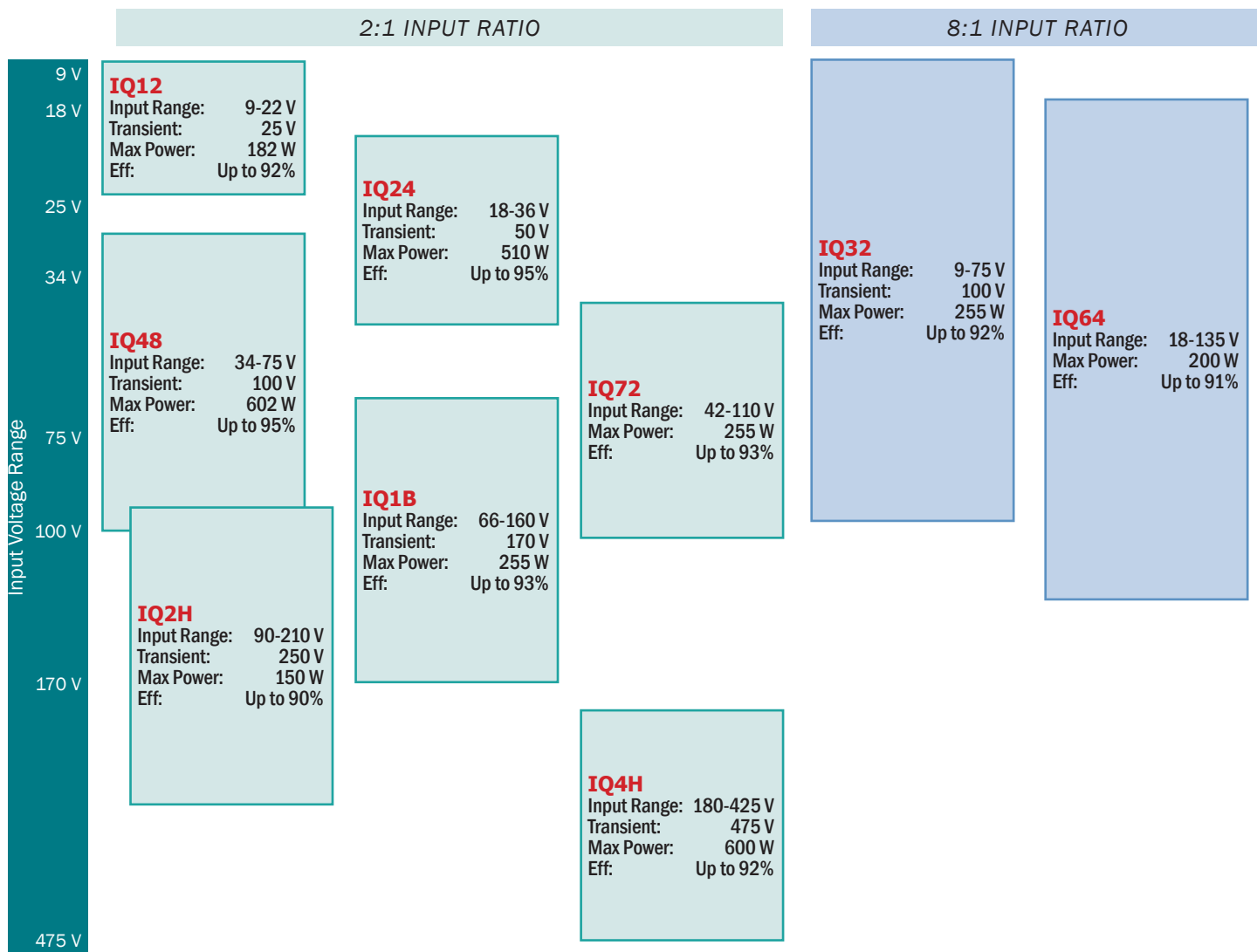



IQ12		Vout	3.3 V	5 V	7 V	12 V	15 V	24 V	28 V	30 V	40 V	48 V
12 Vdc Input (9-22 Vdc Input Range, Transient 25 V)												
Half Brick	HPC		50 A 165 W	36 A 180 W		15 A 180 W	12 A 180 W	7.5 A 180 W	6.5 A 182 W		4.5 A 180 W	3.7 A 178 W
	HTC		40 A 132 W	28 A 140 W		12 A 144 W	9.5 A 143 W	6 A 144 W	5 A 140 W		3.5 A 140 W	3 A 144 W
Quarter Brick	QTC		30 A 99 W	20 A 100 W	14 A 98 W	8 A 96 W	7 A 105 W	4 A 96 W		3 A 90 W		2 A 96 W
	QGC		20 A 66 W	15 A 75 W	10 A 70 W	6 A 72 W	5 A 75 W	3 A 72 W		2.4 A 72 W		1.5 A 72 W

IQ24		Vout	1.8 V	3.3 V	5 V	7 V	12 V	15 V	24 V	28 V	30 V	40 V	48 V	50 V
24 Vdc Input (18-36 Vdc Input Range, Transient 50 V)														
Half Brick	HZC				60 A 300 W		42 A 504 W	34 A 510 W	21 A 504 W	18 A 504 W		12.5 A 500 W		10 A 500 W
	HEC									14 A 392 W				8 A 400 W
	HPC		60 A 108 W	50 A 165 W	40 A 200 W		18 A 216 W	15 A 225 W	9 A 216 W	7.5 A 210 W		5.5 A 220 W	4.5 A 216 W	
	HTC			40 A 132 W	30 A 150 W		13 A 156 W	10 A 150 W	6.5 A 156 W	5.5 A 154 W		4 A 160 W	3.3 A 158 W	
Quarter Brick	QTC			30 A 99 W	24 A 120 W	17 A 119 W	10 A 120 W	8 A 120 W	5 A 120 W		4 A 120 W		2.5 A 120 W	
	QGC			25 A 83 W	18 A 90 W	13 A 91 W	7.5 A 90 W	6 A 90 W	3.7 A 89 W		3 A 90 W		1.8 A 91 W	
	QMC										2 A 60 W		1.2 A 58 W	
Sixteenth Brick	SGC		15 A 50 W	10 A 50 W	7 A 49 W	4 A 48 W	3.3 A 48 W	2 A 48 W	1.8 A 50 W			1 A 48 W		

IQ48		Vout	1.8 V	3.3 V	5 V	7 V	12 V	15 V	24 V	28 V	30 V	40 V	48 V	50 V
48 Vdc Input (34-75 Vdc Input Range, Transient 100 V)														
Half Brick	HZC				60 A 300 W		50 A 600 W	40 A 600 W	25 A 600 W	21.5 A 602 W		15 A 600 W		12 A 600 W
	HPC			60 A 198 W	46 A 230 W		21 A 252 W	17 A 255 W	10.5 A 252 W	9 A 252 W			5.2 A 250 W	
	HTC			45 A 149 W	34 A 170 W		16 A 192 W	13 A 195 W	8 A 192 W	7 A 196 W			4 A 192 W	
Quarter Brick	QTC			30 A 99 W	25 A 125 W	20 A 140 W	12 A 144 W	10 A 150 W	6 A 144 W		5 A 150 W		3 A 144 W	
	QGC			25 A 83 W	21 A 105 W	15 A 105 W	9 A 108 W	7 A 105 W	4.5 A 108 W		3.5 A 105 W		2.2 A 106 W	
Sixteenth Brick	SGC		28 A 50 W	15 A 50 W	10 A 50 W	7 A 50 W	4.1 A 50 W	3.3 A 50 W		1.8 A 50 W				

2:1 Input Ratio

IQ72		Vout	3.3 V	5 V	7 V	12 V	15 V	24 V	28 V	30 V	48 V
72 Vdc Input (42-110 Vdc Input Range)											
Half Brick	HPC					21 A 252 W	17 A 255 W	10.4 A 250 W	9 A 252 W		5.2 A 250 W
Quarter Brick	QTC	30 A 99 W	25 A 125 W	20 A 140 W	12 A 144 W	10 A 150 W	6 A 144 W			5 A 150 W	3 A 144 W
	QGC	25 A 83 W	20 A 100 W	15 A 105 W	9 A 108 W	7 A 105 W	4.5 A 108 W				2 A 96 W

IQ1B		Vout	3.3 V	5 V	7 V	12 V	15 V	24 V	28 V	30 V	40 V	48 V
110 Vdc Input (66-160 Vdc Input Range, Transient 170 V)												
Half Brick	HPC			48 A 240 W		21 A 252 W	17 A 255 W	10 A 240 W	9 A 252 W		6.3 A 252 W	5.2 A 250 W
	HTC			34 A 170 W		16 A 192 W	13 A 195 W	8 A 192 W	7 A 196 W		5 A 200 W	4 A 192 W
Quarter Brick	QTC	30 A 99 W	25 A 125 W	20 A 140 W	12 A 144 W	10 A 150 W	6 A 144 W			5 A 150 W		3 A 144 W
	QGC	23 A 76 W	18 A 90 W	15 A 105 W	9 A 108 W	7 A 105 W	4.5 A 108 W			3.5 A 105 W		2 A 96 W

IQ2H		Vout	5 V	28 V	48 V
150 Vdc Input (90-210 Vdc Input Range, Transient 250 V)					
Quarter Brick	QTC		30 A 150 W	5.35 A 150 W	3.13 A 150 W

IQ4H		Vout	3.3 V	5 V	12 V	15 V	24 V	28 V	40 V	48 V
385 Vdc Input (180-425 Vdc Input Range, Transient 475 V)										
Full Brick	FTC			80 A 400 W	50 A 600 W	40 A 600 W	25 A 600 W	21.4 A 600 W	15 A 600 W	12.5 A 600 W
Half Brick	HTC	60 A 198 W		50 A 250 W	25 A 300 W	20 A 300 W	12.5 A 300 W	10.7 A 300 W		6.3 A 300 W
Quarter Brick	QTC	30 A 99 W		30 A 150 W	13 A 156 W	10 A 150 W	6.25 A 150 W	5.35 A 150 W		3.13 A 150 W



4:1 Input Ratio

IQ18		Vout	1.8 V	3.3 V	5 V	7 V	12 V	15 V	24 V	28 V	30 V	40 V	48 V
18 Vdc Input (9-36 Vdc Input Range, Transient 40 V)													
Half Brick	HPC		50 A 165 W	36 A 180 W		15 A 180 W	12 A 180 W	7.5 A 180 W	6.5 A 182 W		4.5 A 180 W	3.7 A 178 W	
	HTC		40 A 132 W	28 A 140 W		12 A 144 W	9.5 A 143 W	6 A 144 W	5 A 140 W		3.5 A 140 W	3 A 144 W	
Quarter Brick	QTC		30 A 99 W	20 A 100 W	14 A 98 W	8 A 96 W	7 A 105 W	4 A 96 W		3 A 90 W		2 A 96 W	
	QGC		20 A 66 W	15 A 75 W	10 A 70 W	6 A 72 W	5 A 75 W	3 A 72 W		2.4 A 72 W		1.5 A 72 W	
Sixteenth Brick	SGC	25 A 45 W	15 A 50 W	10 A 50 W	7.1 A 50 W	4 A 48 W	3.3 A 50 W	2 A 48 W				1 A 48 W	

IQ36		Vout	3.3 V	5 V	7 V	12 V	15 V	24 V	28 V	30 V	40 V	48 V	
36 Vdc Input (18-75 Vdc Input Range)													
Half Brick	HPC	50 A 165 W	40 A 200 W	30 A 210 W	18 A 216 W	14 A 210 W	9 A 216 W	7.5 A 210 W		5.5 A 220 W	4.5 A 216 W		
	HTC	40 A 132 W	30 A 150 W	22 A 154 W	13 A 156 W	10 A 150 W	6.5 A 156 W	5.5 A 154 W		4 A 160 W	3.2 A 154 W		
Quarter Brick	QTC	30 A 99 W	24 A 120 W	17 A 119 W	10 A 120 W	8 A 120 W	5 A 120 W		4 A 120 W		2.5 A 120 W		
	QGC	25 A 83 W	18 A 90 W	13 A 91 W	7.5 A 90 W	6 A 90 W	3.7 A 89 W		3 A 90 W		1.8 A 86 W		

IQ70		Vout	3.3 V	5 V	7 V	12 V	15 V	24 V	28 V	30 V	48 V		
70 Vdc Input (34-135 Vdc Input Range)													
Half Brick	HPC		44 A 220 W			20 A 240 W	16 A 240 W	10 A 240 W	8.5 A 238 W		5 A 240 W		
Quarter Brick	QTC	30 A 99 W	24 A 120 W	18 A 126 W	11 A 132 W	8.6 A 129 W	5.5 A 132 W		4.4 A 132 W		2.7 A 130 W		

IQ90		Vout	3.3 V	5 V	7 V	12 V	15 V	24 V	28 V	30 V	48 V		
90 Vdc Input (34-160 Vdc Input Range)													
Half Brick	HPC		40 A 200 W			19 A 228 W	15 A 225 W	9.5 A 228 W	8 A 224 W		4.6 A 221 W		
Quarter Brick	QTC	30 A 99 W	24 A 120 W	17 A 119 W	10 A 120 W	8 A 120 W	5 A 120 W		4 A 120 W		2.5 A 120 W		
	QGC	23 A 76 W	17 A 86 W	12 A 84 W	7 A 84 W	5.5 A 83 W	3.5 A 84 W		2.8 A 84 W		1.8 A 86 W		
	QMC	15 A 50 W	10 A 50 W	7 A 49 W	4 A 48 W	3.3 A 50 W	2 A 48 W		1.6 A 48 W		1 A 48 W		

8:1 Input Ratio

IQ32	Vout	3.3 V	5 V	7 V	12 V	15 V	24 V	28 V	30 V	40 V	48 V	50 V
32 Vdc Input (9-75 Vdc Input Range, Transient 100 V)												
Half Brick	HZC		50 A 250 W		21 A 252 W	17 A 255 W	10 A 240 W	9 A 252 W		6 A 240 W		5 A 250 W
	HPC	45 A 149 W	32 A 160 W		13 A 156 W	11 A 165 W	6.7 A 161 W	5.8 A 162 W		4 A 160 W	3.4 A 163 W	
	HTC	33 A 109 W	24 A 120 W		10 A 120 W	8 A 120 W	5 A 120 W	4.5 A 126 W		3 A 120 W	2.5 A 120 W	
Quarter Brick	QTC	25 A 83 W	17 A 85 W	12 A 84 W	7 A 84 W	5.5 A 83 W	3.5 A 84 W		2.8 A 84 W		1.8 A 86 W	
	QGC	15 A 50 W	10 A 50 W	7 A 49 W	4 A 48 W	3.3 A 50 W	2 A 48 W		1.6 A 48 W		1 A 48 W	

IQ64	Vout	3.3 V	5 V	7 V	12 V	15 V	24 V	28 V	30 V	40 V	48 V
64 Vdc Input (18-135 Vdc Input Range)											
Half Brick	HPC	50 A 165 W	36 A 180 W		16 A 192 W	13 A 195 W	8 A 192 W	7 A 196 W		5 A 200 W	4 A 192 W
Quarter Brick	QTC	27 A 89 W	20 A 100 W	14 A 98 W	8 A 96 W	6.5 A 98 W	4 A 98 W		3.2 A 96 W		2 A 96 W
	QGC		10 A 50 W		4 A 48 W	3.3 A 50 W	2 A 48 W				1 A 48 W

12:1 Input Ratio

IQ68	Vout	5 V	12 V	24 V	48 V
68 Vdc Input (12-150 Vdc Input Range, Transient 170 V)					
Half Brick	HGC	10.6 A 53 W	4.4 A 53 W	2.2 A 53 W	
Quarter Brick	QMC	5.3 A 25 W	2.2 A 26 W	1.1 A 26 W	0.55 A 26 W



See “Encased Package Configurations” on page 95 for package outlines.



DC Filter Modules for DC-DC Converters

SynQor provides EMI filters for InQor® DC-DC converters. All EMI filters provide high levels of differential-mode and common-mode attenuation and include stabilizing bulk capacitors and damping resistors.

Operational Features

- Low DC resistance
- Differential-mode attenuation
- Common-mode attenuation
- Bulk capacitance provides input system stabilization for downstream power converters
- No electrolytic capacitors (all ceramic design)
- High-voltage isolation between chassis and input / output
- Wide temperature range operation
- -40 °C to +100 °C Operating Temperature

Model Number	Input Voltage		Output Current	Isolation Voltage (to common-mode / baseplate)	Maximum DC Resistance @ 100 °C	Differential-Mode Attenuation	Common-Mode Attenuation
	Continuous	Surge (<100ms)					
QUARTER BRICK							
IQ040PFQTx30	±40 V	±50 V	30 A	2250 V	20 mΩ	>80 dB @ 250 kHz	>36 dB @ 250 kHz
IQ080PFQTx20	±80 V	±100 V	20 A	2250 V	32 mΩ	>80 dB @ 250 kHz	>36 dB @ 250 kHz
IQ200PFQTx10	±200 V	±250 V	10 A	2250 V	70 mΩ	>80 dB @ 250 kHz	>50 dB @ 250 kHz
IQ500PFQTx04	±500 V	±630 V	4.0 A	2500 V	180 mΩ	>80 dB @ 500 kHz	>50 dB @ 500 kHz

InQor DC Filter

Family	Cont. Input Voltage	Filter Type	Package Size	Performance Series	Thermal Design	Max. Iout	Options Description		
							Enable Logic	Pin Length	Features
IQ	040: ±40 V 080: ±80 V 200: ±200 V 500: ±500 V	PF: Passive Filter	Q: Quarter Brick	T: Tera	C: Encased V: Flanged Baseplate	30: 30 A 20: 20 A 10: 10 A 04: 4 A	S: Standard	R: 0.180"	S: Standard

Example: IQ080PFQTC20NRS-G For valid part numbers, refer to the website or contact your local sales representative or distributor.

See “Encased Package Configurations” on page 95 for package outlines.

NiQor®

High-Voltage Non-Isolated Converters



High Voltage, Non-Isolated DC-DC Converters for Industrial Applications

The high input voltage NiQor® family of DC-DC converters offers unique solutions for converting high-powered, variable voltages to a wide range of output voltages. The converter is a non-isolated buck-boost regulator, which employs synchronous rectification to achieve extremely high conversion efficiency. These products are suitable for use in Intermediate Bus Architecture, or to provide a regulated output voltage from a variable voltage source such as a battery. They can be configured to ‘buck’ the input voltage down or ‘boost’ the input voltage up using a single external resistor.

Operational Features

- Ultra-high efficiency up to 96%
- Wide input voltage ranges:
 - 9-20 V (NQ20)
 - 9-40 V (NQ40)
 - 9-60 V (NQ60)
 - 9-90 V (NQ90)
- Buck or Buck/Boost Mode available
- Maximum input/output currents up to 55 A
- Suitable for use in Intermediate Bus Architectures
- On-board input and output filtering
- No minimum load requirement
- -40 °C to +100 °C Operating Temperature
- Remote sense and wide output voltage trim

Protection/Control Features

- Input under-voltage lockout (UVLO)
- Output current limit (OCP) and short circuit protection
- Output over-voltage protection (OVP)
- Thermal shutdown (OTP)
- Output voltage trim

BATTERY CHARGING

- Provides the power conversion platform for battery charging
- Output current limit is externally controlled for constant-current charging
- Current can be set with an external resistor or an active circuit
- Current analog signal provided for instrumentation and control functions
- Ideal diode output stage with zero back-drive currents prevents discharge of battery when not charging
- Output voltage set-point is independently controlled through trim pin
- Unit will smoothly transition between current and voltage modes as charging cycle needs charge



NQ 20	Series	0-20 V
9-20 Vdc Input Range		
Quarter Brick	QG	40 A
Eighth Brick	ET	20 A
	EG	10 A

NQ 40	Series	0-40 V
9-40 Vdc Input Range		
Half Brick	HG	55 A
Quarter Brick	QT	35 A
	QG	30 A
Eighth Brick	EP	20 A
	ET	15 A
	EG	8 A

NQ 60	Series	0-60 V
9-60 Vdc Input Range		
Half Brick	HG	40 A
Quarter Brick	QT	25 A
	QG	20 A
Eighth Brick	EP	15 A
	ET	10 A
	EG	5 A

NQ 90	Series	0-90 V
9-90 Vdc Input Range		
Half Brick	HG	26 A
Quarter Brick	QT	18 A
Eighth Brick	EP	10 A

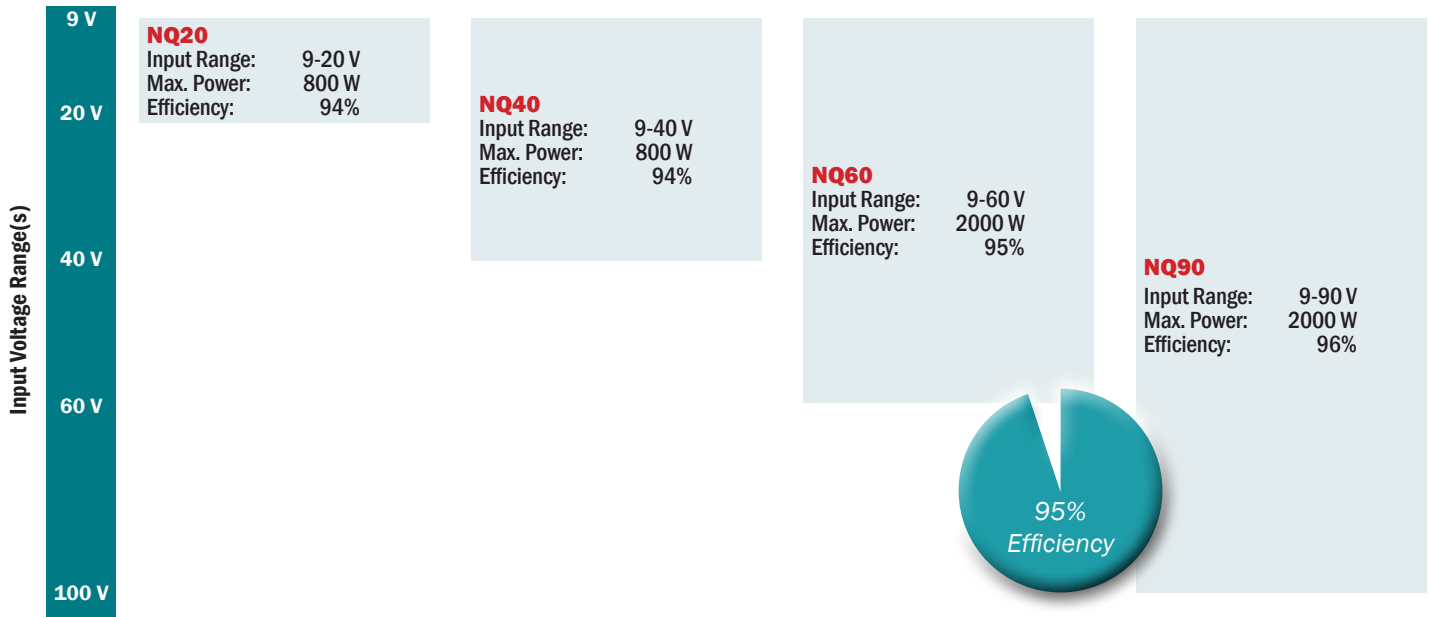

NiQor High-Voltage Non-Isolated DC-DC Converters

Family	Input Voltage	Mode	Output Voltage	Package Size	Series	Thermal Design	Maximum Current	Options Description:		
								Enable Logic	Pin Length	Feature Set
NQ	20: 9-20 V 40: 9-40 V 60: 9-60 V 90: 9-90 V	T: Buck (1/8 & 1/4) W: Buck/Boost	20: 0-20 V 40: 0-40 V 60: 0-60 V 90: 0-90 V	E: Eighth Brick Q: Quarter Brick H: Half Brick	G: Giga T: Tera P: Peta	C: Encased D: Encased, Non-threaded Baseplate V: Encased, Flanged Baseplate	05: 5 A 08: 8 A 10: 10 A 15: 15 A 20: 20 A 26: 26 A 30: 30 A 40: 40 A 55: 55 A	N: Neg.	K: 0.110" N: 0.145" R: 0.180" Y: 0.250"	S: Standard (1/8 & 1/4 only) C: Current monitor output/trimmable current limit (1/8 & 1/4 only) F: Current share/trimmable current limit (half brick only)

Example: NQ20W20ETC20NRS-G For valid part numbers, refer to the website or contact your local sales representative or distributor.



Power Factor Correction Modules

The PFCQor® Power Factor Correction module is an essential building block of an AC-DC power supply. Used in conjunction with a hold-up capacitor, SynQor’s high efficiency DC-DC converters and SynQor’s AC line filter, the PFCQor will draw a nearly perfect sinusoidal current (PF>0.99) from a single phase AC input. Up to three PFCQor modules can be paralleled to achieve higher power. The module is supplied completely encased to provide protection from the harsh conditions seen in many industrial and transportation environments.

Operational Features

- Universal input voltage range: 85-264 Vrms*
- Universal input frequency range: 47 - 63 Hz / 360 - 800 Hz
- Up to 700 W output power
- ≥0.99 Power Factor
- High efficiency: >96% (230 Vrms), >94% (115 Vrms)
- Internal inrush current limit
- Auxiliary 10 V bias supply
- 100 °C max baseplate temperature at full power
- -40 °C to +100 °C Operating Temperature
- Up to three modules can be paralleled with current sharing
- Compatible with SynQor IQ4H Converters and AC line filters

Protection/Control Features

- PFC Enable
- Load Enable (also: Power Out Good signal)
- AC Power Good Signal (HB only)
- Clock synchronization (HB only)
- Output current monitor / active current sharing (HB only)
- Input current limit along with auto-recovery short circuit protection
- Auto-recovery input under / over-voltage protection
- Auto-recovery output over-voltage protection
- Auto-recovery thermal shutdown

See “Encased Package Configurations” on page 95 for package outlines.

PFCQor Power Factor Correction

Family	Vin Range	Vout	Package Size	Perf. Level	Thermal Design	Output Power	Input Phases	Pin Style	Feature Set
PFC	U: 85-264 Vrms	390: 390 V	H: Half-brick Q: Quarter-brick	P: Peta	C: Encased D: Encased, Non-threaded Baseplate V: Encased, Flanged Baseplate	07: 700 W 04: 350 W	S: Single-Phase	R: 0.180"	S: Supports Parallel Capability (Half-brick only) S: Standard Not Parallel Capability (Quarter-brick only)

Example: PFCU390HPC07SRS-G For valid part numbers, refer to the website or contact your local sales representative or distributor.

* The label shows a narrower input voltage range to be consistent with labeling requirements of IEC60950-1, Section 1.7

Model Number	Input Voltage	Output Voltage	Max Output Power
PFCU390HPx07SRS	85-264 Vrms	390 Vdc	700 W
PFCU390QPx04SRS	85-264 Vrms	390 Vdc	350 W



PFICQor™

Isolated Power Factor Correction



Isolated Power Factor Correction Modules

The PFICQor Isolated Power Factor Correction module is a high power, high efficiency AC-DC converter. It operates from a universal AC input and generates an isolated output. Both regulated and semi-regulated (droop version) modules are available. Used in conjunction with a hold-up capacitor, and SynQor’s AC line filter, the PFICQor will draw a nearly perfect sinusoidal current (PF>0.99) from a single phase AC input. The module is supplied completely encased to provide protection from the harsh environments seen in many industrial and transportation environments.

Operational Features

- Isolated output, 325 W output power
- Universal input frequency range: 47 - 63 Hz / 360 - 800 Hz
- Input voltage range: 85-264 Vrms
- ≥0.99 Power Factor
- High efficiency: >92% (230 Vrms)
- Internal inrush current limit
- Auxiliary 10 V bias supply, primary-side referenced
- Can be paralleled (droop version only)
- -40 °C to +100 °C Operating Temperature
- Compatible with SynQor AC line filters

Protection/Control Features

- PFC Enable
- AC Power Good Signal
- DC Power Good Signal
- Input current limit and auto-recovery short circuit protection
- Auto-recovery input under / over-voltage protection
- Auto-recovery over-voltage protection
- Auto-recovery thermal shutdown

See “Encased Package Configurations” on page 95 for package outlines.

PFICQor Isolated Power Factor Correction

Family	Vin Range	Vout	Package Size	Perf. Level	Thermal Design	Output Current	Enable Logic	Pin Style	Feature Set
PFIC	U: 85-264 Vrms	12: 12 V 24: 24 V 28: 28 V 48: 48 V	H: Half-brick	T: Tera	C: Encased D: Encased, Non-threaded Baseplate V: Encased, Flanged Baseplate	07: 7 A 12: 12 A 14: 14 A 27: 27 A	N: Negative	R: 0.180"	S: Standard D: Droop

Example: PFICU12HTC27NRS-G For valid part numbers, refer to the website or contact your local sales representative or distributor.



AC Line Filter Modules

SynQor provides AC Line filters for the Industrial PFC modules and DC-DC converters. SynQor’s high-performance filters are designed to comply with industry EMI standards.

Operational Features

- Universal Input voltage range
- 1 kW @ 115 V or 2 kW @ 230 V
- All ceramic capacitor design
- Internally damped
- -40 °C to +100 °C Operating Temperature
- Low power dissipation
- Complies with industry EMI standards when used with SynQor PFC and DC-DC converter modules
- High voltage isolation between baseplate and input/output

InQor AC Line Filter

Family	Input Frequency	Package Size	Performance Level	Thermal Design	Input Voltage	Pin Style	Feature Set
ACLF	060: 50 / 60 Hz UNV: 50 / 60 Hz & 400 Hz	E: Eighth Brick H: Half Brick	T: Tera	C: Encased D: Encased, Non-threaded Baseplate V: Encased, Flanged Baseplate	230: 85-264 Vrms	R: 0.180"	S: Standard

Example: ACLF060HTC230RS-G For valid part numbers, refer to the website or contact your local sales representative or distributor.

Model Number	AC Line Frequency	AC Line Voltage	Output Current	P _{OUT} ^{MAX} (115 V / 230 V)	Dissipation P _{OUT} ^{MAX}	Isolation Voltage (to baseplate)
ACLFUNVETx230	50 / 60 Hz & 400 Hz	85-264 Vrms	5 Arms	500 W / 1 kW	4.5 W	2150 V _{PK}
ACLF060HTx230	50 / 60 Hz	85-264 Vrms	9 Arms	1 kW / 2 kW	15.8 W	2150 V _{PK}



E-Series

G-Series

Industrial-Grade Highly Efficient AC-DC Power Supplies with PFC

The ACuQor® product line offers best-in-class solutions for AC-DC power supplies designed to meet an extensive range of applications. The E-Series packages 500 W of useable power into just 3.50" x 5.25" x 1.63" (Encased). The G-Series provides 1400 W of useable power in a 4.75" x 7.00" x 1.63" package.

Product Features

- High efficiency up to 93% at full rated load current
- Delivers up to 1400 W of output power (1800 W transient)
- Semi-regulated output
- -Universal input voltage range (85-264 Vrms)
- Operating ambient temperature: -40 °C to +70 °C
- 5 V (500mW) standby output

Protection/Control Features

- Over-current, over-voltage, and over-temp protection
- DC Power Good and AC Power Good signals
- Remote enable input
- Parallel operation available, up to 3 units to be connected
- Parallel option units may still be used as stand-alone

ACuQor AC-DC Converter

Family	Output Power	Grade	Range	Output Voltage	Package Size	Thermal Design	Options
AQ	0300: 300 W 0400: 400 W 0500: 500 W 0800: 800 W 1100: 1100 W 1400: 1400 W	I: Industrial	U: Universal (85-264 Vrms)	12: 12 V 1T: 12 V/12 V/5 V 15: 15 V 24: 24 V 2T: 24 V/12 V/5 V 28: 28 V 36: 36 V 3T: 36 V/12 V/5 V 48: 48 V 4T: 48 V/12 V/5 V	E: 1 Unit 3" x 5" (Open Frame) G: 1 Unit 4.75" x 7"	A: Open-frame C: Encased	IND: Industria Grade INP: Parallel*

Example: AQ0400IU24ECIND For valid part numbers, refer to the website or contact your local sales representative or distributor.

* Parallel output capable with up to 3 units on 800 W, 1100 W & 1400 W models, 12 V and 15 V outputs excluded.

Output Voltage	Power Rating		
G-Series (Single Output) (4.75" x 7.00" x 1.63" Encased Package) 12 V, 15 V, 24 V, 28 V, 48 V (includes 5 V@ 100mA standby)	800 W (1000 W Transient)	1100 W (1300 W Transient)	1400 W (1800 W Transient)
E-Series (Single Output) (3.00" x 5.00" x 1.46" Open Frame Package) (3.50" x 5.25" x 1.63" Encased Package) 12 V, 24 V, 36 V or 48 V (includes 5 V@ 50mA standby)	300 W (400 W Transient)	400 W (500 W Transient)	500 W (700 W Transient)
E-Series (Triple Output) (3.00" x 5.00" x 1.46" Open Frame Package) (3.50" x 5.25" x 1.63" Encased Package) 12 V, 24 V, 36 V or 48 V (includes 5 V@ 2 A and 12 V@ 4.2 A)	300 W (400 W Transient)	400 W (500 W Transient)	500 W (700 W Transient)

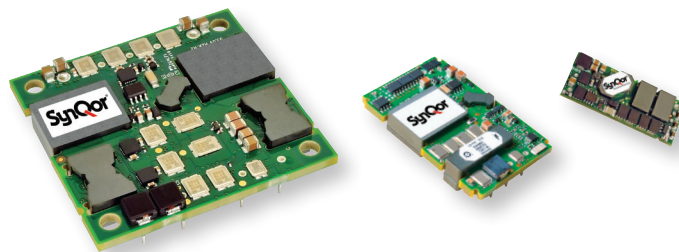

24 V and 48 V Input, Single and Dual Output Isolated

DC-DC Converters for Telecom/Network Applications

Single and dual output converters are composed of next-generation, board-mountable, isolated, fixed switching frequency DC-DC converters that use synchronous rectification to achieve extremely high power conversion efficiency. The power dissipated by the converter is so low that a heatsink is not required, which saves cost, weight, height, and application effort. All of the power and control components are mounted to the multi-layer PCB substrate.

Operational Features

- Ultra-high efficiency up to 97%
- Wide input voltage ranges:
 - 18-36 V (PQ24)
 - 18-60 V (PQ30)
 - 18-75 V (PQ40)
 - 35-75 V (PQ48, PQ60, DQ6)
 - 44-52 V (PQ50)
 - 38-55 V (PQ55)
 - 40-75 V (PQ65)
- Withstand up to 100 V, 100ms input voltage transient (PQ60, PQ40 models only)
- Fixed frequency switching, low output noise
- No minimum load requirement (except PQ60525HTA04)
- Full Feature optional on some models

General Specifications

- Operating Temperature -40 °C to +100 °C
- Output Voltage Set Point ±1.0% to 1.5%
- Output Voltage Trim Range
 - Sixteenth Brick +10% to -10%
 - Half Brick Zeta +10% to -50%
- Output Voltage Ripple <1% of Vout (typ.) pk-pk
- Input Ref. Ripple Current <1% of Iin (typ.) rms
- Switching Frequency 200 - 300 kHz
- Isolation Voltage Up to 2250 Vdc
- Industry standard pin-out configurations and standard footprints

Protection/Control Features

- Input under-voltage lockout (UVLO)
- Output current limit (OCP) and short circuit protection
- Output over-voltage protection (OVP)
- Thermal shutdown (OTP)
- Back-drive protection (starts into pre-biased load)
- On/Off control referenced to input side (Fully isolated for Full Bricks)
- Remote sense
- Output voltage trim (industry std. trim equations)
- Digital Output Current Sharing (HZ only)

See "Open Frame Package Configurations" on page 94 for package outlines.



18 V	PQ24 Input Range: 18-36 V Transient: 50 V Max. Power: 300 W Efficiency: 95%	PQ30 Input Range: 18-60 V Transient: 80 V Max. Power: 100 W Efficiency: 89%	PQ40 Input Range: 18-75 V Transient: 100 V Max. Power: 100 W Efficiency: 90%	PQ48 Input Range: 35-75 V Max. Power: 165 W Efficiency: 93%	PQ60 Input Range: 35-75 V Transient: 100 V Max. Power: 602 W Efficiency: 96%	PQ65 Input Range: 40-75 V Transient: 100 V Max. Power: 100 W Efficiency: 91%	PQ55 Input Range: 38-55 V Max. Power: 400 W Efficiency: 95%	PQ50 Input Range: 44-52 V Max. Power: 660 W Efficiency: 94%

PowerQor Isolated DC-DC Converter

Family	Cont. Input Voltage	Output Voltage		Package Size	Performance Series	Thermal Design	Max. Output Current	Option Descriptions		
		010: 1 V	080: 8 V					Enable Logic	Pin Length	Feature Set
PQ	24: 18-36 V	010: 1 V	080: 8 V	E: Eighth Brick Q: Quarter Brick H: Half Brick	K: Kilo M: Mega G: Giga T: Tera P: Peta E: Exa Z: Zeta	A: Open frame B: Baseplate C: Encased D: Encased Non-threaded Baseplate L: Low profile M: Low profile Baseplate	25: 25 A 30: 30 A 40: 40 A 60: 60 A 80: 80 A A0: 100 A <i>(not all models are shown)</i>	P: Pos. N: Neg.	K: 0.110" N: 0.145" R: 0.180" Y: 0.250"	S: Standard F: Full Feature
	30: 18-60 V	012: 1.2 V	090: 9 V							
	40: 18-75 V	015: 1.5 V	120: 12 V							
	48: 35-75 V	016: 1.65 V	150: 15 V							
	50: 44-52 V	018: 1.8 V	180: 18 V							
	55: 38-55 V	020: 2 V	240: 24 V							
	60: 35-75 V	025: 2.5 V	260: 26 V							
	65: 40-75 V	033: 3.3 V	280: 28 V							
		050: 5 V	480: 48 V							
		053: 5.3 V	500: 50 V							
	060: 6 V	525: 52.5 V	530: 53 V	540: 54 V						

Example: PQ60120QZB33NNS-G For valid part numbers, refer to the website or contact your local sales representative or distributor.

DualQor Isolated DC-DC Converter

Family	Input Voltage	1st Output Voltage	2nd Output Voltage	Package Size	Series	Thermal Design	Max Power Output	Enable Logic	Pin Length	Feature Set
DQ	6: 35-75 V (100 V Trans.)	33: 3.3 V 50: 5.0 V	25: 2.5 V 33: 3.3 V	Q: Quarter Brick	K: Kilo M: Mega G: Giga	A: Open frame B: Baseplate	04: 40 W 06: 60 W	P: Pos. N: Neg.	K: 0.110" N: 0.145" R: 0.180" Y: 0.250"	S: Standard

Example: DQ65033QMA06NNS-G For valid part numbers, refer to the website or contact your local sales representative or distributor.

PQ24

Vout	1.8 V	3.3 V	5 V	12 V	15 V	28 V	50 V	
24 Vdc Input (18-36 Vdc Input Range, 50 Vdc Transient on Full Brick)								
Quarter Brick	QEx			40 A 200 W	25 A 300 W	20 A 300 W	10.7 A 300 W	6 A 300 W
	QGL		25 A 83 W					
	QGA	25 A 45 W	25 A 83 W	20 A 100 W	8.33 A 100 W	6.67 A 100 W		

PQ30

Vout	3.3 V	
24 and 48 Vdc Input (18-60 Vdc Input Range, 80 Vdc Transient)		
Quarter Brick	QGA	30 A 100 W
		25 A 83 W
Eighth Brick	EGA	20 A 66 W

PQ55

Vout	7.3 V	53 V	54 V
48 Vdc Input (38-55 Vdc Input Range)			
Half Brick	HZB	52 A 380 W	
	HEB		7.6 A 400 W
	HTL		5.1 A 275 W

PQ40

Vout	3.3 V	5 V	8 V	12 V	15 V	
24 and 48 Vdc Input (18-75 Vdc Input Range, 100 Vdc Transient)						
Quarter Brick	QGA	25 A 83 W	20 A 100 W	9 A 72 W	8.33 A 100 W	6.67 A 100 W

PQ65

Vout	18 V	
48 Vdc Input (40-75 Vdc Input Range, 100 Vdc Transient)		
Quarter Brick	QGA	5.6 A 100 W

PQ48

Vout	1.5 V	1.8 V	2 V	2.5 V	3.3 V	5 V	5.3 V	6 V	12 V	15 V
48 Vdc Input (35-75 Vdc Input Range)										
Half Brick	HTA	60 A 90 W	60 A 108 W	60 A 120 W	60 A 150 W	38 A 125 W	33 A 165 W	30 A 160 W	13.8 A 165.6 W	11 A 165 W
	HGA	40 A 60 W	40 A 72 W	40 A 80 W	40 A 100 W	40 A 132 W	30 A 150 W		12.5 A 150 W	10 A 150 W
	HMA	30 A 45 W	30 A 54 W	30 A 60 W	30 A 75 W	30 A 99 W	25 A 125 W			
	HKA	20 A 30 W	20 A 36 W	20 A 40 W	20 A 50 W	20 A 66 W	20 A 100 W			
Quarter Brick	QGA	25 A 37.5 W	25 A 45 W	25 A 50 W	25 A 62.5 W	25 A 82.5 W	20 A 100 W	17 A 102 W	8.3 A 99.6 W	6.7 A 100 W

PQ50

Vout	5 V	7.3 V	9 V	12 V	18 V
48 Vdc Input (44-52 Vdc Input Range)					
Half Brick	HZA		60 A 438 W		55 A 660 W
	HPA	50 A 250 W			
	HTA				10 A 180 W
Quarter Brick	QGB		11 A 99 W		

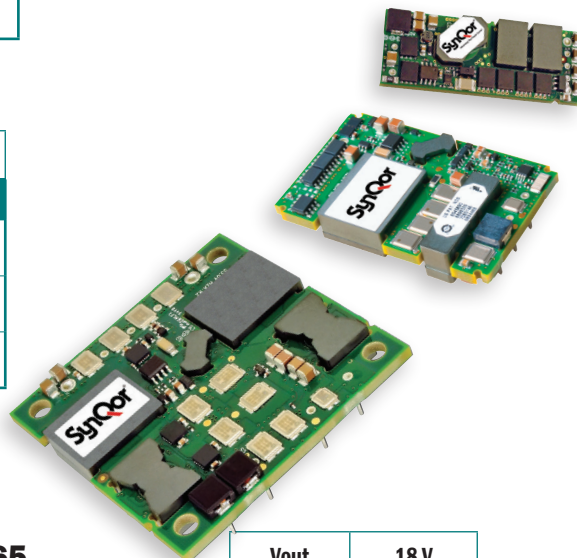



PQ60	Vout	1.2V	1.5V	1.8V	2.5V	3.3V	5V	12V	15V	18V	24V 26V	28V	40V	50V 52.5V
48 Vdc Input (35-75 Vdc Input Range, 100 Vdc Transient)														
Half Brick	HZA						60 A 300 W	50 A 600 W	40 A 600 W		25 A 600 W	21.5 A 602 W	15 A 600 W	12 A 600 W
	HEA											12.8 A 360 W		
	HPA	100 A 120 W	100 A 150 W	100 A 180 W	80 A 200 W	70 A 230 W	45 A 225 W	20 A 240 W						
	HTA	60 A 72 W	60 A 90 W			50 A 165 W	33 A 165 W	14 A 168 W		9.2 A 166 W	9.6 A 250 W			3.85 A 200 W
	HGA					40 A 132 W	30 A 150 W							
	HMA					30 A 99 W								

PQ60	Vout	1V	1.2V	1.5V	1.65V	1.8V	2.5V	3.3V	5V	6V	12V	15V	24V	48V
48 Vdc Input (35-75 Vdc Input Range, 100 Vdc Transient)														
Quarter Brick	QZB										33 A 400 W			
	QEA										25 A 300 W			
	QEA										17 A 204 W			
	QPA	60 A 60 W	60 A 72 W	60 A 90 W		60 A 108 W	60 A 150 W	45 A 150 W						
	QTA	40 A 40 W	40 A 48 W	40 A 60 W	40 A 66 W	40 A 72 W	40 A 100 W	35 A 115 W	30 A 150 W		12 A 144 W			3.0 A 144 W
	QGA			25 A 37.5 W		25 A 45 W	25 A 62.5 W	25 A 82.5 W	20 A 100 W	17 A 100 W	8.3 A 100 W		5.0 A 120 W	
	QML			15 A 22.5 W		15 A 27 W	15 A 37.5 W	15 A 50 W	15 A 75 W					
Eighth Brick	ETx			45 A 67.5 W		45 A 81 W	35 A 87.5 W	30 A 99 W						
	EGx	25 A 25 W	25 A 30 W	25 A 37.5 W		25 A 45 W	25 A 62.5 W	20 A 66 W	15 A 75 W		6.25 A 75 W	5.0 A 75 W	3.0 A 72 W	
	EGx	20 A 20 W	20 A 24 W	20 A 30 W		20 A 36 W	20 A 50 W							
	EMx	15 A 15 W	15 A 18 W	15 A 22.5 W		15 A 27 W	15 A 37.5 W	15 A 50 W	10 A 50 W		4.0 A 48 W			
	EKx		30 A 36 W	25 A 37.5 W		25 A 45 W	20 A 50 W	15 A 50 W	10 A 50 W		4.0 A 48 W	3.3 A 50 W		

DualQor®

Dual Output Isolated Converters

DQ6	Vout	2.4/1.2V	3.3/1.2V	3.3/1.5V	3.3/1.8V	3.3/2.5V	5.0/3.3V	+12/-12V
48 Vdc Input (35-75 Vdc Input Range, 100 Vdc Transient)								
Quarter Brick	QGL		15/15 A 68 W	15/15 A 72 W	15/15 A 77 W	15/15 A 87 W	10/15 A 100 W	
	QMA				12/22 A 40 W	12/16 A 40 W	12/18 A 60 W	5/5 A 60 W
	QKA	8/16 A 20 W					8/12 A 40 W	

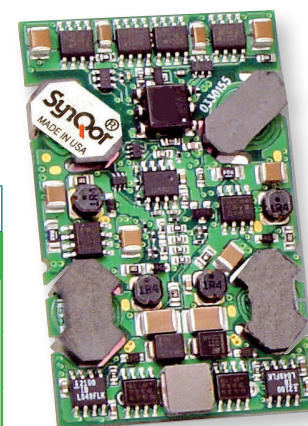

BusQor®

Isolated Bus Converters



High Efficiency Next Generation DC-DC Bus Converters

The BusQor® bus converters are the next-generation, board-mountable, isolated, fixed switching frequency DC-DC converters that uses synchronous rectification to achieve extremely high conversion efficiency. The power dissipated by the converter is so low that a heatsink is not required, which saves cost, weight, height, and application effort. BusQor converters are ideal for creating the mid-bus voltage required to drive point-of-load (non-isolated) converters in Intermediate Bus Architecture.

Operational Features

- Ultra-high efficiency up to 97%
- Wide input voltage ranges:
 - 42 V - 53 V (BQ50)
 - 35 V - 55 V (BQ55)
 - 40 V - 65 V (BQ57)
 - 35 V - 75 V (BQ60, PQ60)
 - 36 V - 75 V (SQ60)
 - 330 V - 365 V (BQ352)
 - 230 V - 400 V (BQ4H)
- Delivers 6.0 V, 9.6 V, 12 V, 13.6 V or 48 V bus for Intermediate Bus Architectures (IBA)
- Operating Temperature -40 °C to +100 °C
- Output Voltage Ripple <0.3% of Vout (typ.) pk-pk
- Input Ref. Ripple Current <5% of Iin (typ.) rms
- Current Share Accuracy ±10%
- Isolation Voltage Up to 4250 Vdc
- Industry standard pin-out configurations and standard footprints

Protection/Control Features

- Input under-voltage lockout (UVLO)
- Output current limit (OCP) and short circuit protection
- Output over-voltage protection (OVP)
- Thermal shutdown (OTP)
- Back-drive protection (starts into pre-biased load)
- On/Off control referenced to input side
- Remote sense
- Output voltage trim on select models

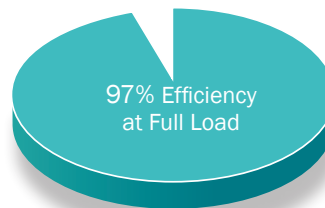

BusQor Isolated DC-DC Bus Converters

Family	Cont. Input Voltage	Output Voltage	Package Size	Performance Series	Thermal Design	Max. Output Current	Option Descriptions		
							Enable Logic	Pin Length	Feature Set
BQ SQ	50: 42-53 V 55: 35-55 V 57: 40-65 V 60: 35-75 V 352: 330-365 V 4H: 230-400 V	060: 6.0 V 090: 9.6 V 105: 10.5 V 120: 12.0 V 136: 13.6 V 480: 48.0 V 11: 11 V	E: Eighth Brick Q: Quarter Brick H: Half Brick F: Full Brick	T: Tera P: Peta E: Exa Z: Zeta Y: Yotta	A: Open frame B: Baseplate C: Encased D: Encased, Non-threaded Baseplate L: Low profile M: Low Profile, Baseplate V: Encased, Flanged Baseplate	17: 17 A 20: 20 A 25: 25 A 30: 30 A 40: 40 A 60: 60 A 87: 87 A <i>(not all models are shown)</i>	P: Pos. N: Neg.	K: 0.110" N: 0.145" R: 0.180" Y: 0.250"	S: Standard

Example: BQ4H480FTC64NNS-G For valid part numbers, refer to the website or contact your local sales representative or distributor.

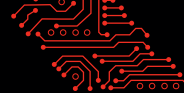

Input Voltage Range	UN-REGULATED		SEMI-REGULATED		FULLY-REGULATED	
	Model	Input Range / Max. Power / Efficiency	Model	Input Range / Max. Power / Efficiency	Model	Input Range / Max. Power / Efficiency
35 V						
42 V	BQ50 Input Range: 42-53 V Max. Power: 331 W Efficiency: 96%	BQ55 Input Range: 35-55 V Max. Power: 800 W Efficiency: 97%	BQ57 Input Range: 40-65 V Max. Power: 1050 W Efficiency: 97%	SQ60 Input Range: 36-75 V Transient: 100 V Max. Power: 600 W Efficiency: 95%	BQ60 and PQ60 Input Range: 35-75 V Transient: 100 V Max. Power: 600 W Efficiency: 95%	
55 V						
100 V						
230						
400 V	BQ352 Input Range: 330-365 V Transient: 450 V Max. Power: 600 W Efficiency: 95%	BQ4H Input Range: 230-400 V Transient: 450 V Max. Power: 3040 W Efficiency: 97%				

BQ55			
	Vout	9.6 V	12 V
48 Vdc Input (35-55 Vdc Input Range)			
Quarter Brick	QZB	84 A	67 A
	QEx	60 A	50 A
	QPA	43 A	
	QTA	240 W**	
Eighth Brick	EZB	48 A	38 A
	ETx	27 A	20 A
	ETL		16 A

SQ60			
	Vout	6 V	12 V
48 Vdc Input (36-75 Vdc Input Range, Transient 100 Vdc)			
Half Brick	HZx		50 A 600 W
Quarter Brick	QZB		40 A 480 W
	QPB		33 A 396 W
	QPx	55 A 330 W	28 A 336 W
	QEx		25 A 300 W
Eighth Brick	EPB		25 A 300 W
	ETA		20 A 240 W
	ETA		17 A 204 W

BQ60/PQ60		
	Vout	12 V
48 Vdc Input (35-75 Vdc Input Range, Transient 100 Vdc)		
Half Brick	HZx	50 A 600 W
	HEX	30 A 360 W
Quarter Brick	QZB	33 A 400 W
	QEx	25 A 300 W
	QEx	17 A 204 W

** BQ55090QTA27 is power limited @ 240 W over Input Voltage Range 36-55 Vdc

BQ50		
	Vout	12 V
48 Vdc Input (42-53 Vdc Input Range)		
Quarter Brick	QTA	20 A
	QTA	25 A

BQ57				
	Vout	9 V	10.5 V	12 V
48 Vdc Input (40-65 Vdc Input Range)				
Quarter Brick	QYB			84 A
	QZB	84 A		67 A
	QEx		60 A	50 A
Eighth Brick	EZB	48 A		38 A

BQ352		
	Vout	11 V
352 Vdc Input (330-365 Vdc Input Range, Transient 450 Vdc)		
Extended Eighth Brick	EEC	60 A 600 W

BQ4H			
	Vout	13.6 V	48 V
385 Vdc Input (230-400 Vdc Input Range, Transient 155-450 Vdc)			
Half Brick	HTC	80 A 1048 W	
Extended Eighth Brick	EEC	45 A 589.5 W	
Full Brick	FTC		64 A 3040 W

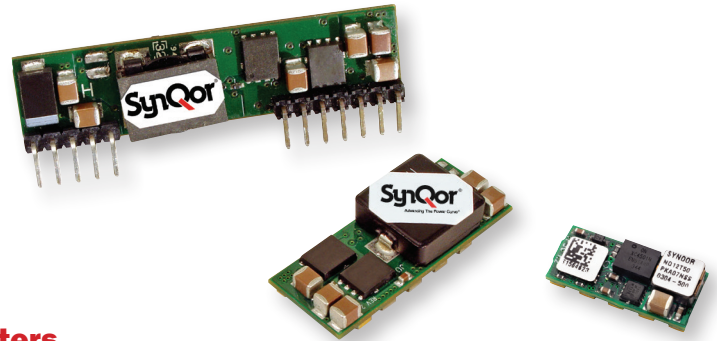

Non-Isolated, Ultra-High Efficiency DC-DC Converters for Telecom, Industrial and Medical Applications

The NiQor[®] DC-DC converter is a non-isolated buck regulator, which employs synchronous rectification to achieve extremely high conversion efficiency. The NiQor family of converters are used predominately in DPA systems using a front end DC-DC high power brick (48 Vin to low voltage bus). The non-isolated NiQor converters are then used at the point of load to create the low voltage outputs required by the design. The wide trim module can be programmed to a variety of output voltages through the use of a single external resistor.

General Specifications

- Operating Temperature -40 °C to +100 °C
- Output Voltage Set Point ±0.7 - 2.0%
- Output Voltage Ripple <1.5% of Vout (typ.) pk-pk
- Input Ref. Ripple Current <5% of Iin (typ.) rms
- Switching Frequency 300 - 390 kHz
- Industry standard pin-out configurations and standard footprints

Protection/Control Features

- Input under-voltage lockout (UVLO)
- Output current limit (OCP) and short circuit protection
- Output over-voltage protection (OVP)
- Thermal shutdown (OTP)
- On/Off control referenced to input side
- Output voltage trim (industry std. trim equations)

Operational Features

- Ultra-high efficiency up to 96%
- Wide input voltage ranges:
 - 2.4-6.0 Vin (NQ04W33 SMT) 0.75-3.6 Vout @ 10 A/16 A
 - 3.0-6.0 Vin (NQ04W33 SIP) 0.75-3.6 Vout @ 10 A/16 A
 - 3.0-5.5 Vin (NQ04T33 SIP) 0.9-3.3 Vout @ 10 A/16 A
 - 6.0-15 Vin (NQ15 W50 SMT) 0.8-5.0 Vout @ 30 A
 - 6.0-16 Vin (NQ16W50 SIP) 0.75-5.0 Vout @ 10 A/16 A
 - 6.0-16 Vin (NQ16W50 SMT) 0.75-5.0 Vout @ 10 A/16 A
- Wide Trimmable Output Voltage Ranges:
 - 0.75-5.0 V (W50)
 - 0.75-3.6 V (W33)
 - 0.9-3.3 V (T33)
- Output Voltage Trim Range: 0.7 - 5.5 V
- Suitable for use in Intermediate Bus Architectures
- On-board input and output filtering
- No minimum load requirement
- Optional features include remote sense, wide output voltage trim, and output current sharing
- Follows DOSA standard pinout and footprint

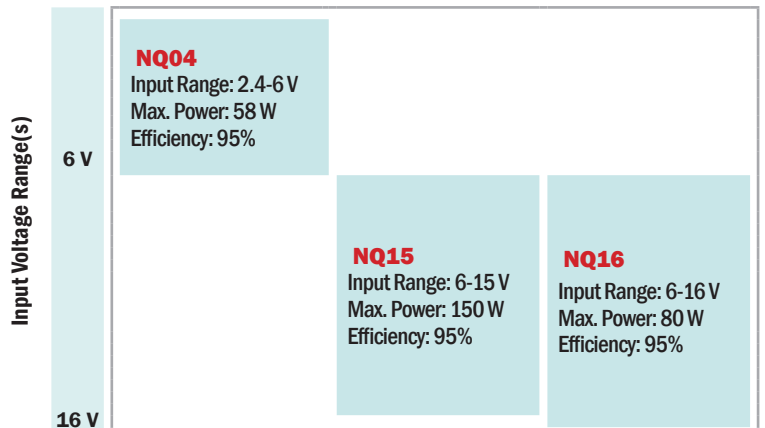

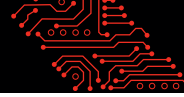

NiQor® listed by Package & Output Voltage

NQ04	Package	0.75-3.6 V	0.9-3.3 V
3.3, 5.0 Vdc Input			
2.4-6.0 Vin	SMT	10 A 36 W	
		16 A 58 W	
3.0-5.5 Vin	SIP		10 A 36 W
			16 A 58 W
3.0-6.0 Vin	SIP	10 A 36 W	
		16 A 58 W	

NQ15, NQ16	Package	0.75-5.0 V	0.8-5.0 V
12 Vdc Input			
6.0-15 Vin	SMT		30 A 150 W
6.0-16 Vin	SIP	10 A 50 W	
		16 A 80 W	
	SMT	10 A 50 W	
		16 A 80 W	

NiQor Non-isolated DC-DC Converter

Family	Input Voltage	Output Voltage	Package Type	Series	Thermal Design	Maximum Current	Options Description		
							Enable Logic	Pin Style	Feature Set
NQ	04: 2.4-6 V 15: 6-15 V 16: 6-16 V	W50: 0.75-5 V W33: 0.75-3.6 V T33: 0.9-3.3 V	V: Vert. SIP H: Horiz. SIP S: Surface-Mount	K: Kilo M: Mega G: Giga	A: Open frame	07: 7 A 10: 10 A 15: 15 A 16: 16 A 30: 30 A	P: Pos./Open O: Neg./Open N: Negative	R: 0.160" SIP Std V: 0.160" Rev. Vert. S: SMT Std.	N: None S: Sense D: Sense & Share G: Sense, Share and Gnd Pins

Example: NQ15W50SGA30NNS-G For valid part numbers, refer to the website or contact your local sales representative or distributor.

NiQor products are available in SIP and SMT packages. SIP package options include vertical and horizontal mounting pins. See website for data sheets with more details.

Surface mount converter

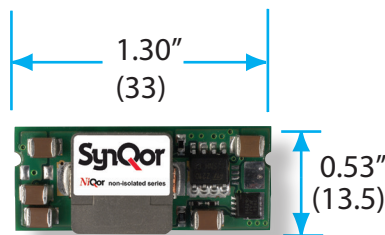

SIP converter

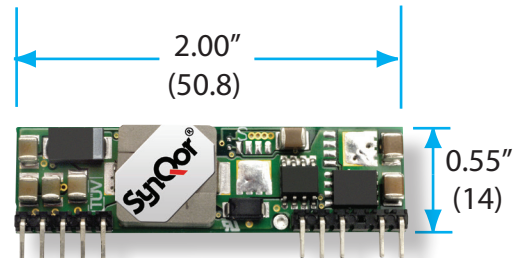

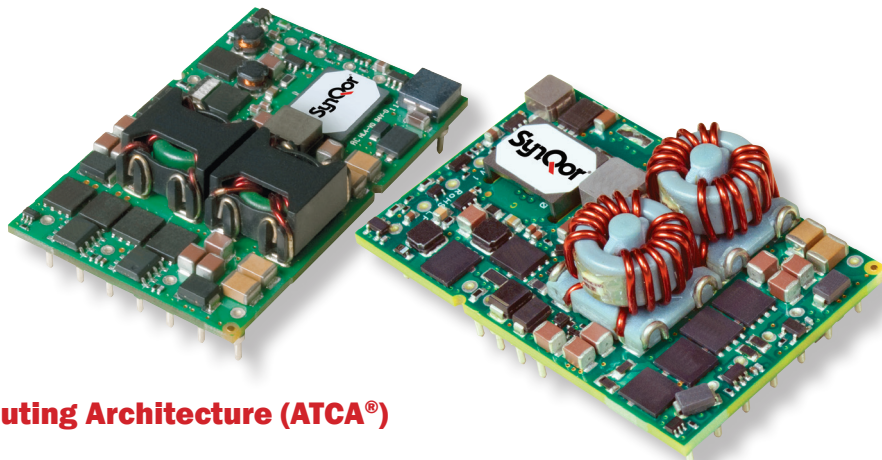

**Advanced Telecommunications Computing Architecture (ATCA®)
Power Interface Module**

The iQor Power Interface Modules integrate all features required by the Advanced TCA Base Specification for a frame board power entry into a Quarter-Brick footprint. Minimal external components are required for all the key functions. The product family provides efficient utilization of hold-up capacitance. A full-feature module with I²C interface is also available.

Operational Features

- 100 V/1ms transient protection
- Auxiliary supply voltages:
3.3 V, 3.6 A
5.0 V, 150 0mA

Standard Quarter Brick package size: 1.45" x 2.3"

- Trimmable 50-95 V hold-up capacitance voltage
- Optional I²C interface for feedback on:
A and B Feed Voltage
Hold-up Voltage
48 Vout Voltage and Current
Temperature
Fuse and MOSFET failure
- Random start-up delay
- -40 °C to +100 °C Operating Temperature
- Industry standard pin-out configurations and standard footprints

Protection/Control Features

- Inrush current limiting
- EMI filtering
- Output current limit (OCP) and short circuit protection
- Output over-voltage protection (OVP)
- Thermal shutdown (OTP)
- Hold-up capacitor discharge control

Threshold Protocols	Pin Length	Feature Set
S: Standard (ATCA) N: NEDS (Mega only) E: ETSI	K: 0.110" N: 0.145" R: 0.180" Y: 0.250"	S: Standard Feature F: Full Feature

iQor Power Interface Modules

Family	Input Voltage	Auxiliary Output 1	Auxiliary Output 2	Package Size	Performance Series	Thermal Design	Output Current	Threshold Protocols	Pin Length	Feature Set
IQ	6	50	33	Q	T: Tera M: Mega G: Giga	A	10 12 14	S	N	S

Example: **IQ6503QMA10SNS-G** For valid part numbers, refer to the website or contact your local sales representative or distributor.

iQor		
IQ65033QTA14	Power Interface Module	500 W ATCA Power Interface Module
IQ65033QGA12	Power Interface Module	350 W ATCA Power Interface Module
IQ65033QMA10	Power Interface Module	300 W ATCA Power Interface Module

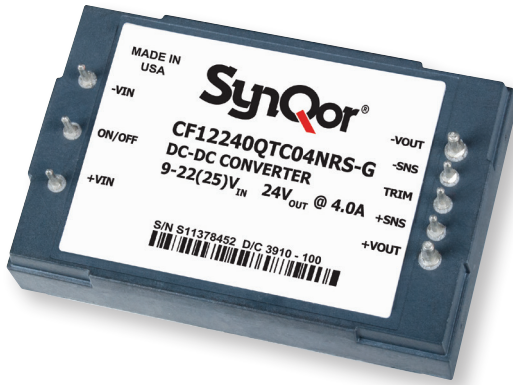
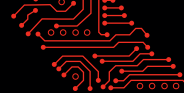

Medical Grade DC-DC Converters

Rated for CF Patient Contact and Defibrillation Proof

The CFQor series of Quarter-Brick DC-DC converters are high efficiency converters designed for those medical applications that require isolation and leakage current levels complying with IEC60601-1 for CF patient contact. They are also defibrillation proof.

Product Features

- High Efficiency, up to 93% at full rated load current
- Industry standard quarter-brick pin-out configuration
- Reinforced Insulation
- 4250 V, 100 mΩ input-to-output
- CF Patient Contact
- Defibrillation Proof
- -40 °C to +100 °C Operating Temperature
- Industry standard pin-out configurations and standard footprints

Output Voltage

CFQor	Series	Output Voltage			
		5 V	12 V	15 V	24 V
12 Vdc Nominal Input (9-22 V Continuous Input Range; 9-25 V transient)					
Quarter Brick	CF12	20 A 100 W	8 A 96 W	7 A 105 W	4 A 96 W
24 Vdc Nominal Input (18-36 V Continuous Input Range; 18-50 V transient)					
Quarter Brick	CF24	24 A 120 W	10 A 120 W	8 A 120 W	5 A 120 W
48 Vdc Nominal Input (34-75 V Continuous Input Range; 34-100 V transient)					
Quarter Brick	CF48	25 A 125 W	12 A 144 W	10 A 150 W	6 A 144 W

CFQor Medical Grade isolated DC-DC Converter

Family	Cont. Input Voltage	Output Voltage	Package Size	Series	Thermal Design	Maximum Output Current		Options Description		
								Enable Logic	Pin Length	Features
CF	12: 9-22 V 24: 18-36 V 48: 34-75 V	050: 5 V 120: 12 V 150: 15 V 240: 24 V	Q: Quarter Brick	T: Tera	C: Encased, Baseplate V: Encased, Flanged, Baseplate	25: 25 A 24: 24 A 20: 20 A 12: 12 A 10: 10 A	08: 8 A 07: 7 A 06: 6 A 05: 5 A 04: 4 A	N: Negative Logic	R: 0.180"	S: Standard

Example: CF24120QTC10NRS-G For valid part numbers, refer to the website or contact your local sales representative or distributor.



Medical Grade AC-DC Power Supplies

E-Series

G-Series



Medical Grade Highly Efficient AC-DC Power Supplies with PFC

The ACuQor® product line offers best-in-class solutions for AC-DC power supplies designed to meet an extensive range of medical applications. Packing 500 W of useable power into just 3.50" x 5.25" x 1.63", the E-Series is the world's smallest cardiac care, medical grade AC-DC converter for this power level. The G-Series provides 1400 W of useable power in a 4.75" x 7.00" x 1.63" package. The medical grade version meets 60601-1 medical safety specifications for cardiac contact without requiring an external isolation transformer.

Product Features

- High efficiency up to 93% at full rated load current
- Delivers up to 1400 W of output power (1800 W transient)
- Semi-regulated output
- Universal 85-264 V AC Input Voltage (47-63 Hz)
- Single output voltages: 12 V, 15 V, 24 V, 28 V, 36 V, 48 V
- 5 V "Always On" standby power output
- Over-current, over-voltage and over-temp protection
- DC Power Good and AC Power Good signals
- Remote enable input
- Type B, BF, CF & Defibrillator proof variants available
- Medical EMI Compatibility: IEC 60601-1-2 ed 4.0 compliant
- Active PFC; EN61000-3-2 compliant
- Low leakage; EN60601-1 compliant
- Low noise; EN55011 / EN55022 Class B compliant
- Operating ambient temperature: 0 °C - 70 °C

ACuQor Medical Grade AC-DC Power Supplies

Family	Output Power	Grade	Range	Output Voltage	Package Size	Thermal Design	Options
AQ	0300: 300 W 0400: 400 W 0500: 500 W 0800: 800 W 1100: 1100 W 1400: 1400 W	M: Medical	4: 4 th Generation EMC Universal (85-264 Vrms)	12: 12 V 1T: 12 V/12 V/5 V 15: 15 V 24: 24 V 2T: 24 V/12 V/5 V 28: 28 V 36: 36 V 3T: 36 V/12 V/5 V 48: 48 V 4T: 48 V/12 V/5 V	E: 1 Unit 3" x 5" G: 1 Unit 4.75" x 7"	A: Open-frame C: Encased	Medical Grade B: B isolation rating BF: BF isolation rating CF: CF isolation rating CFD: CF isolation rating, defibrillator proof

Example: AQ0400MU24ECBF For valid part numbers, refer to the website or contact your local sales representative or distributor.

Output Voltage	Power Rating		
G-Series (Single Output) (4.75" x 7.00" x 1.63" Encased Package) 12 V, 15 V, 24 V, 28 V, 48 V (includes 5 V @ 100mA standby)	800 W (1000 W Transient)	1100 W (1300 W Transient)	1400 W (1800 W Transient)
E-Series (Single Output) (3.00" x 5.00" x 1.46" Open Frame Package) (3.50" x 5.25" x 1.63" Encased Package) 12 V, 24 V, 36 V or 48 V (includes 5 V @ 50mA standby)	300 W (400 W Transient)	400 W (500 W Transient)	500 W (700 W Transient)
E-Series (Triple Output) (3.00" x 5.00" x 1.46" Open Frame Package) (3.50" x 5.25" x 1.63" Encased Package) 12 V, 24 V, 36 V or 48 V (includes 5 V @ 2 A & 12 V @ 4.2 A)	300 W (400 W Transient)	400 W (500 W Transient)	500 W (700 W Transient)



Open Frame Units



E-Series

The E-Series Products are available as encased and open frame units. Accessories, including input and output cables, are also available. See website for data sheets with more details.

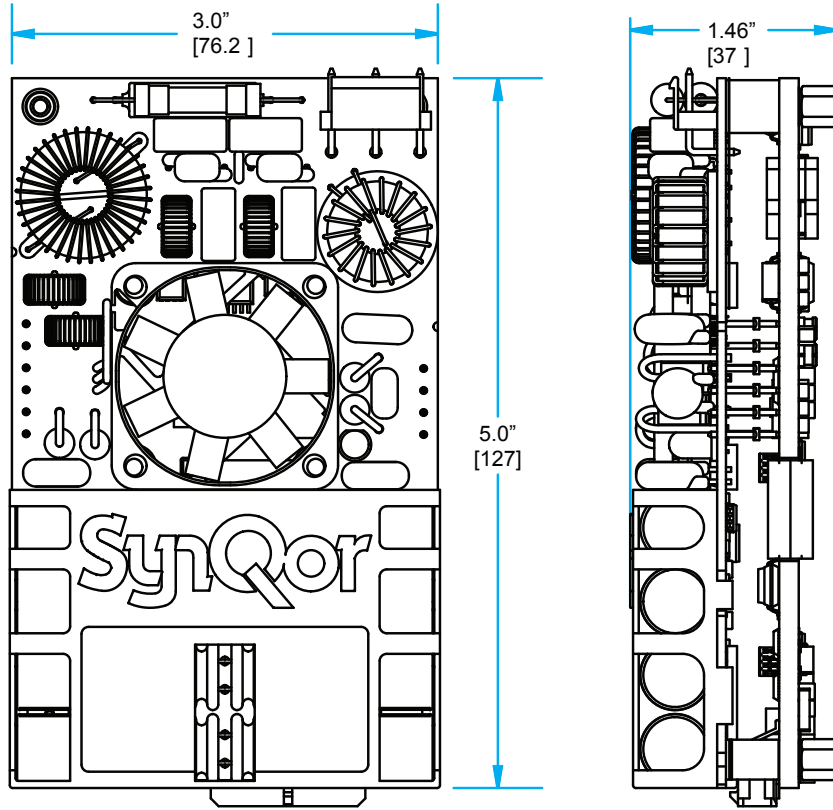

Encased Units

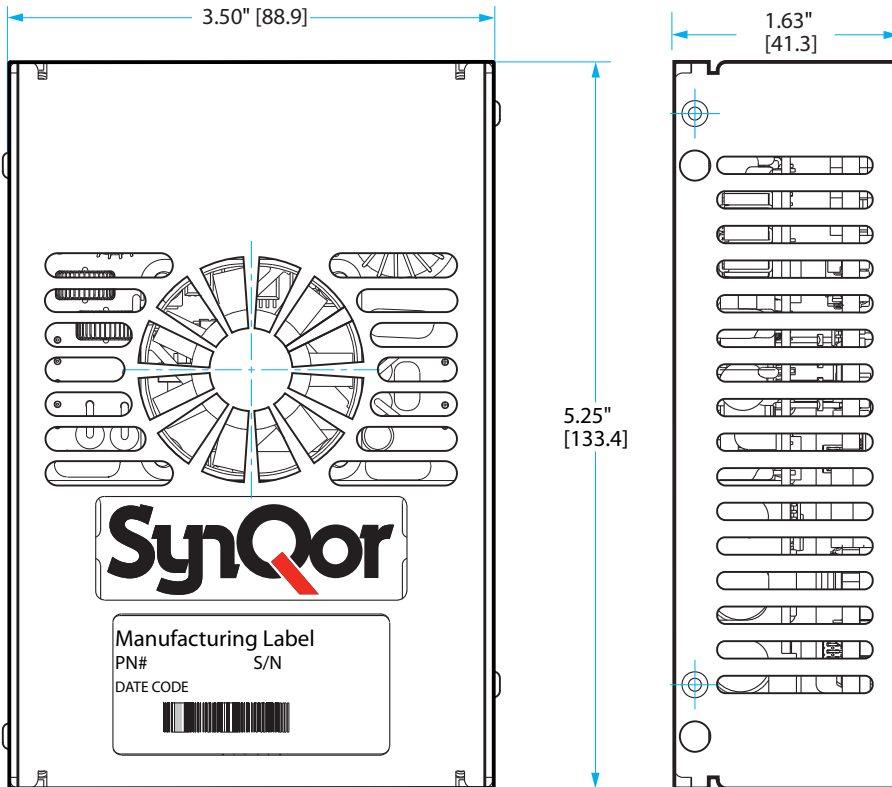

G-Series

The G-Series products are only available encased. Accessories, including input and output cables, are also available. See website for data sheets with more details.

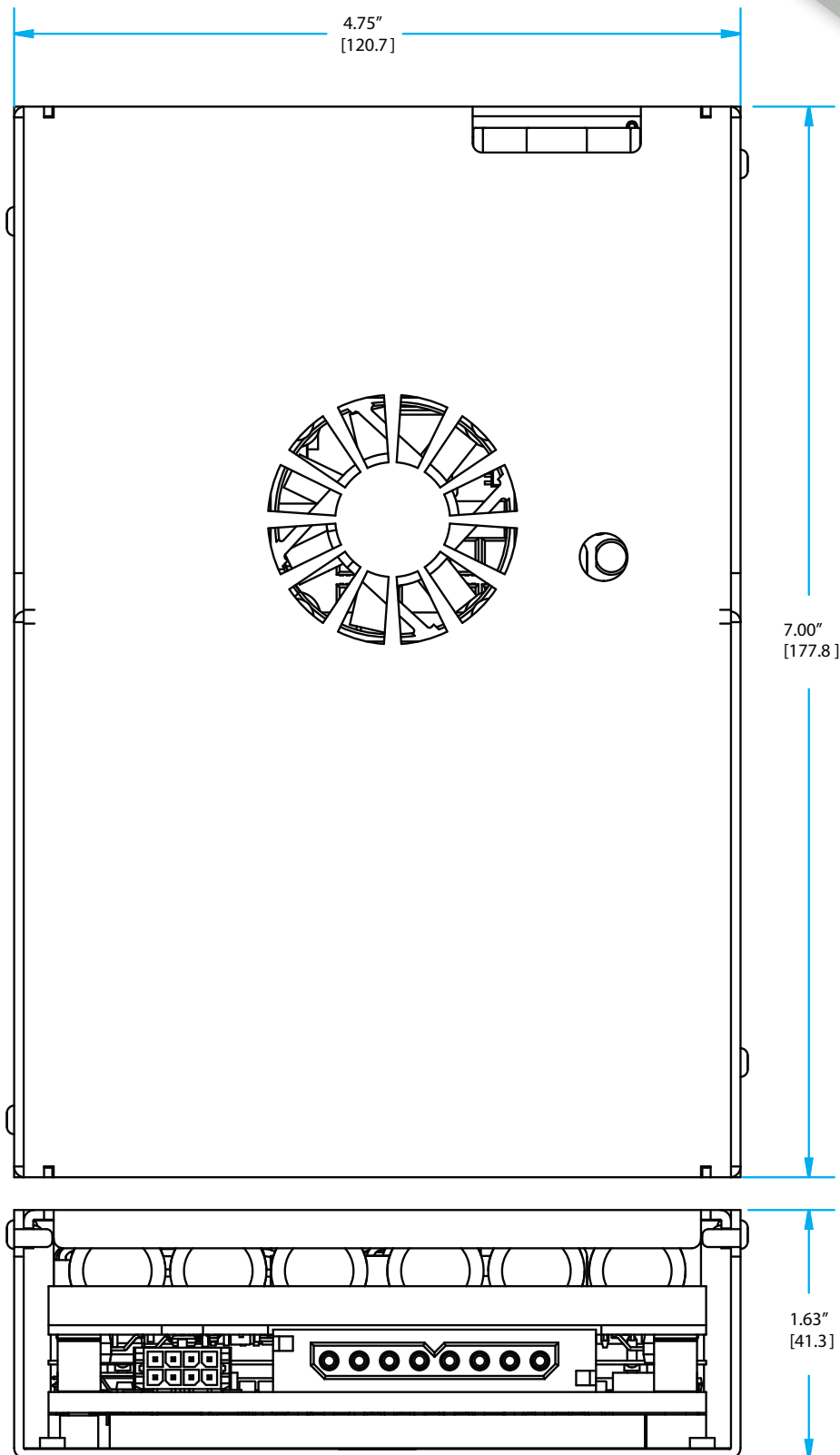



PowerQor, DualQor and BusQor

The open frame products are available in a variety of industry standard sizes/pinouts depending on power level and features. All units are available in open frame configurations as shown below. Many units are also available with varying configurations of base plates and mounting features. See website for data sheets with more details. All dimensions in inches (mm). See data sheets for heights.

Sixteenth Brick

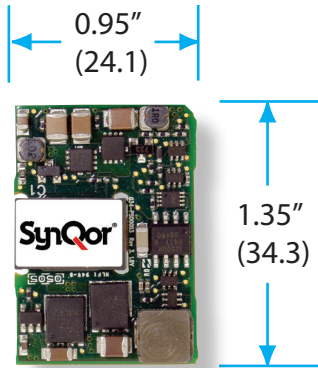

Eighth Brick

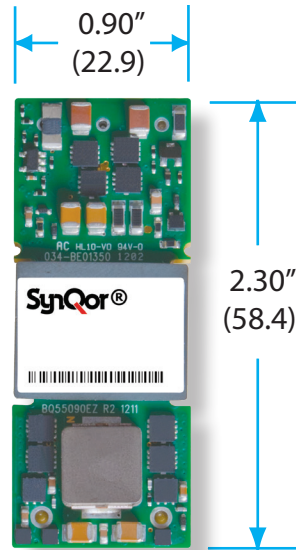

Half Brick

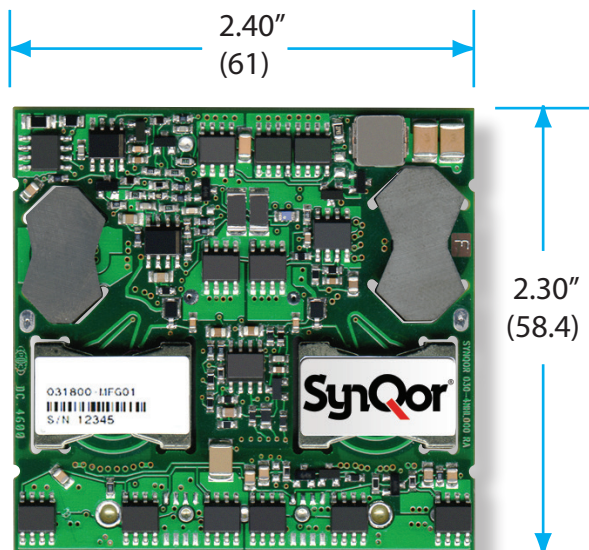

Quarter Brick

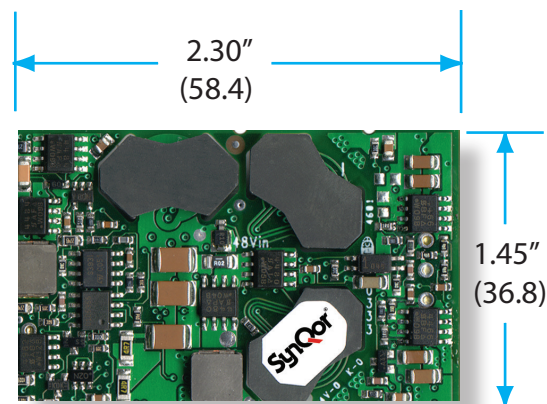

Mil-COTS, InQor, High Voltage NiQor, RailQor, AeroQor and CFQor

The fully encased products have additional environmental protection and are available in a variety of industry standard sizes/pinouts. There are various mounting configurations consisting of threaded inserts, through-hole inserts and mounting flanges. See website for data sheets with more details. All dimensions in inches (mm). See data sheets for heights.

Sixteenth Brick

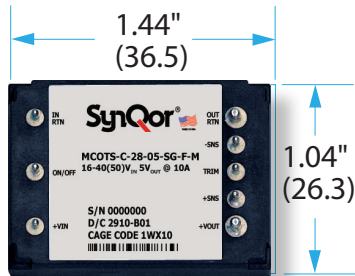

Eighth Brick



Quarter Brick

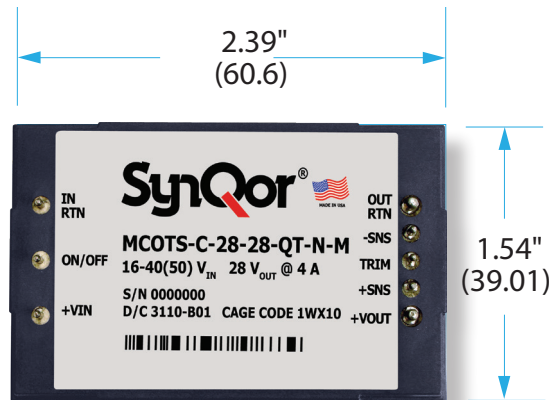

Flanged versions available. See the website for details



Demi Brick

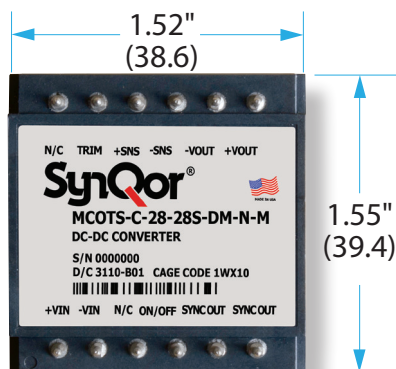

Quad Brick

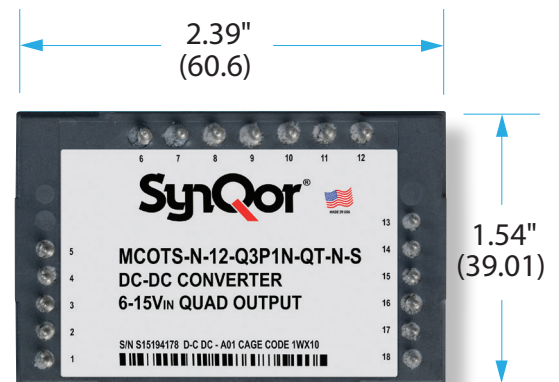



Half Brick

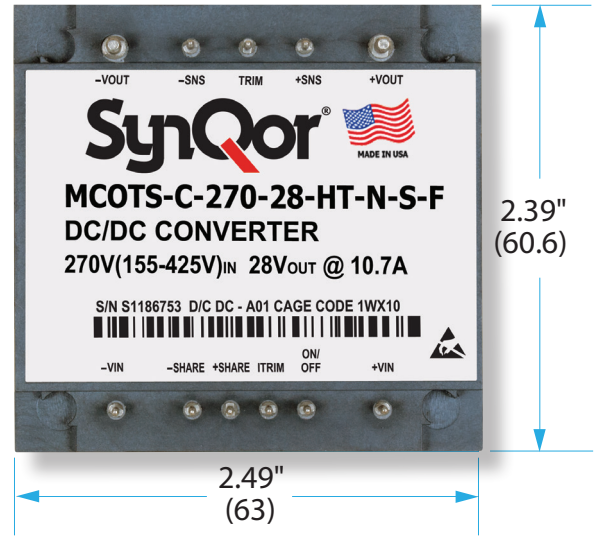
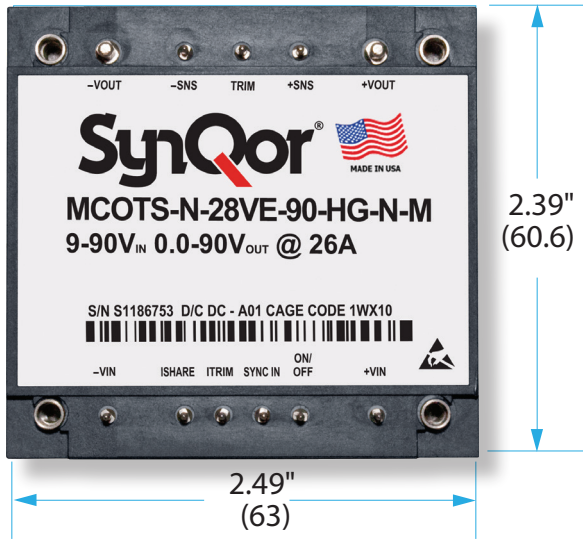

Full Brick

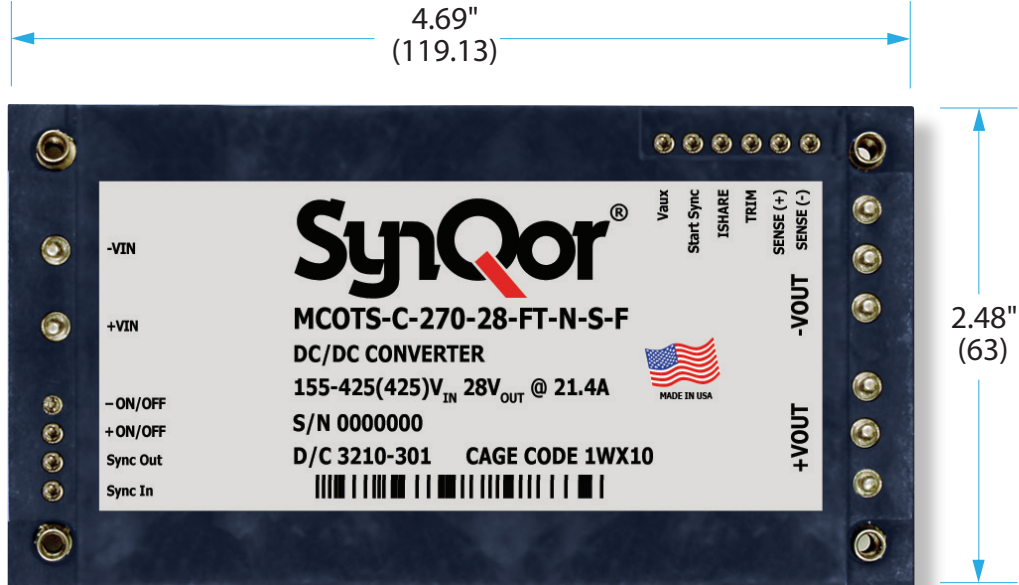

Hi-Rel

The High Reliability products are available in a variety of package mounting and lead form configurations. See website for data sheets with more details. All dimensions in inches [mm]. See data sheets for heights.

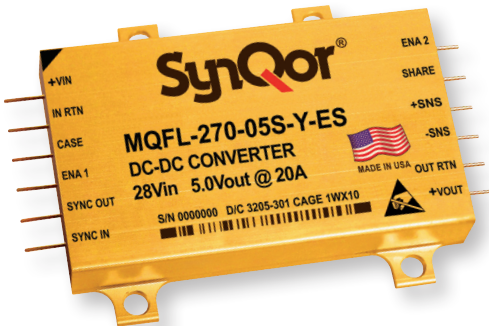

FL/ME Package

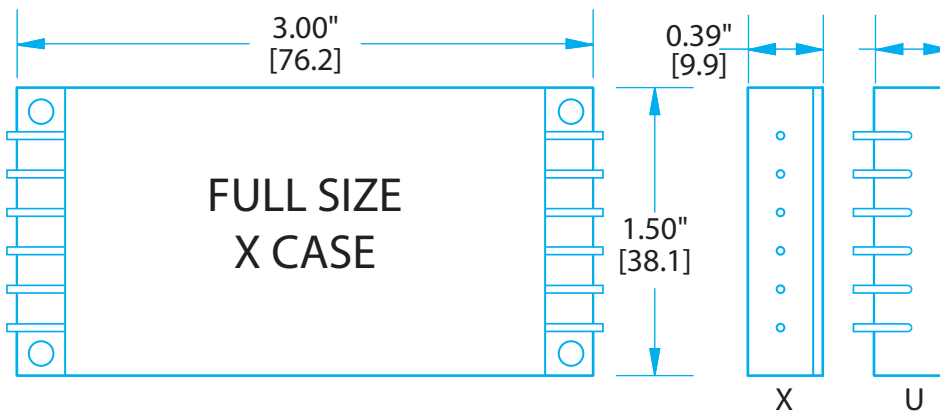
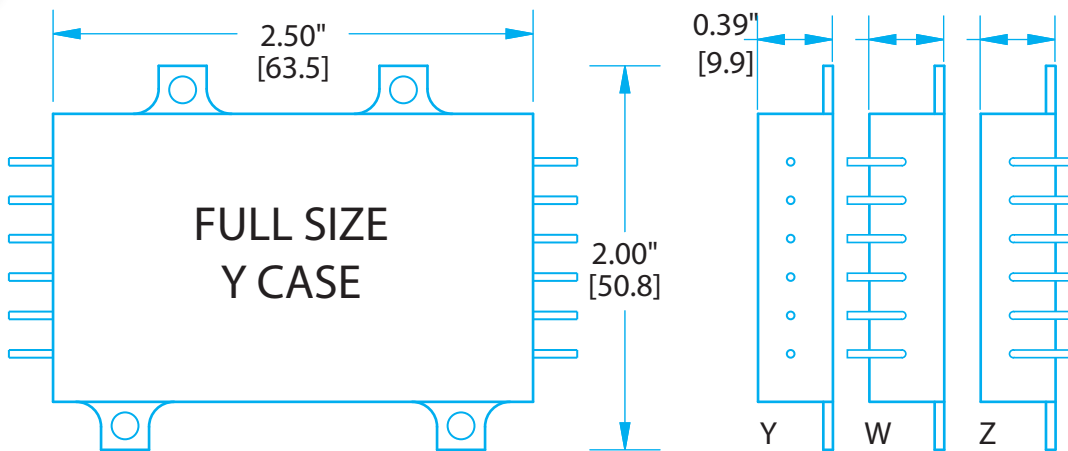



BL Package

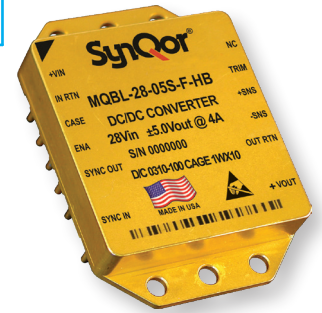
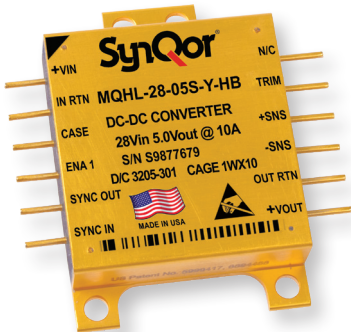
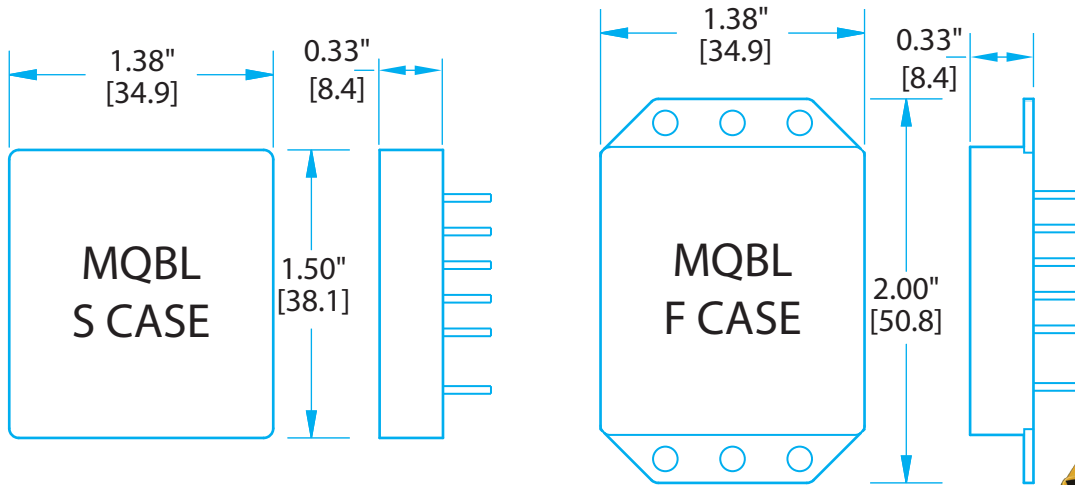

HL/HR/HE Package

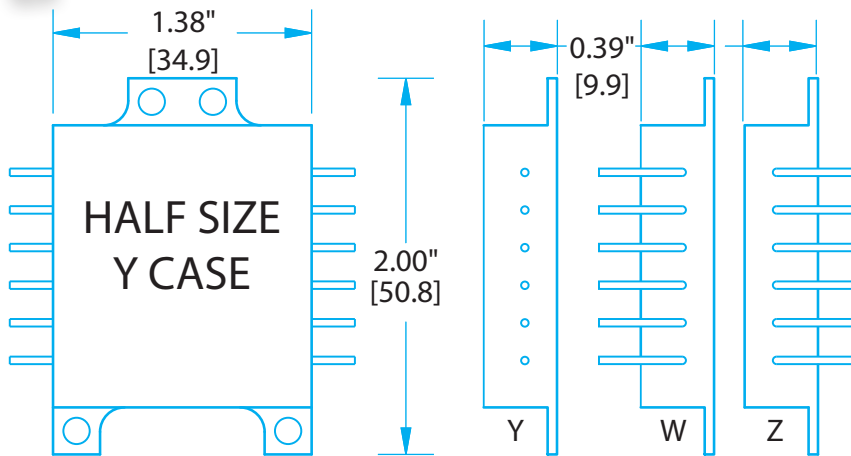

SA Package

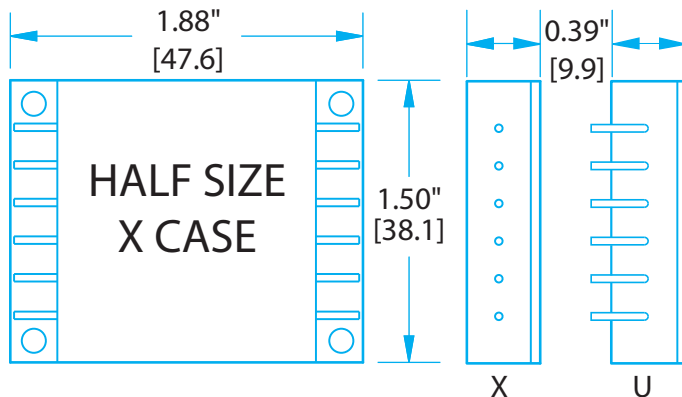
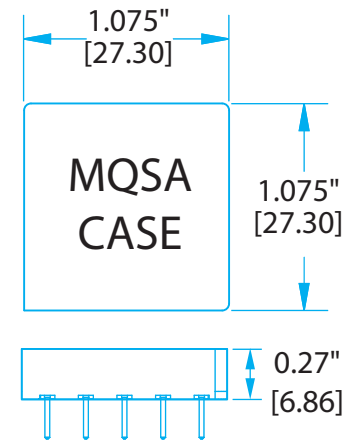

UPS Battery Packs

Model	BAT-0200-S-1U-000	BAT-0400-H-1U-000	BAT-0400-M-1U-000
Full Load Runtime	10	13.5	16
Weight	10 lbs.	11.8 lbs.	11.8 lbs.
1250/1500 S Series (1U)	1	1	1
1250/1500 S Series (2S)	1	1	1
3000 S Series (2U)	Uses 2	Uses 2	Uses 2

UPS/MPC Power Cables (10')

AC Input Connector	1250/1500 Series	3000 Series
NEMA 5-15P Plug	SYN-9104	
NEMA 5-20P Plug	SYN-9101	
Hardwire (2 AC lines + GND)	SYN-9102	SYN-9105
Hardwire (2 AC lines+GND+Connector Shell GND)	SYN-9108	
SCHUKO 16 A, 250 V-3W Euro Plug	SYN-9112	
UK 13 A 250 V Plug	SYN-9111	
MIL-C-26482 (Hardwire) 3-Phase UPS Only	SYN-9113	
AC Output Connector		
115 Vrms (NEMA 5-20R Receptacle)	SYN-9131	
Hardwire (2 AC lines + GND)	SYN-9130	SYN-9135
Hardwire (2 AC lines+GND+Connector Shell GND)	SYN-9138	
UK 13 A 250 V Sockets	SYN-9137	
DC Input Connector		
Ring Connectors	SYN-9151	
Hardwire	SYN-9152	SYN-9155
NATO Connector	SYN-9154	
DC Output Connector		
Fork Connectors	SYN-9171	
Hardwire	SYN-9172	SYN-9173
DC2/DC Output Only Fork #10	SYN-9175	
DC2/DC Output Only Hardwire	SYN-9174	SYN-9178

MPS/MPPS-4000 Power Cables

AC Input Connector	MPS/MPPS
AC Input 30 A, 10' (NEMA L18-30P)	SYN-9115
AC Input 30 A, 10' (Hardwire)	SYN-9116
DC Output Connector	
DC Output, 10', Negative (Hardwire)	SYN-9176
DC Output, 10', Positive (Hardwire)	SYN-9177
DC Output (MPS), DC Input (MINV, 28 V), 3', Negative	SYN-9180
DC Output (MPS), DC Input (MINV, 28 V), 3', Positive	SYN-9181

MINV Power Cables

AC Output	MINV
AC Output Single Phase, 10', (Hardwire)	SYN-9630
DC Input	
DC Input (MINV, 28 V) 10', Positive, (Hardwire)	SYN-9651
DC Input (MINV, 28 V) 10', Negative, (Hardwire)	SYN-9652
DC Input (MINV, 270 V) 10', Hardwire	SYN-9655
DC Output	
DC Output (MPS), DC Input (MINV, 28 V), 3', Negative	SYN-9180
DC Output (MPS), DC Input (MINV, 28 V), 3', Positive	SYN-9181

MAC Power Cables

AC Output	MAC
AC Output 10', (Hardwire)	SYN-9140
AC Input	
AC Input 10', (Hardwire)	SYN-9118

AC Output Power Strips

6 NEMA Receptacle Strip	1500 Series	3000 Series
1U Rackmount with 3' Cable	SYN-9231	
1U Rackmount with 3' Cable, with Breaker	SYN-9232	SYN-9236 ⁴

*Cable has Circular Connector



Multi-Unit Configuration Cables

Description	UPS	MPC	MPS	MPPS	MAC	MINV	CABLE
2 Units Parallel - 3'	•	•					SYN-9311
3 Units Parallel - 6'	•	•					SYN-9315
2 Units Series - 3'	•	•					SYN-9313
3 Units 3-Phase - 6'	•	•					SYN-9317
2 Units Series - 3'					•	•	SYN-9613
3 Units 3-Phase - 6'					•	•	SYN-9617
2 Units Parallel - 3'	•	•	•	•	•	•	SYN-9341
3 Units Parallel - 6'	•	•	•	•	•	•	SYN-9343
4 Units Parallel - 9'	•	•	•	•	•	•	SYN-9344
5 Units Parallel - 15'	•	•	•	•	•	•	SYN-9345



User I/O Cables

Description	UPS	MPC	MPS	MPPS	MAC	MINV	CABLE
HD DB15M to DB9F (RS232) - 10'	•	•	•	•	•	•	SYN-9301
HD DB15M to DB15M (RS232 and Digital I/O) - 10'	•	•	•	•	•	•	SYN-9305
MI-Circular to Sealed RJ45 (Ethernet) Network SNMP - 10'	•	•	•	•	•	•	SYN-9321





Rackmount Kits

KIT	1250/1500 S	1250/1500 2S	3000 S	MPC-1250 1S	MPPS/MPS	MINV-4000	MAC-4000
Slide Rail Kit ²	SYN-9002	SYN-9043	SYN-9002	SYN-9057	SYN-9002	SYN-9002	SYN-9002
Fixed Bracket ³	SYN-9031	SYN-9041	SYN-9033	SYN-9055	SYN-9038	SYN-9031	SYN-9031

Transit Cases

All Rack-mount Power Supplies	
Transit Case, 3U, Gray, with Casters ³	SYN-9410
Transit Case, 3U, Gray, No Casters ³	SYN-9412

Fan Replacement Kits

1500 2S	MPS/MPPS	MINV	MAC
SYN-9450	SYN-9450	SYN-9452	SYN-9452

Notes:

1. Other Accessories are also available -- for further information contact Power@SynQor.com
2. Slide Rail Kit (SYN-9002) is not recommended for transit and ruggedized use.
3. Fixed Bracket Kit (SYN-9031) with Transit Case (SYN-9410 or SYN-9412) is required for transit and ruggedized use (qualified to pass MIL-STD-810G Loose Cargo and Transit Drop requirements).
4. For UPS use with grounded output option only.
5. Not required for parallel operation.



MultiQor Plate Cables

These cables can be used with MultiQor Plates and Adaptor Boards with multiple output options to accommodate different levels of output current.

MultiQor Plate Cables	
Input mating cable with pre-stripped wire ends (36")	MTQ-CBL-INPUT1C
Input mating cable with pre-stripped wire ends (36"), no filter	MTQ-CBL-INPUT2C
Input mating cable with pre-stripped wire ends (36"), 10 AWG	MTQ-CBL-INPUT3C
Input mating cable with pre-stripped wire ends (36"), AC Holdup	MTQ-CBL-ACCAP1
Input mating cable with pre-stripped wire ends (36"), AC Signal	MTQ-CBL-ACINPUTS1
Input mating cable with pre-stripped wire ends (36"), AC Power	MTQ-CBL-ACINPUTP1
Output signal mating cable with pre-stripped wire ends (36")	MTQ-CBL-OUT1CS
Output mating cable (20 A) with pre-stripped wire ends (36")	MTQ-CBL-OUT1CP20
Output mating cable (40 A) with pre-stripped wire ends (36")	MTQ-CBL-OUT1CP40
Output mating cable (60 A) with pre-stripped wire ends (36")	MTQ-CBL-OUT1CP60



ACuQor Cables

The following documents are the mechanical drawings for a series of assemblies that SynQor offers for the customer's convenience.

ACuQor Cables	E-Series	G-Series
Input mating cable with pre-stripped wire ends (36")	AQ-CBL-INPUT1C	AQ-CBL-INPUT1CG
Output mating cable with pre-stripped wire ends (18")	AQ-CBL-OUT1C	AQ-CBL-OUT1CDG
Same as AQ-CBL-OUT1C with additional 8 pin connector (18")	AQ-CBL-OUT2C	
Output mating cable with connectors on both ends & additional 8 pin connector (18")	AQ-CBL-OUT2CD	
Single module bottom-side Mylar insulator for open frame mounting	AQ-INSUL1M	
Evaluation board for up to three paralleled modules	AQ-EVAL-PRL3	



Interface Adaptors

Our series of thru hole mounting adaptor boards allows for easy wiring to SynQor filters and DC-DC converters. For terminal and component assignments and additional information, please see our application note "Interface Adaptor Boards." The following documents contain mechanical information.

Adaptor Size	Single Output DC-DC Converters	DC-DC Converters Operating with SynQor Transient Filter	Dual Output DC-DC Converters	Passive Filters	Transient Suppression Filters	AC Line Filters	Power Factor Correctors	Isolated Power Factor Correctors
Sixteenth Brick	SBI-00	SBI-04						
Demi Brick	DBI-00		DBI-03	DBI-02				
Quarter Brick	QBI-00	QBI-04		QBI-02			QBI-03	
Half Brick	HBI-00	HBI-06		HBI-02	HBI-03	HBI-04	HBI-05	HBI-08
Full Brick	FBI-00 / 02							

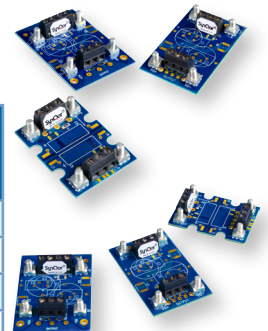

Integrates Business Processes & Enforces Process Adherence

Action Log						
TSN:	S8660420	Origin:	SynQor	Work Order:	Run031996	
Serial:	S8660420	Location:	PE DALLAS	Routing:	QualificationRouting	
Lot:	MQFL-270-05D-Y-HB/-1	DC:	3308	SMTAlias:	P905276	
Qty:	1	TSN Status:	Prototype	HIREStatus:	COMMERCIAL	
TSN	StepName	ActionPerformed	Station	DatePerfor	DetailName	
S8660420	NOP	To HRC	NONE	2008-08-13		
S8660420	Depanelization	Depanelization	ASYS_1	2008-08-13		
S8660420	Print Label	PrintLabel	NONE	2008-08-13		
S8660420	To CELL 1	To CELL 1	NONE	2008-08-13		
S8660420	Out of Batch Oven	EndBatchOven	NONE	2008-08-13		
S8660420	Into Batch Oven	StartBatchOven	NONE	2008-08-13		
S8660420	E-Core	E-Core	NONE	2008-08-13		
S8660420	To HRC	To HRC	NONE	2008-08-13		
S8660420	NOP	Process_Audit	NONE	2008-08-12		
S8660420	SMT	SMT	SM32	2008-08-12		
S8660420	SMT	SMT	SM31	2008-08-12		
S8660420	SMT	SMT	SM31	2008-08-12		
S8660420	SMT	SMT	SM32	2008-08-12		
S8660420	SMT	SMT	SM31	2008-08-12		
S8660420	NOP	Comment	NONE	2008-08-12		
S8660420	TSNentry	Recipe011178	MABXPR	2008-08-12		

WIP Table												
Production WIP Report												
Order No.	Order Date	Order Qty	Order Status	Order Type	Order Desc	Order Part	Order Qty	Order Date	Order Status	Order Type	Order Desc	Order Part
S8660420	2008-08-13	1	Open	Prototype	Prototype	S8660420	1	2008-08-13	Open	Prototype	Prototype	S8660420

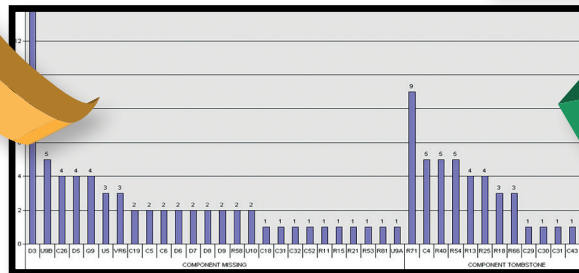
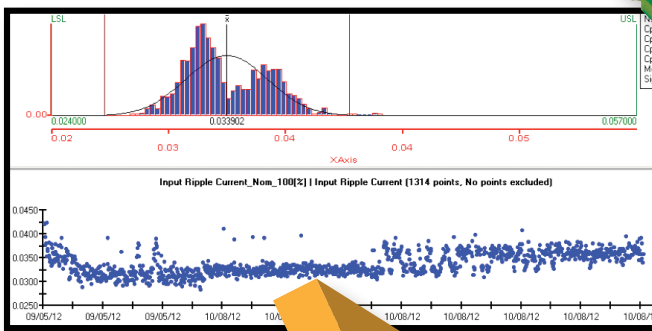
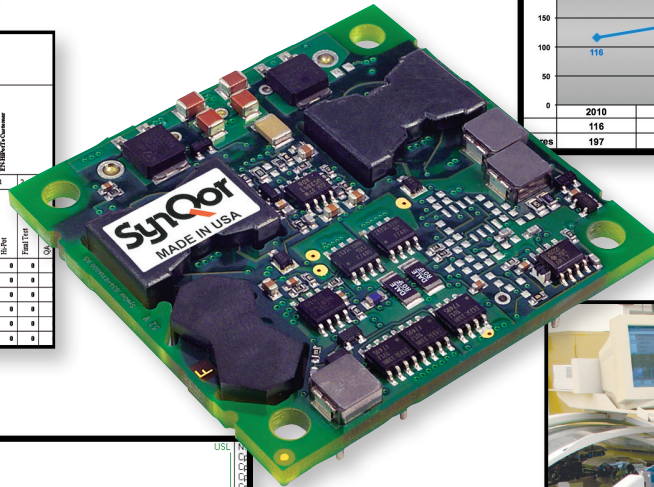
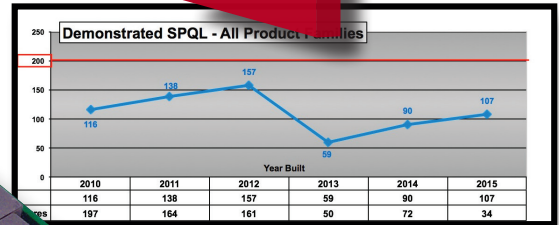



USA Manufacturing Facility: AS9100 & ISO-9001 Certified

SynQor considers in-house manufacturing to be a core competency and strategic advantage. All SynQor products are manufactured in our production facility at our corporate headquarters in Boxborough, MA, USA, utilizing state-of-the-art equipment and proprietary assembly techniques. By maintaining both AS9100 and ISO-9001 certifications, SynQor is able to provide the same level of attention to detail in our manufacturing processes as we do in our products. We utilize proprietary in-house developed manufacturing data and document control systems that allow us to operate in a paperless manufacturing environment, providing both maximized manufacturing efficiency and flexibility. Ultimately, our manufacturing expertise remains in-house, allowing us to maintain complete control over the quality and traceability of our product down to the component level to meet the most stringent customer and industry requirements.

Configuration Control

- Documentation Control
- Manufacturing Routings
- Design Drawings
- BOMs

Containment

- Stop Ship
- Process Diversions



Process Control

- Equipment
- Production Programs
- Temperature Profiles
- Process Times
- Test Parameters

Information Collection

- Unit History
- Component History
- Process Data Capture

Real-Time Reporting

- WIP
- Cycle Times
- Yields
- Material Flow

SynQor employs a stringent, ECO controlled, 5-stage product development process, starting with product concept design and ending with manufacturing integration. We believe that a solid design and DFM review process leads to efficient manufacturing, higher performance, and enhanced reliability. By designing for reliability, SynQor greatly reduces the chance of field defects and increases manufacture integrity.



Concept Design	Design & Verification	Proof of Design	Proof of Manufacturing	Manufacturing Integration
<ul style="list-style-type: none"> • Generate electrical specification • Review performance requirements • Design simulation • Schematic • Qualify new components • Breadboard • Prelim thermal analysis 	<ul style="list-style-type: none"> • Full layout • DFM/DFT Review • Build engineering prototypes • Debug circuit • Worst-case electrical testing • Component stress analysis • Stability analysis • Abnormal electrical testing • Specification review • Preliminary datasheet 	<ul style="list-style-type: none"> • Build units and electrically characterize • Verify electrical performance • Verify component stress analysis • Statistical variations • Thermal analysis and imaging • HALT testing • Complete datasheet 	<ul style="list-style-type: none"> • Controlled Production Build • ATE testing • Yield analysis • Validate and finalize manufacturing processes and Tooling • 1000 hour life test • Qualification testing (humidity, vibration, DMT, PTC, thermal and mechanical shock, altitude and solderability) 	<ul style="list-style-type: none"> • Processes transfer • Full documentation release (SCD's, BOM, processes, procedures, etc.) • Release qualification reports • Release final datasheet • Transfer units to finished goods

Automated Manufacturing Center

Our manufacturing facility has multiple production lines that are integrated into the plant resources. The engineering and design units are within seconds of the manufacturing areas. Component supply, production, testing and shipping areas of the Company are readily available to the design engineers to check performance under specific conditions which will not show up in the normal design characterization.

Designers are able to achieve more energy efficient robust products with an integrated design and manufacturing workflow.

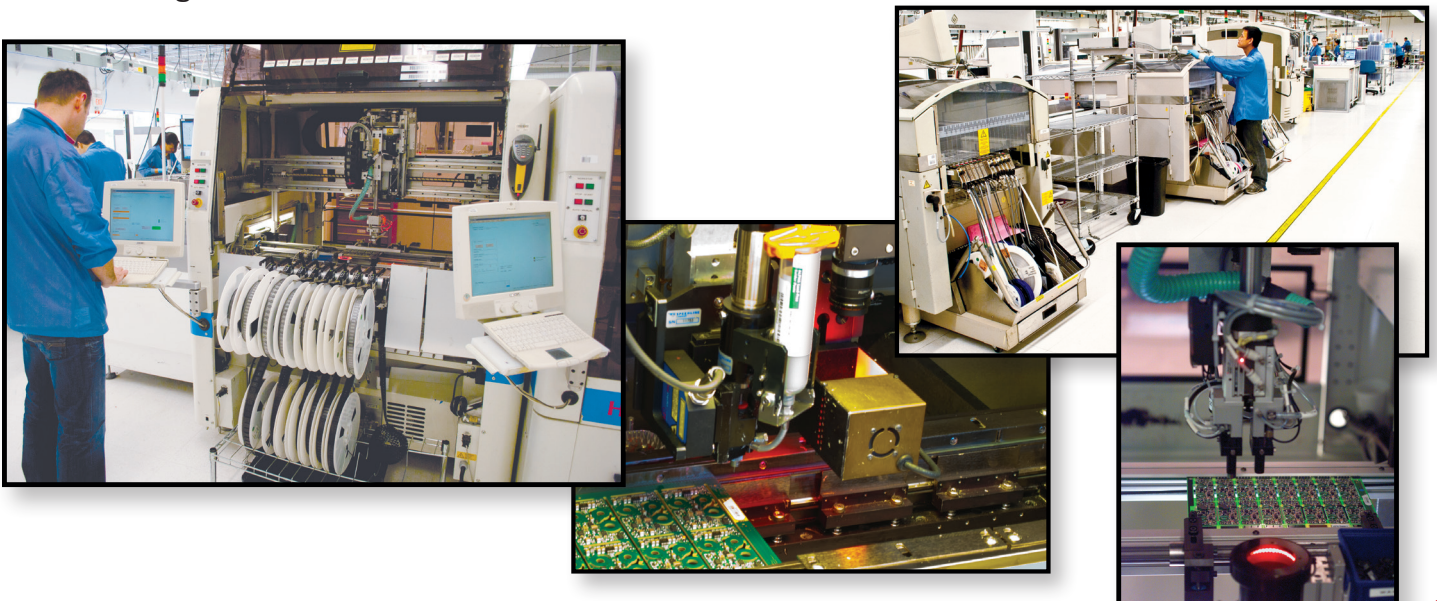



Military-Brick Center

SynQor's Military MilQor® Hi-Rel and MCOTS products are manufactured to IPC-A-610 Class III standards in the Military-Brick Center, a Class 10,000 capable clean room environment. Meticulous attention to detail by specially trained personnel, following exacting assembly and testing protocols that include Temperature Cycle, Extended Burn-In, -55 °C to +125 °C Functional Verification, and Constant Acceleration, manufacture products of the highest reliability to meet stringent MIL-STD requirements.



System Solutions

SynQor System-Level Products include Custom Hi-Rel Military, UPS (military/industrial), as well as ACuQor (medical) products. SynQor manufactured sub-assemblies are delivered to dedicated production areas for system final assembly, integration, and test for SynQor's System-Level products. System assembly and test capabilities include:

- THT (through-hole-technology) assembly and soldering to IPC-A-610 class II and class III standards.
- Mechanical sub-assembly integration and hardware installation.
- Wire harness installation and sub-assembly staking and potting.
- Sub-assembly Hi-Pot and Electrical Functional Test.
- System-level Leakage, Burn-In, and Electrical Functional Test.
- Final QA and Packaging.



Prototype Milling Machine Lab

Our manufacturing facility has made significant investments into our precision milling technology equipment. With increased capabilities, we are ready to meet even the most stringent quality and delivery requirements from any customer. Our full complement of precision components produced on our enhanced tool room equipment enables us to respond effectively and quickly to deliver prototypes to our customer's design specifications.

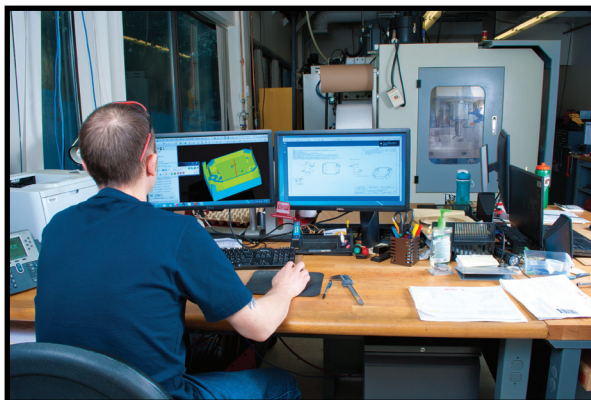
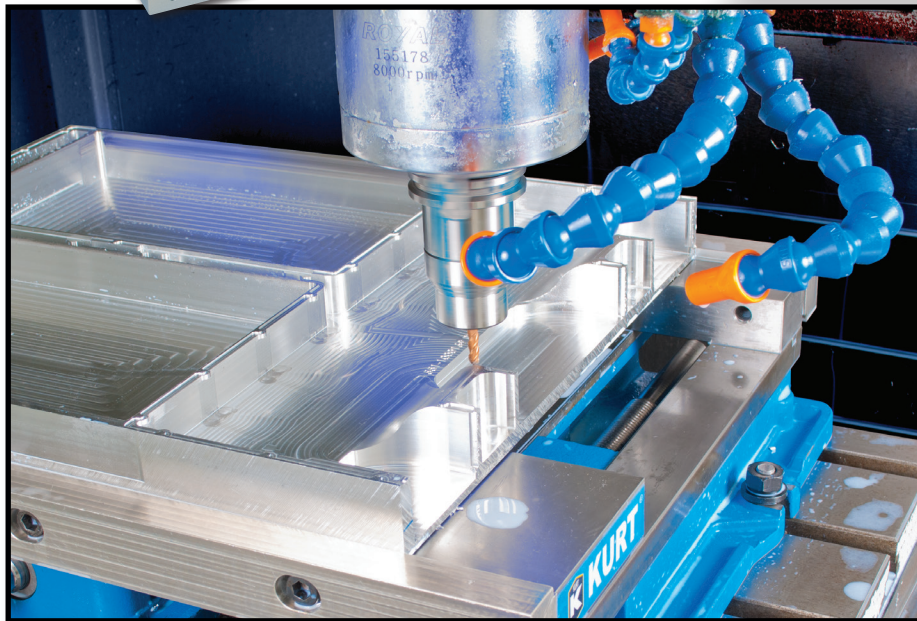
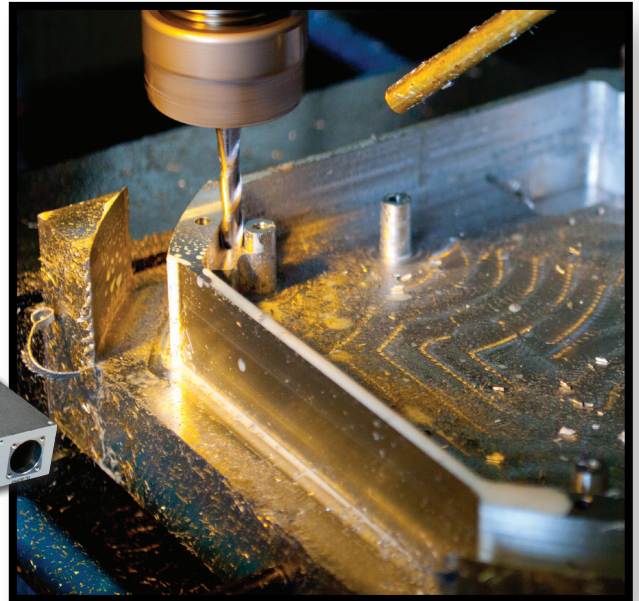







SynQor, Inc.

Toll Free (USA): 888-567-9596

E-mail: power@synqor.com

Phone: 978-849-0600

Fax: 978-849-0602

www.SynQor.com

Advancing the Power Curve®

SynQor is a leading supplier of power conversion solutions to the military, avionics, transportation, medical, industrial, telecommunications and computing markets. SynQor's innovative products are designed to exceed the demanding performance, quality, and reliability requirements of today's power electronic engineers who develop leading-edge infrastructure hardware. SynQor provides all the power conversion modules needed to build a power system, and it also provides complete power systems. SynQor's capabilities include both standard and custom solutions, and it delivers them with industry leading service and support. SynQor's total commitment to quality, customer satisfaction and continuous improvement drives our business processes. SynQor is headquartered in Boxborough, MA with an additional design facility in Plano, TX, USA.

Power Converters & Systems