

# SynQor®

## MQFL-28-28S Single Output

### HIGH RELIABILITY DC/DC CONVERTER

<b>16-40V</b> Continuous Input	<b>16-50V</b> Transient Input	<b>28.0V</b> Output	<b>4A</b> Output	<b>91% @ 2A / 88% @ 4A</b> Efficiency
-----------------------------------	----------------------------------	------------------------	---------------------	--

**FULL POWER OPERATION: -55°C TO +125°C**

The MilQor® series of high-reliability DC/DC converters brings SynQor's field proven high-efficiency synchronous rectifier technology to the Military/Aerospace industry. SynQor's innovative QorSeal™ packaging approach ensures survivability in the most hostile environments. Compatible with the industry standard format, these converters operate at a fixed frequency, have no opto-isolators, and follow conservative component derating guidelines. They are designed and manufactured to comply with a wide range of military standards.

# MilQor®



DESIGNED & MANUFACTURED IN THE USA  
FEATURING QORSEAL™ HI-REL ASSEMBLY

#### Design Process

MQFL series converters are:

- Designed for reliability per NAVSO-P3641-A guidelines
- Designed with components derated per:
  - MIL-HDBK-1547A
  - NAVSO P-3641A

#### Qualification Process

MQFL series converters are qualified to:

- MIL-STD-810F
  - consistent with RTCA/DO-160E
- SynQor's First Article Qualification
  - consistent with MIL-STD-883F
- SynQor's Long-Term Storage Survivability Qualification
- SynQor's on-going life test

#### In-Line Manufacturing Process

- AS9100 and ISO 9001:2000 certified facility
- Full component traceability
- Temperature cycling
- Constant acceleration
- 24, 96, 160 hour burn-in
- Three level temperature screening

#### Features

- Fixed switching frequency
- No opto-isolators
- Parallel operation with current share
- Remote sense
- Clock synchronization
- Primary and secondary referenced enable
- Continuous short circuit and overload protection
- Input under-voltage lockout/over-voltage shutdown

#### Specification Compliance

MQFL series converters (with MQME filter) are designed to meet:

- MIL-HDBK-704-8 (A through F)
- RTCA/DO-160E Section 16
- MIL-STD-1275B
- DEF-STAN 61-5 (part 6)/5
- MIL-STD-461 (C, D, E)
- RTCA/DO-160E Section 22

### BLOCK DIAGRAM

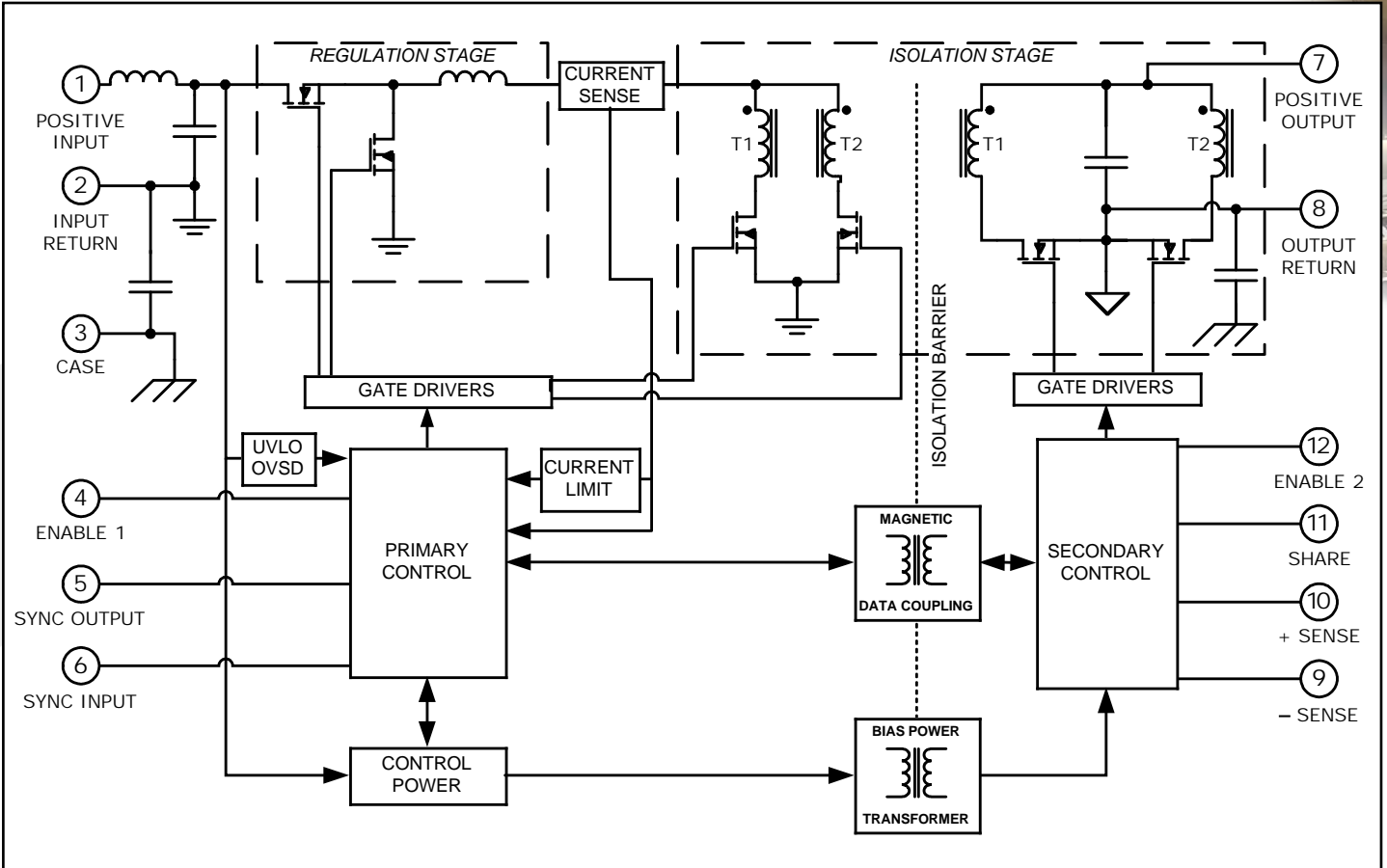

### TYPICAL CONNECTION DIAGRAM

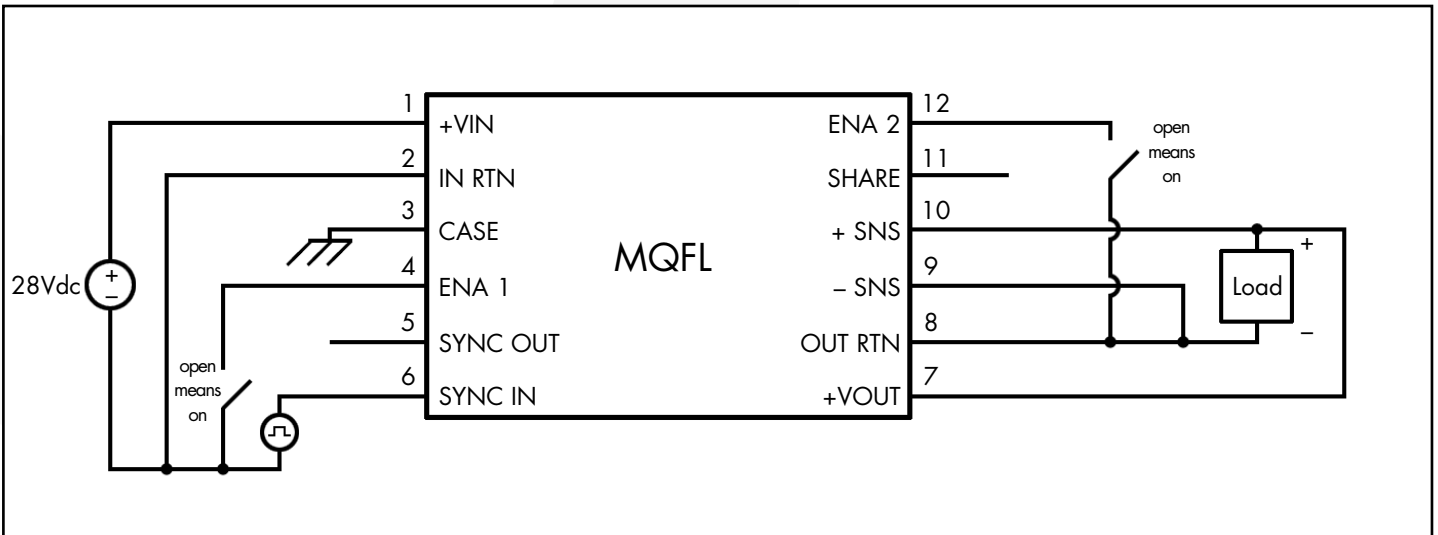



**MQFL-28-28S**  
**Output: 28.0 V**  
**Current: 4 A**

# Technical Specification

## MQFL-28-28S ELECTRICAL CHARACTERISTICS

Parameter	Min.	Nom.	Max.	Units	Notes & Conditions Vin=28V DC ±5%, Iout = 4A, CL = 0 µF, free running <sup>10</sup> unless otherwise specified	Group A Subgroup <sup>13</sup>
<b>ABSOLUTE MAXIMUM RATINGS</b>						
Input Voltage						
Non-Operating			60	V		
Operating <sup>1</sup>			60	V		
Reverse Bias (T <sub>CASE</sub> = 125°C)			-0.8	V		
Reverse Bias (T <sub>CASE</sub> = -55°C)			-1.2	V		
Isolation Voltage (input/output to case, input to output)						
Continuous	-500		500	V		
Transient (≤100 µs)	-800		800	V		
Operating Case Temperature <sup>2</sup>	-55		135	°C		
Storage Case Temperature	-65		135	°C		
Lead Temperature (20 sec)			300	°C		
Voltage at ENA1, ENA2, SYNC IN	-1.2		50	V		
<b>INPUT CHARACTERISTICS</b>						
Operating Input Voltage Range (continuous)	16	28	40	V		1, 2, 3
Operating Input Voltage Range (transient, 1 sec)	16	28	50	V		4, 5, 6
Input Under-Voltage Lockout <sup>3</sup>						
Turn-On Voltage Threshold	14.75	15.50	16.00	V		1, 2, 3
Turn-Off Voltage Threshold	13.80	14.40	15.00	V		1, 2, 3
Lockout Voltage Hysteresis	0.50	1.10	1.80	V		1, 2, 3
Input Over-Voltage Shutdown <sup>3</sup>						
Turn-Off Voltage Threshold	54.0	56.8	60.0	V		1, 2, 3
Turn-On Voltage Threshold	50.0	51.4	54.0	V		1, 2, 3
Shutdown Voltage Hysteresis	2.0	5.3	8.0	V		1, 2, 3
Maximum Input Current						
No Load Input Current (operating)		110	160	mA	Vin = 16V; Iout = 4A	1, 2, 3
Disabled Input Current (ENA1)		2	5	mA	Vin = 16V, 28V, 50V	1, 2, 3
Disabled Input Current (ENA2)		25	50	mA	Vin = 16V, 28V, 50V	1, 2, 3
Input Terminal Current Ripple (peak to peak)		40	60	mA	Bandwidth = 100 kHz – 10 MHz; see Figure 14	1, 2, 3
<b>OUTPUT CHARACTERISTICS</b>						
Output Voltage Set Point (T <sub>CASE</sub> = 25°C)	27.72	28.00	28.28	V	Vout at sense leads	1
Output Voltage Set Point Over Temperature	27.60	28.00	28.40	V	"	2, 3
Output Voltage Line Regulation	-20	0	20	mV	" ; Vin = 16V, 28V, 50V	1, 2, 3
Output Voltage Load Regulation	120	135	150	mV	" ; Vout @ (Iout=0A) - Vout @ (Iout=4A)	1, 2, 3
Total Output Voltage Range	27.44	28.00	28.56	V	"	1, 2, 3
Output Voltage Ripple and Noise Peak to Peak		30	100	mV	Bandwidth = 10 MHz; CL=11µF	1, 2, 3
Operating Output Current Range	0		4	A		1, 2, 3
Operating Output Power Range	0		112	W		1, 2, 3
Output DC Current-Limit Inception <sup>4</sup>	4.1	4.6	5.0	A		1, 2, 3
Short Circuit Output Current	4.1	4.8	5.5	A	Vout ≤ 1.2V	1, 2, 3
Back-Drive Current Limit while Enabled		1.2		A		1, 2, 3
Back-Drive Current Limit while Disabled		10	50	mA		1, 2, 3
Maximum Output Capacitance			3,000	µF		See Note 5
<b>DYNAMIC CHARACTERISTICS</b>						
Output Voltage Deviation Load Transient <sup>6</sup>						
For a Positive Step Change in Load Current	-1200	-650		mV	Total Iout step = 2A ↔ 4A, 0.4A ↔ 2A; CL=11µF	4, 5, 6
For a Negative Step Change in Load Current		650	1200	mV	"	4, 5, 6
Settling Time (either case) <sup>7</sup>		50	200	µs		4, 5, 6
Output Voltage Deviation Line Transient <sup>8</sup>						
For a Positive Step Change in Line Voltage	-800		800	mV	Vin step = 16V ↔ 50V; CL=11µF; Iout=3.5A	4, 5, 6
For a Negative Step Change in Line Voltage	-800		800	mV	"	4, 5, 6
Settling Time (either case) <sup>7</sup>		250	500	µs		See Note 5
Turn-On Transient						
Output Voltage Rise Time		6	10	ms	Vout = 2.8V → 25.2V	4, 5, 6
Output Voltage Overshoot		0	2	%		See Note 5
Turn-On Delay, Rising Vin <sup>9</sup>		5.5	8.0	ms	ENA1, ENA2 = 5V	4, 5, 6
Turn-On Delay, Rising ENA1		3.0	6.0	ms	ENA2 = 5V	4, 5, 6
Turn-On Delay, Rising ENA2		1.5	3.0	ms	ENA1 = 5V	4, 5, 6
<b>EFFICIENCY</b>						
Iout = 4A (16Vin)	84	88		%		1, 2, 3
Iout = 2A (16Vin)	88	91		%		1, 2, 3
Iout = 4A (28Vin)	84	88		%		1, 2, 3
Iout = 2A (28Vin)	87	91		%		1, 2, 3
Iout = 4A (40Vin)	83	87		%		1, 2, 3
Iout = 2A (40Vin)	85	89		%		1, 2, 3
Load Fault Power Dissipation		22	32	W	Iout at current limit inception point <sup>4</sup>	1, 2, 3
Short Circuit Power Dissipation		24	33	W	Vout ≤ 1.2V	1, 2, 3



**MQFL-28-28S**  
**Output: 28.0 V**  
**Current: 4 A**

# Technical Specification

## MQFL-28-28S ELECTRICAL CHARACTERISTICS (Continued)

Parameter	Min.	Nom.	Max.	Units	Notes & Conditions Vin=28V DC ±5%, Iout = 4A, CL = 0 µF, free running <sup>10</sup> unless otherwise specified	Group A Subgroup <sup>13</sup>
<b>ISOLATION CHARACTERISTICS</b>						
Isolation Voltage (dielectric strength)						
Input RTN to Output RTN	500			V		1
Any Input Pin to Case	500			V		1
Any Output Pin to Case	500			V		1
Isolation Resistance (input rtn to output rtn)	100			MΩ		1
Isolation Resistance (any pin to case)	100			MΩ		1
Isolation Capacitance (input rtn to output rtn)		44		nF		1
<b>FEATURE CHARACTERISTICS</b>						
Switching Frequency (free running)	500	550	600	kHz		1, 2, 3
Synchronization Input						
Frequency Range	500		700	kHz		1, 2, 3
Logic Level High	2		10	V		1, 2, 3
Logic Level Low	-0.5		0.8	V		1, 2, 3
Duty Cycle	20		80	%		See Note 5
Synchronization Output						
Pull Down Current	20			mA	VSYNC OUT = 0.8V	See Note 5
Duty Cycle	25		75	%	Output connected to SYNC IN of another MQFL converter	See Note 5
Enable Control (ENA1 and ENA2)						
Off-State Voltage			0.8	V		1, 2, 3
Module Off Pulldown Current	80			µA	Current drain required to ensure module is off	See Note 5
On-State Voltage	2			V		1, 2, 3
Module On Pin Leakage Current			20	µA	Maximum current draw from pin allowed with module still on	See Note 5
Pull-Up Voltage	3.2	4.0	4.5	V	See Figure A	1, 2, 3
<b>RELIABILITY CHARACTERISTICS</b>						
Calculated MTBF (MIL-STD-217F2)						
GB @ T <sub>case</sub> =70°C		2800		10 <sup>3</sup> Hrs.		
AIF @ T <sub>case</sub> =70°C		440		10 <sup>3</sup> Hrs.		
Demonstrated MTBF		TBD		10 <sup>3</sup> Hrs.		
<b>WEIGHT CHARACTERISTICS</b>						
Device Weight		79		g		

### Electrical Characteristics Notes

1. Converter will undergo input over-voltage shutdown.
2. Derate output power to 50% of rated power at T<sub>case</sub> = 135° C.
3. High or low state of input voltage must persist for about 200µs to be acted on by the lockout or shutdown circuitry.
4. Current limit inception is defined as the point where the output voltage has dropped to 90% of its nominal value.
5. Parameter not tested but guaranteed to the limit specified.
6. Load current transition time ≥ 10µs.
7. Settling time measured from start of transient to the point where the output voltage has returned to ±1% of its final value.
8. Line voltage transition time ≥ 100µs.
9. Input voltage rise time ≤ 250µs.
10. Operating the converter at a synchronization frequency above the free running frequency will cause the converter's efficiency to be slightly reduced and it may also cause a slight reduction in the maximum output current/power available. For more information consult the factory.
11. After a disable or fault event, module is inhibited from restarting for 300ms. See Shut Down section on Page 9.
12. SHARE pin outputs a power failure warning pulse during a fault condition. See Current Share section on Page 11.
13. Only the ES and HB grade products are tested at three temperatures. The B and C grade products are tested at one temperature. Please refer to the ESS table on Page 13 for details.
14. These derating curves apply for the ES- and HB- grade products. The C- grade product has a maximum case temperature of 100° C and a maximum junction temperature rise of 20° C above T<sub>CASE</sub>. The B- grade product has a maximum case temperature of 85° C and a maximum junction temperature rise of 20° C at full load.



# Technical Specification

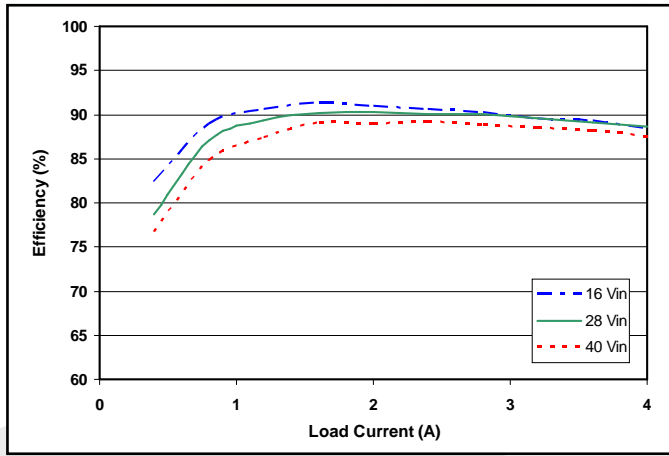

Figure 1: Efficiency at nominal output voltage vs. load current for minimum, nominal, and maximum input voltage at  $T_{CASE}=25^{\circ}C$ .

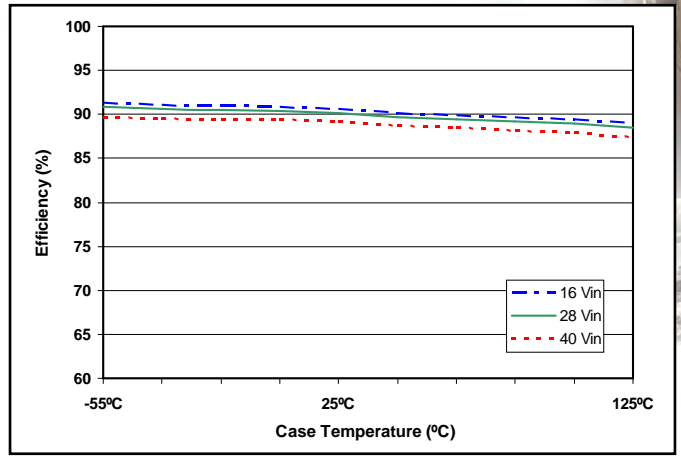

Figure 2: Efficiency at nominal output voltage and 60% rated power vs. case temperature for input voltage of 16V, 28V, and 40V.

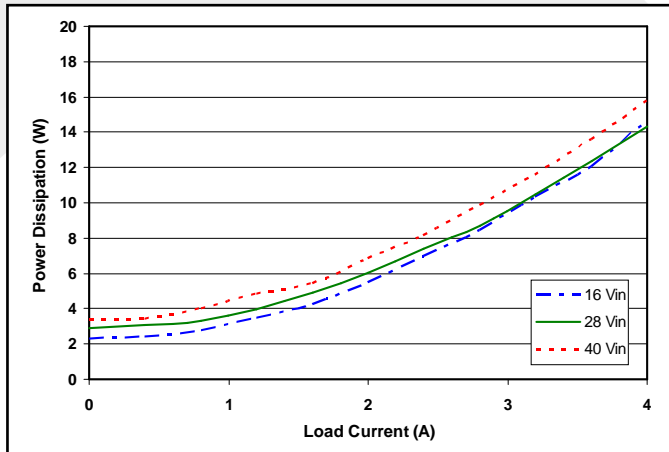

Figure 3: Power dissipation at nominal output voltage vs. load current for minimum, nominal, and maximum input voltage at  $T_{CASE}=25^{\circ}C$ .

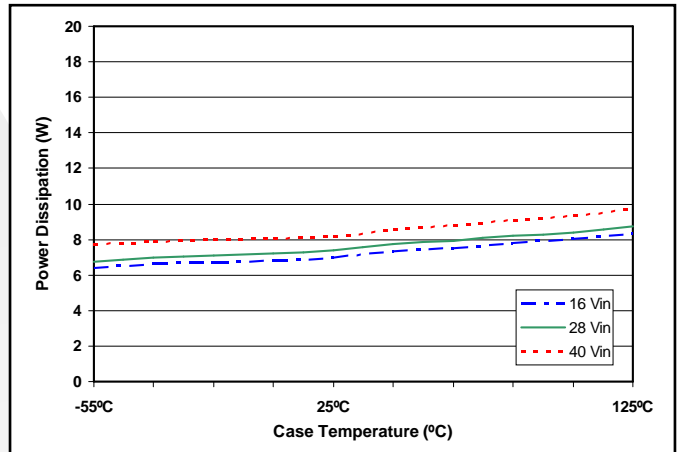

Figure 4: Power dissipation at nominal output voltage and 60% rated power vs. case temperature for input voltage of 16V, 28V, and 40V.

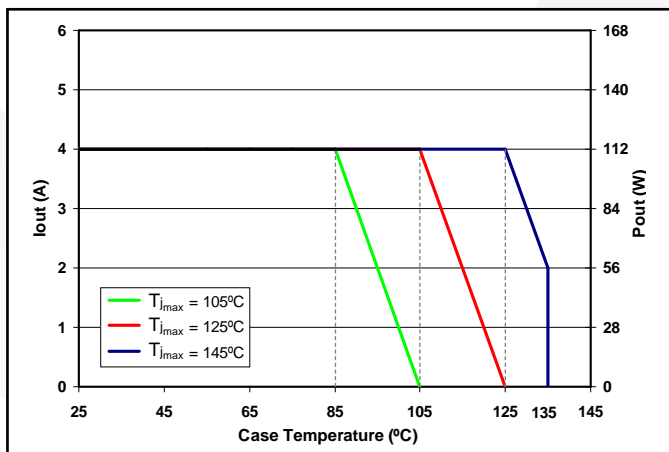

Figure 5: Output Current / Output Power derating curve as a function of  $T_{CASE}$  and the Maximum desired power MOSFET junction temperature at  $V_{in} = 28V$  (see Note 14).

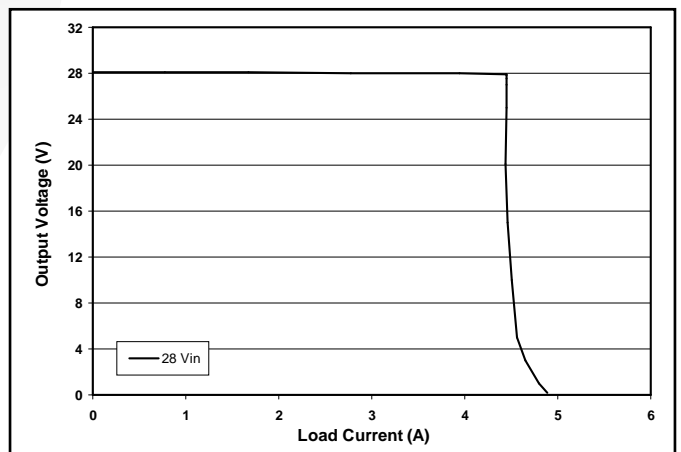
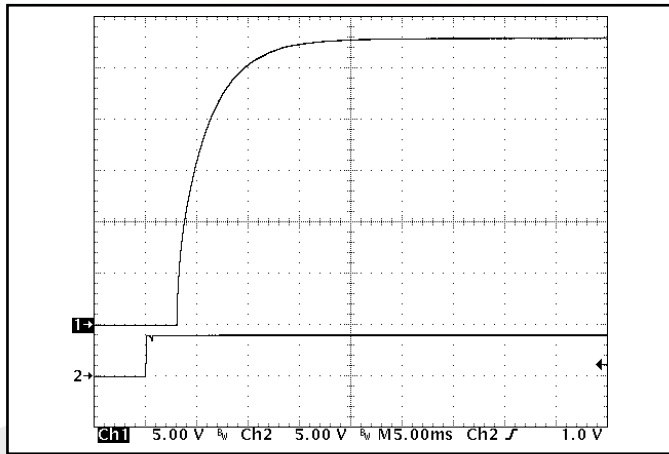
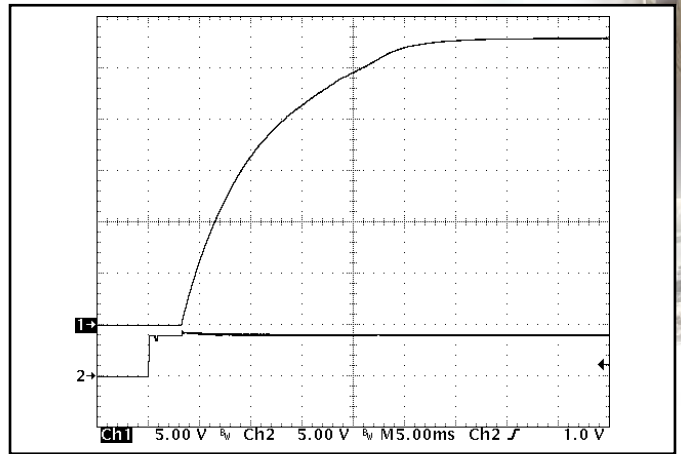

Figure 6: Output voltage vs. load current showing typical current limit curves.



**Figure 7:** Turn-on transient at full resistive load and zero output capacitance initiated by ENA1. Input voltage pre-applied. Ch 1: Vout (5V/div). Ch 2: ENA1 (5V/div).



**Figure 8:** Turn-on transient at full resistive load and 3 mF output capacitance initiated by ENA1. Input voltage pre-applied. Ch 1: Vout (5V/div). Ch 2: ENA1 (5V/div).

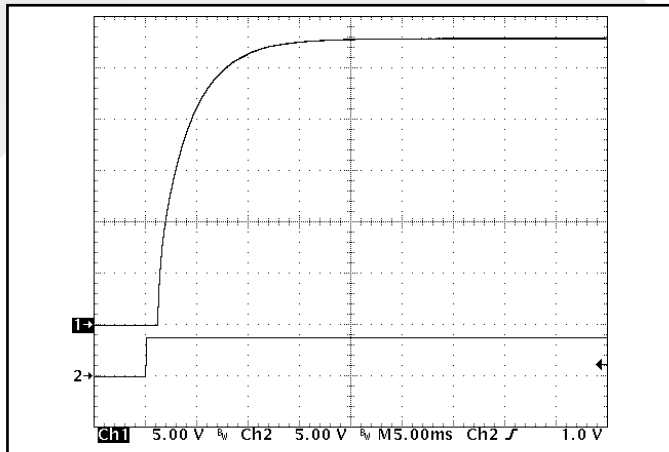

**Figure 9:** Turn-on transient at full resistive load and zero output capacitance initiated by ENA2. Input voltage pre-applied. Ch 1: Vout (5V/div). Ch 2: ENA2 (5V/div).

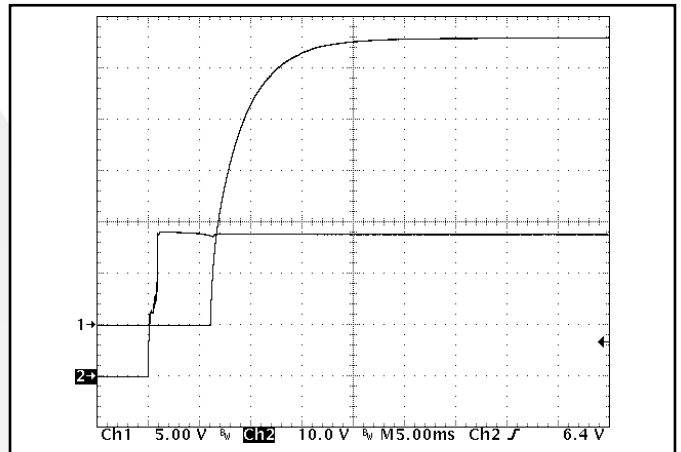

**Figure 10:** Turn-on transient at full resistive load and zero output capacitance initiated by Vin. ENA1 and ENA2 both previously high. Ch 1: Vout (5V/div). Ch 2: Vin (10V/div).

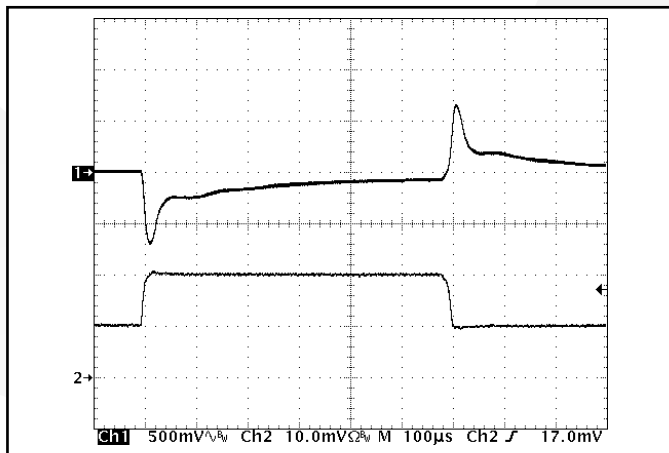

**Figure 11:** Output voltage response to step-change in load current (50%-100%-50% of Iout(max)). Load cap: 1µF ceramic cap and 10µF, 100 mΩ ESR tantalum cap. Ch 1: Vout (500mV/div). Ch 2: Iout (2A/div).

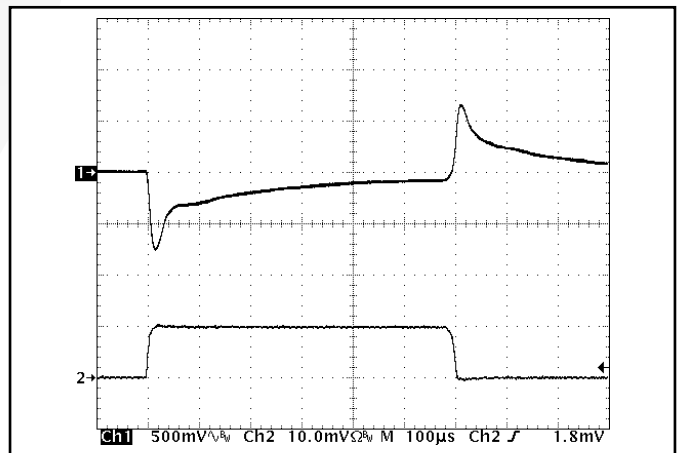

**Figure 12:** Output voltage response to step-change in load current (0%-50%-0% of Iout(max)). Load cap: 1µF ceramic cap and 10µF, 100 mΩ ESR tantalum cap. Ch 1: Vout (500mV/div). Ch 2: Iout (2A/div).

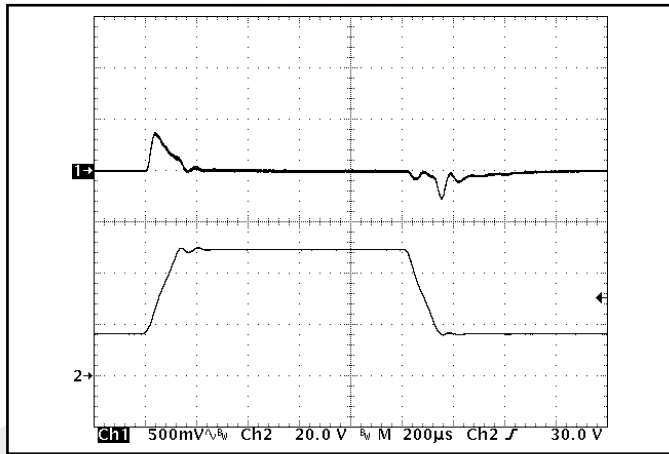

**Figure 13:** Output voltage response to step-change in input voltage (16V - 50V - 16V). Load cap: 10µF, 100 mΩ ESR tantalum cap and 1µF ceramic cap. Ch 1: Vout (500mV/div). Ch 2: Vin (20V/div).

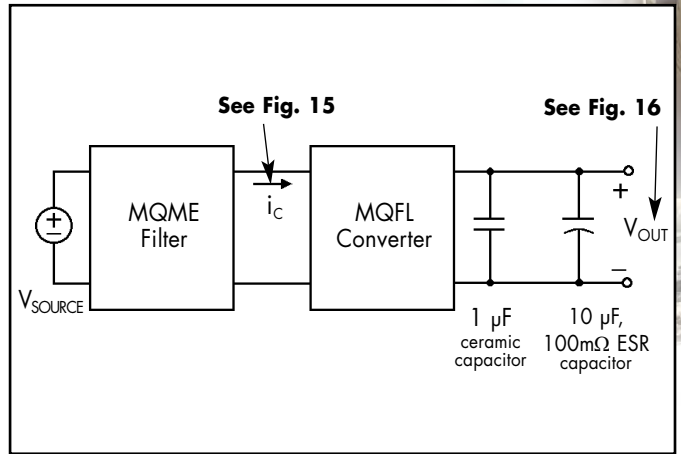

**Figure 14:** Test set-up diagram showing measurement points for Input Terminal Ripple Current (Figure 15) and Output Voltage Ripple (Figure 16).

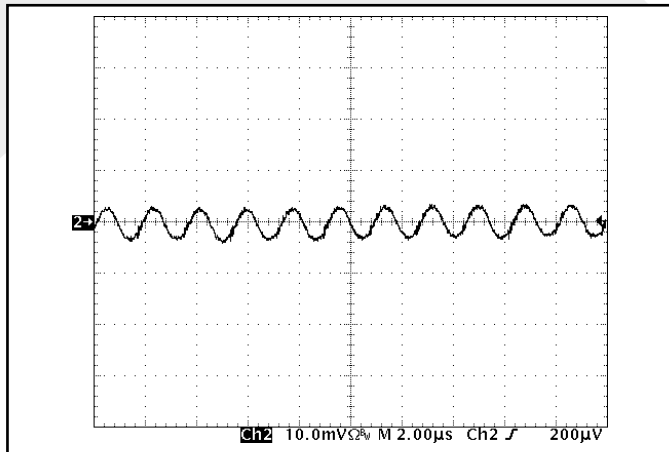

**Figure 15:** Input terminal current ripple,  $i_c$ , at full rated output current and nominal input voltage with SynQor MQ filter module (50 mA/div). Bandwidth: 20MHz. See Figure 14.

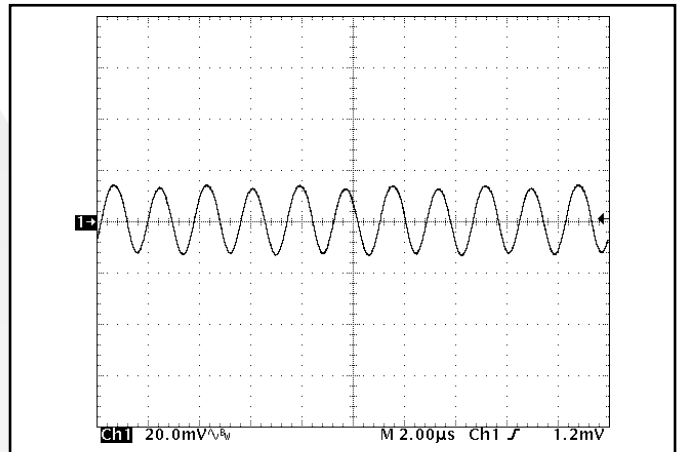

**Figure 16:** Output voltage ripple, Vout, at nominal input voltage and rated load current (20 mV/div). Load capacitance: 1µF ceramic capacitor and 10µF tantalum capacitor. Bandwidth: 10 MHz. See Figure 14.

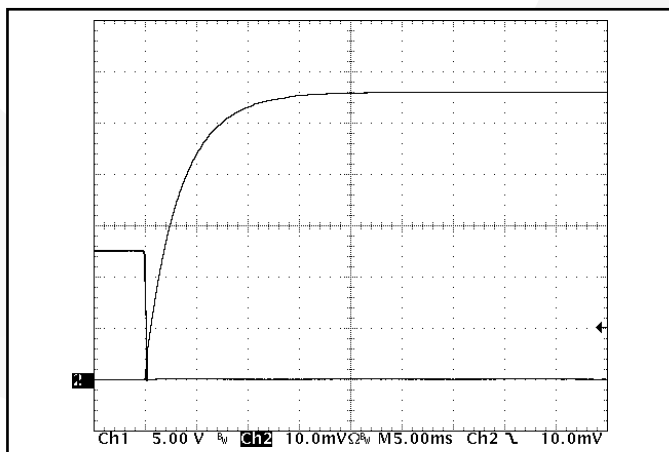

**Figure 17:** Rise of output voltage after the removal of a short circuit across the output terminals. Ch 1: Vout (5V/div). Ch 2: Iout (2A/div).

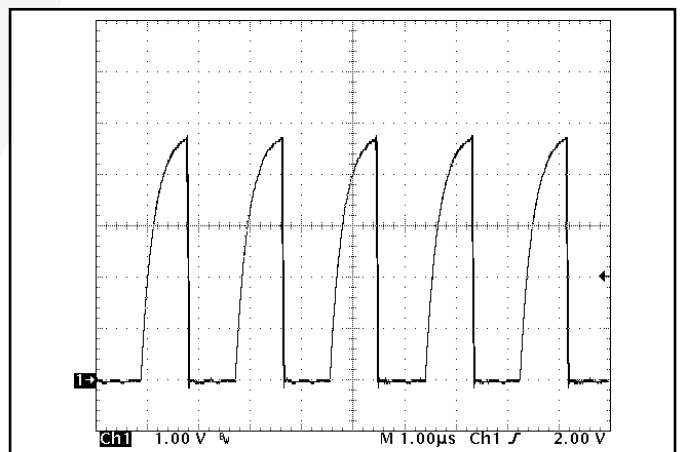

**Figure 18:** SYNC OUT vs. time, driving SYNC IN of a second SynQor MQFL converter. Ch1: SYNC OUT: (1V/div).

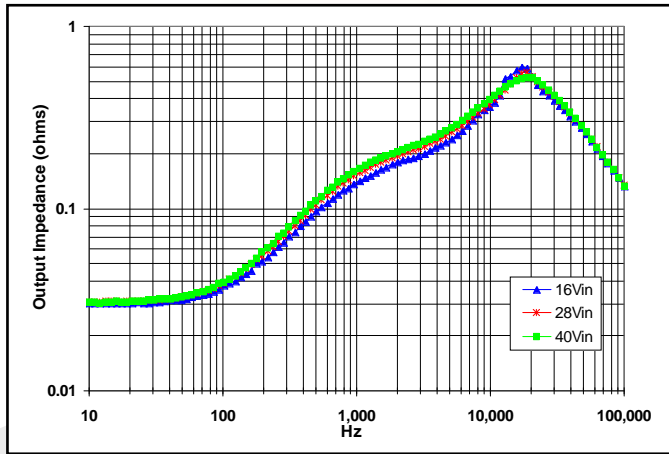

**Figure 19:** Magnitude of incremental output impedance ( $Z_{out} = v_{out}/i_{out}$ ) for minimum, nominal, and maximum input voltage at full rated power.

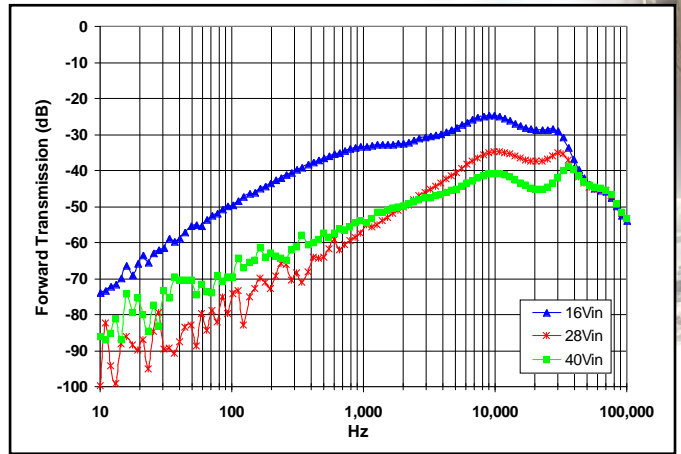

**Figure 20:** Magnitude of incremental forward transmission ( $FT = v_{out}/v_{in}$ ) for minimum, nominal, and maximum input voltage at full rated power.

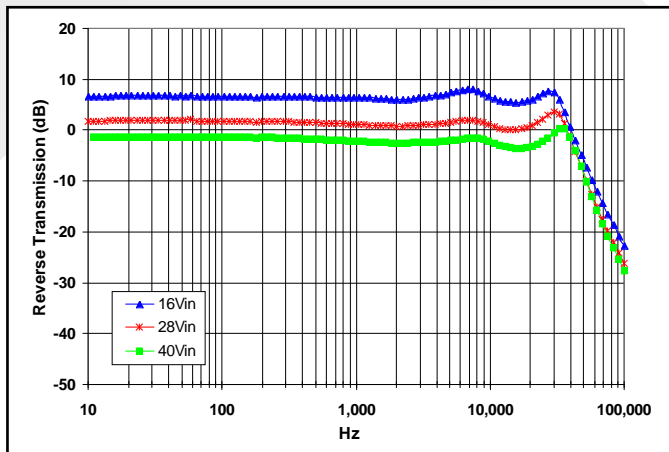

**Figure 21:** Magnitude of incremental reverse transmission ( $RT = i_{in}/i_{out}$ ) for minimum, nominal, and maximum input voltage at full rated power.

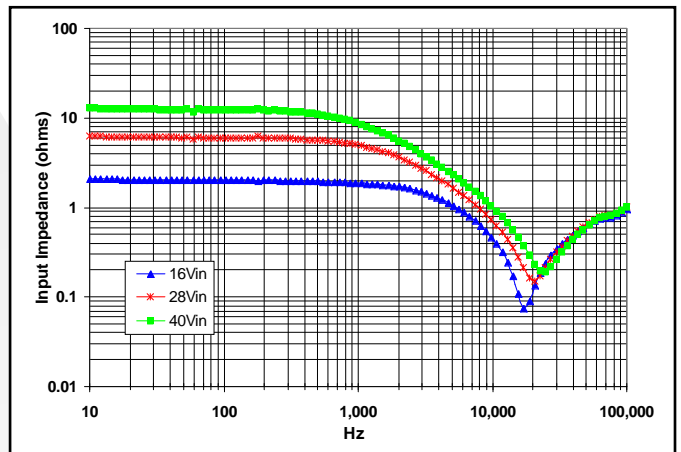

**Figure 22:** Magnitude of incremental input impedance ( $Z_{in} = v_{in}/i_{in}$ ) for minimum, nominal, and maximum input voltage at full rated power.

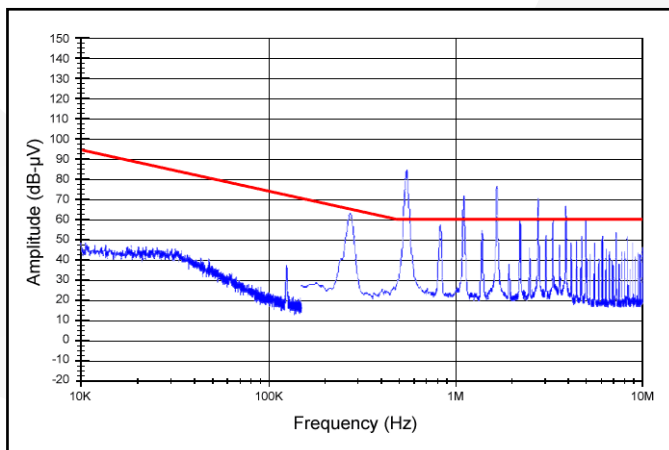

**Figure 23:** High frequency conducted emissions of standalone MQFL-28-05S, 5Vout module at 120W output, as measured with Method CE102. Limit line shown is the 'Basic Curve' for all applications with a 28V source.

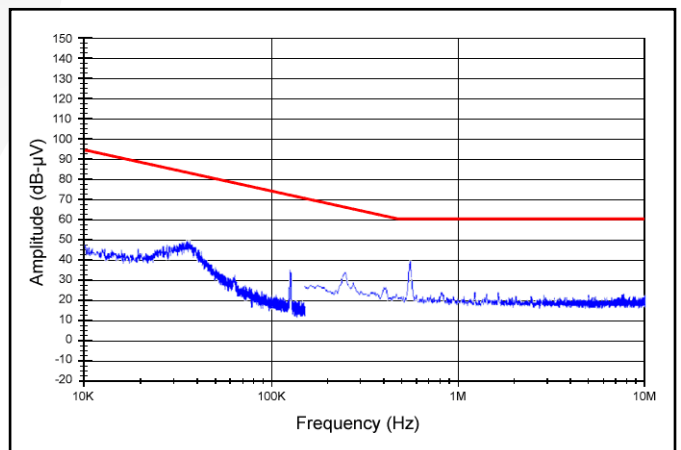

**Figure 24:** High frequency conducted emissions of MQFL-28-05S, 5Vout module at 120W output with MQFL-28-P filter, as measured with Method CE102. Limit line shown is the 'Basic Curve' for all applications with a 28V source.

### BASIC OPERATION AND FEATURES

The MQFL DC/DC converter uses a two-stage power conversion topology. The first, or regulation, stage is a buck-converter that keeps the output voltage constant over variations in line, load, and temperature. The second, or isolation, stage uses transformers to provide the functions of input/output isolation and voltage transformation to achieve the output voltage required.

Both the regulation and the isolation stages switch at a fixed frequency for predictable EMI performance. The isolation stage switches at one half the frequency of the regulation stage, but due to the push-pull nature of this stage it creates a ripple at double its switching frequency. As a result, both the input and the output of the converter have a fundamental ripple frequency of about 550 kHz in the free-running mode.

Rectification of the isolation stage's output is accomplished with synchronous rectifiers. These devices, which are MOSFETs with a very low resistance, dissipate far less energy than would Schottky diodes. This is the primary reason why the MQFL converters have such high efficiency, particularly at low output voltages.

Besides improving efficiency, the synchronous rectifiers permit operation down to zero load current. There is no longer a need for a minimum load, as is typical for converters that use diodes for rectification. The synchronous rectifiers actually permit a negative load current to flow back into the converter's output terminals if the load is a source of short or long term energy. The MQFL converters employ a "back-drive current limit" to keep this negative output terminal current small.

There is a control circuit on both the input and output sides of the MQFL converter that determines the conduction state of the power switches. These circuits communicate with each other across the isolation barrier through a magnetically coupled device. No opto-isolators are used.

A separate bias supply provides power both the input and output control circuits. Among other things, this bias supply permits the converter to operate indefinitely into a short circuit and to avoid a hiccup mode, even under a tough start-up condition.

An input under-voltage lockout feature with hysteresis is provided, as well as an input over-voltage shutdown. There is also an output current limit that is nearly constant as the load impedance decreases to a short circuit (i.e., there is not fold-back or fold-forward characteristic to the output current under this condition). When a load fault is removed, the output voltage rises exponentially to its nominal value without an overshoot.

The MQFL converter's control circuit does not implement an output over-voltage limit or an over-temperature shutdown.

The following sections describe the use and operation of additional control features provided by the MQFL converter.

### CONTROL FEATURES

**ENABLE:** The MQFL converter has two enable pins. Both must have a logic high level for the converter to be enabled. A logic low on either pin will inhibit the converter.

The ENA1 pin (pin 4) is referenced with respect to the converter's input return (pin 2). The ENA2 pin (pin 12) is referenced with respect to the converter's output return (pin 8). This permits the converter to be inhibited from either the input or the output side.

Regardless of which pin is used to inhibit the converter, the regulation and the isolation stages are turned off. However, when the converter is inhibited through the ENA1 pin, the bias supply is also turned off, whereas this supply remains on when the converter is inhibited through the ENA2 pin. A higher input standby current therefore results in the latter case.

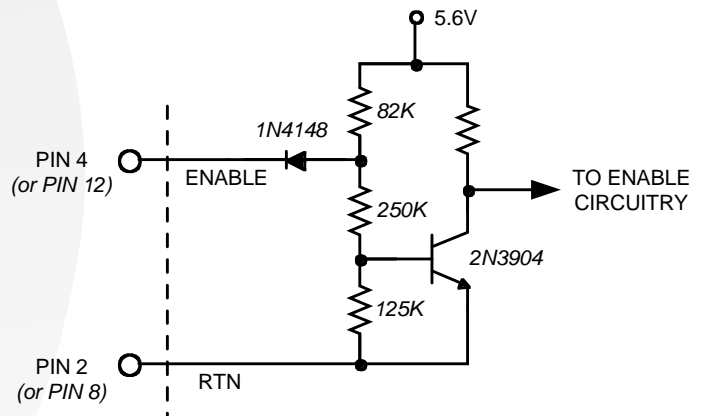

**Figure A:** Equivalent circuit looking into either the ENA1 or ENA2 pins with respect to its corresponding return pin.

Both enable pins are internally pulled high so that an open connection on both pins will enable the converter. Figure A shows the equivalent circuit looking into either enable pins. It is TTL compatible.

**SHUT DOWN:** The MQFL converter will shut down in response to only four conditions: ENA1 input low, ENA2 input low, VIN input below under-voltage lockout threshold, or VIN input above over-voltage shutdown threshold. Following a shutdown event, there is a startup inhibit delay which will prevent the converter

from restarting for approximately 300ms. After the 300ms delay elapses, if the enable inputs are high and the input voltage is within the operating range, the converter will restart. If the VIN input is brought down to nearly 0V and back into the operating range, there is no startup inhibit, and the output voltage will rise according to the "Turn-On Delay, Rising Vin" specification.

**REMOTE SENSE:** The purpose of the remote sense pins is to correct for the voltage drop along the conductors that connect the converter's output to the load. To achieve this goal, a separate conductor should be used to connect the +SENSE pin (pin 10) directly to the positive terminal of the load, as shown in the connection diagram on Page 2. Similarly, the -SENSE pin (pin 9) should be connected through a separate conductor to the return terminal of the load.

**NOTE:** Even if remote sensing of the load voltage is not desired, the +SENSE and the -SENSE pins must be connected to +Vout (pin 7) and OUTPUT RETURN (pin 8), respectively, to get proper regulation of the converter's output. If they are left open, the converter will have an output voltage that is approximately 200mV higher than its specified value. If only the +SENSE pin is left open, the output voltage will be approximately 25mV too high.

Inside the converter, +SENSE is connected to +Vout with a 100Ω resistor and -SENSE is connected to OUTPUT RETURN with a 10Ω resistor.

It is also important to note that when remote sense is used, the voltage across the converter's output terminals (pins 7 and 8) will be higher than the converter's nominal output voltage due to resistive drops along the connecting wires. This higher voltage at the terminals produces a greater voltage stress on the converter's internal components and may cause the converter to fail to deliver the desired output voltage at the low end of the input voltage range at the higher end of the load current and temperature range. Please consult the factory for details.

**SYNCHRONIZATION:** The MQFL converter's switching frequency can be synchronized to an external frequency source that is in the 500 kHz to 700 kHz range. A pulse train at the desired frequency should be applied to the SYNC IN pin (pin 6) with respect to the INPUT RETURN (pin 2). This pulse train should have a duty cycle in the 20% to 80% range. Its low value should be below 0.8V to be guaranteed to be interpreted as a logic low, and its high value should be above 2.0V to be guaranteed to be interpreted as a logic high. The transition time between the two states should be less than 300ns.

If the MQFL converter is not to be synchronized, the SYNC IN pin should be left open circuit. The converter will then operate in its free-running mode at a frequency of approximately 550 kHz.

If, due to a fault, the SYNC IN pin is held in either a logic low or logic high state continuously, the MQFL converter will revert to its free-running frequency.

The MQFL converter also has a SYNC OUT pin (pin 5). This output can be used to drive the SYNC IN pins of as many as ten (10) other MQFL converters. The pulse train coming out of SYNC OUT has a duty cycle of 50% and a frequency that matches the switching frequency of the converter with which it is associated. This frequency is either the free-running frequency if there is no synchronization signal at the SYNC IN pin, or the synchronization frequency if there is.

The SYNC OUT signal is available only when the DC input voltage is above approximately 12V and when the converter is not inhibited through the ENA1 pin. An inhibit through the ENA2 pin will not turn the SYNC OUT signal off.

**NOTE:** An MQFL converter that has its SYNC IN pin driven by the SYNC OUT pin of a second MQFL converter will have its start of its switching cycle delayed approximately 180 degrees relative to that of the second converter.

Figure B shows the equivalent circuit looking into the SYNC IN pin. Figure C shows the equivalent circuit looking into the SYNC OUT pin.

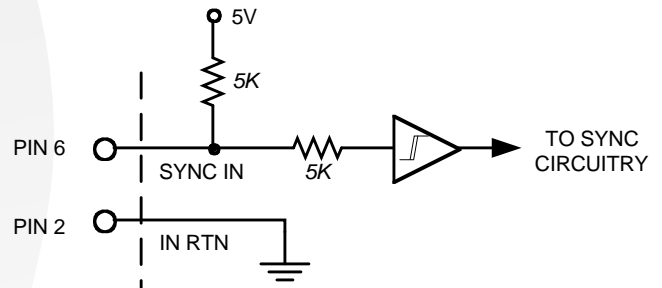

**Figure B:** Equivalent circuit looking into the SYNC IN pin with respect to the IN RTN (input return) pin.

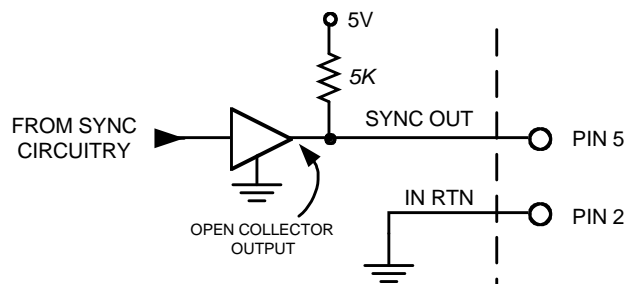

**Figure C:** Equivalent circuit looking into SYNC OUT pin with respect to the IN RTN (input return) pin.



# Technical Specification

**MQFL-28-28S**  
**Output: 28.0 V**  
**Current: 4 A**

**CURRENT SHARE:** When several MQFL converters are placed in parallel to achieve either a higher total load power or N+1 redundancy, their SHARE pins (pin 11) should be connected together. The voltage on this common SHARE node represents the average current delivered by all of the paralleled converters. Each converter monitors this average value and adjusts itself so that its output current closely matches that of the average.

Since the SHARE pin is monitored with respect to the OUTPUT RETURN (pin 8) by each converter, it is important to connect all of the converters' OUTPUT RETURN pins together through a low DC and AC impedance. When this is done correctly, the converters will deliver their appropriate fraction of the total load current to within +/- 10% at full rated load.

Whether or not converters are paralleled, the voltage at the SHARE pin could be used to monitor the approximate average current delivered by the converter(s). A nominal voltage of 1.0V represents zero current and a nominal voltage of 2.2V represents the maximum rated current, with a linear relationship in between. The internal source resistance of a converter's SHARE pin signal is 2.5 kΩ. During an input voltage fault or primary disable event, the SHARE pin outputs a power failure warning pulse. The SHARE pin will go to 3V for approximately 14ms as the output voltage falls.

**NOTE:** Converters operating from separate input filters with reverse polarity protection (such as the MQME-28-T filter) with their outputs connected in parallel may exhibit hiccup operation at light loads. Consult factory for details.

**OUTPUT VOLTAGE TRIM:** If desired, it is possible to increase the MQFL converter's output voltage above its nominal value. To do this, use the +SENSE pin (pin 10) for this trim function instead of for its normal remote sense function, as shown in Figure D. In this case, a resistor connects the +SENSE pin to the -SENSE pin

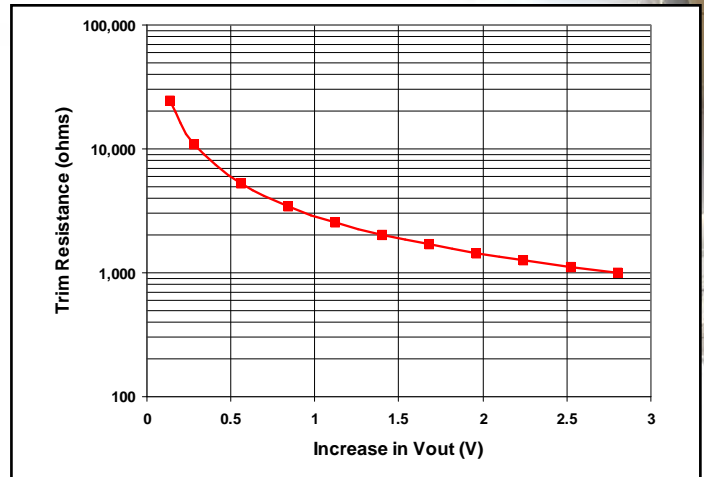

Figure E: Output Voltage Trim Graph

(which should still be connected to the output return, either remotely or locally). The value of the trim resistor should be chosen according to the following equation or from Figure E:

$$R_{trim} = 100 \times \left[ \frac{V_{nom}}{V_{out} - V_{nom} - 0.025} \right]$$

where:

- V<sub>nom</sub> = the converter's nominal output voltage,
- V<sub>out</sub> = the desired output voltage (greater than V<sub>nom</sub>), and
- R<sub>trim</sub> is in Ohms.

As the output voltage is trimmed up, it produces a greater voltage stress on the converter's internal components and may cause the converter to fail to deliver the desired output voltage at the low end of the input voltage range at the higher end of the load current and temperature range. Please consult the factory for details. Factory trimmed converters are available by request.

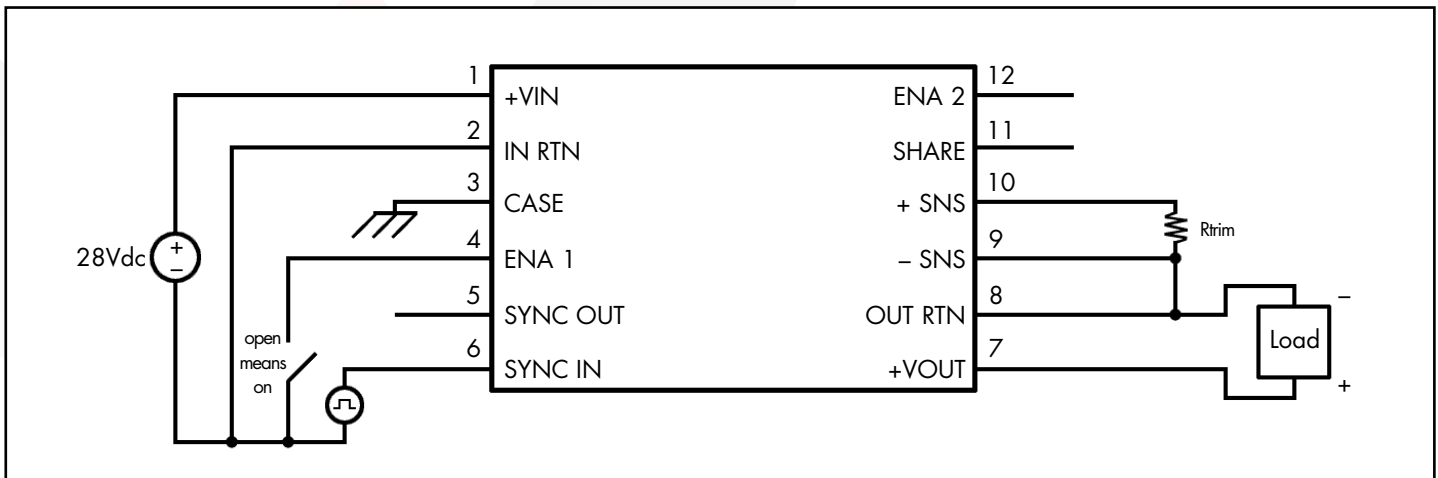

Figure D: Typical connection for output voltage trimming.



## Technical Specification

**MQFL-28-28S**  
**Output: 28.0 V**  
**Current: 4 A**

**INPUT UNDER-VOLTAGE LOCKOUT:** The MQFL converter has an under-voltage lockout feature that ensures the converter will be off if the input voltage is too low. The threshold of input voltage at which the converter will turn on is higher than the threshold at which it will turn off. In addition, the MQFL converter will not respond to a state of the input voltage unless it has remained in that state for more than about 200 $\mu$ s. This hysteresis and the delay ensure proper operation when the source impedance is high or in a noisy environment.

**INPUT OVER-VOLTAGE SHUTDOWN:** The MQFL converter also has an over-voltage feature that ensures the converter will be off if the input voltage is too high. It also has a hysteresis and time delay to ensure proper operation.

**BACK-DRIVE CURRENT LIMIT:** Converters that use MOSFETs as synchronous rectifiers are capable of drawing a negative current from the load if the load is a source of short- or long-term energy. This negative current is referred to as a "back-drive current".

Conditions where back-drive current might occur include paralleled converters that do not employ current sharing, or where the current share feature does not adequately ensure sharing during the startup or shutdown transitions. It can also occur when converters having different output voltages are connected together through either explicit or parasitic diodes that, while normally off, become conductive during startup or shutdown. Finally, some loads, such as motors, can return energy to their power rail. Even a load capacitor is a source of back-drive energy for some period of time during a shutdown transient.

To avoid any problems that might arise due to back-drive current, the MQFL converters limit the negative current that the converter can draw from its output terminals. The threshold for this back-drive current limit is placed sufficiently below zero so that the converter may operate properly down to zero load, but its absolute value (see the [Electrical Characteristics](#) page) is small compared to the converter's rated output current.

**THERMAL CONSIDERATIONS:** Figure 5 shows the suggested Power Derating Curves for this converter as a function of the case temperature and the maximum desired power MOSFET junction temperature. All other components within the converter are cooler than its hottest MOSFET, which at full power is no more than 20°C higher than the case temperature directly below this MOSFET.

The Mil-HDBK-1547A component derating guideline calls for a maximum component temperature of 105°C. Figure 5 therefore has one power derating curve that ensures this limit is maintained. It has been SynQor's extensive experience that reliable long-term converter operation can be achieved with a maximum component temperature of 125°C. In extreme cases, a maximum temperature of 145°C is permissible, but not recommended for long-term operation where high reliability is required. Derating curves for these higher temperature limits are also included in Figure 5. The maximum case temperature at which the converter should be operated is 135°C.

When the converter is mounted on a metal plate, the plate will help to make the converter's case bottom a uniform temperature. How well it does so depends on the thickness of the plate and on the thermal conductance of the interface layer (e.g. thermal grease, thermal pad, etc.) between the case and the plate. Unless this is done very well, it is important not to mistake the plate's temperature for the maximum case temperature. It is easy for them to be as much as 5-10°C different at full power and at high temperatures. It is suggested that a thermocouple be attached directly to the converter's case through a small hole in the plate when investigating how hot the converter is getting. Care must also be made to ensure that there is not a large thermal resistance between the thermocouple and the case due to whatever adhesive might be used to hold the thermocouple in place.

**INPUT SYSTEM INSTABILITY:** This condition can occur because any DC/DC converter appears incrementally as a negative resistance load. A detailed application note titled "Input System Instability" is available on the [SynQor website](#) which provides an understanding of why this instability arises, and shows the preferred solution for correcting it.



# Technical Specification

**MQFL-28-28S**  
**Output: 28.0 V**  
**Current: 4 A**

## CONSTRUCTION AND ENVIRONMENTAL STRESS SCREENING OPTIONS

Screening	Consistent with MIL-STD-883F	B-Grade (-40°C to +85°C)	C-Grade (-40°C to +100°C)	ES-Grade (-55°C to +125°C) (Element Evaluation)	HB-Grade (-55°C to +125°C) (Element Evaluation)
Internal Visual	*	Yes	Yes	Yes	Yes
Temperature Cycle	Method 1010	No	No	Condition B (-55°C to +125°C)	Condition C (-65°C to +150°C)
Constant Acceleration	Method 2001 (Y1 Direction)	No	No	500g	Condition A (5000g)
Burn-in	Method 1015 Load Cycled •10s period •2s @ 100% Load •8s @ 0% Load	12 Hrs @ +100°C	24 Hrs @ +125°C	96 Hrs @ +125°C	160 Hrs @ +125°C
Final Electrical Test	Method 5005 (Group A)	+25°C	+25°C	-45, +25, +100°C	-55, +25, +125°C
Mechanical Seal, Thermal, and Coating Process		Anodized Package	Full QorSeal	Full QorSeal	Full QorSeal
External Visual	2009	*	*	Yes	Yes
Construction Process		Ruggedized	QorSeal	QorSeal	QorSeal
* Per IPC-A-610 (Rev. D) Class 3					

MilQor converters and filters are offered in four variations of construction technique and environmental stress screening options. The three highest grades, C, ES, and HB, all use SynQor's proprietary QorSeal™ Hi-Rel assembly process that includes a Parylene-C coating of the circuit, a high performance thermal compound filler, and a nickel barrier gold plated aluminum case. The B-grade version uses a ruggedized assembly process that includes a medium performance thermal compound filler and a black anodized aluminum case†. Each successively higher grade has more stringent mechanical and electrical testing, as well as a longer burn-in cycle. The ES- and HB-Grades are also constructed of components that have been procured through an element evaluation process that pre-qualifies each new batch of devices.

† Note: Since the surface of the black anodized case is not guaranteed to be electrically conductive, a star washer or similar device should be used to cut through the surface oxide if electrical connection to the case is desired.



# Technical Specification

**MQFL-28-28S**  
**Output: 28.0 V**  
**Current: 4 A**

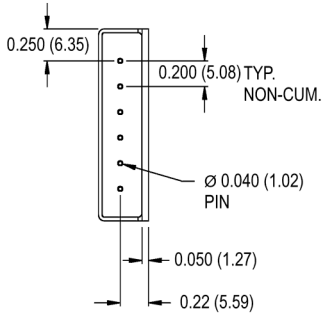
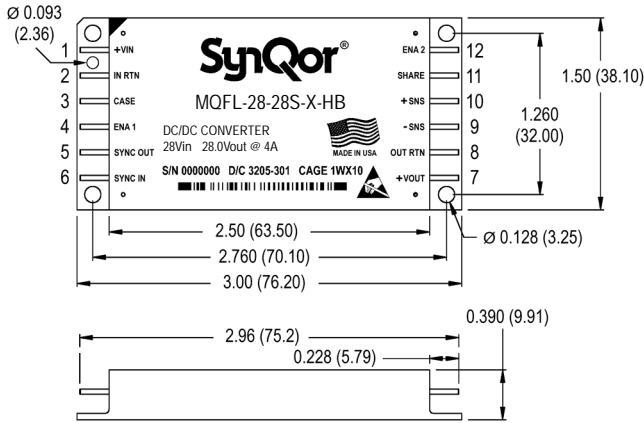

**Case X**

## PACKAGE PINOUTS

Pin # Function

Pin #	Function
1	POSITIVE INPUT
2	INPUT RETURN
3	CASE
4	ENABLE 1
5	SYNC OUTPUT
6	SYNC INPUT
7	POSITIVE OUTPUT
8	OUTPUT RETURN
9	- SENSE
10	+ SENSE
11	SHARE
12	ENABLE 2

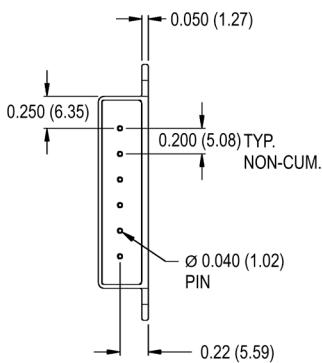
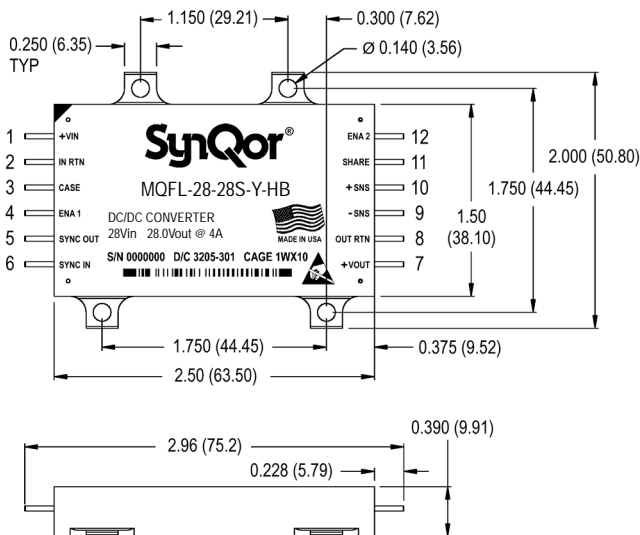

**Case Y**

**Case W (variation of Y)**

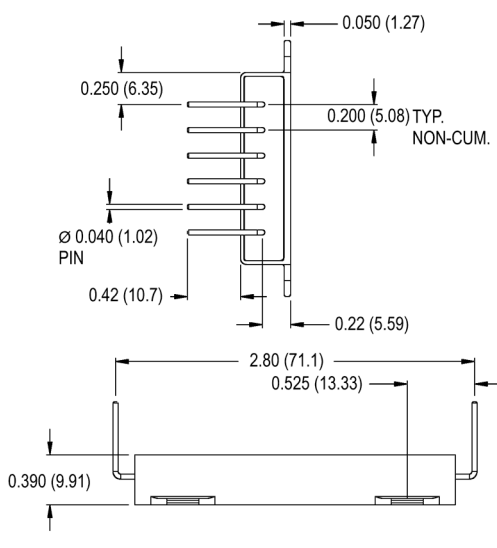

**Case Z (variation of Y)**

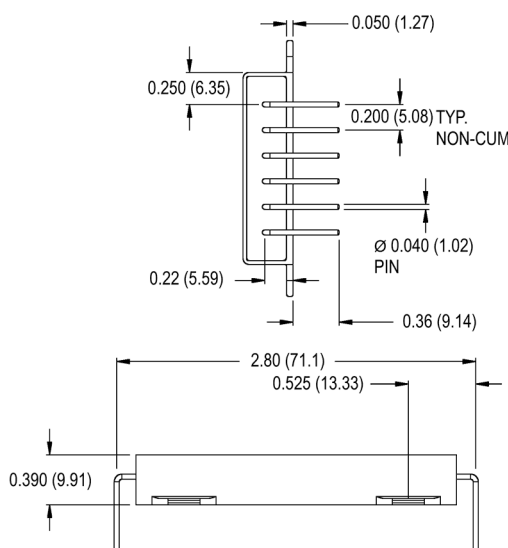

## NOTES

- Case: Aluminum with gold over nickel plate finish for the C-, ES-, and HB-Grade products.  
Aluminum with black anodized finish for the B-Grade products.
- Pins: Diameter: 0.040" (1.02mm)  
Material: Copper  
Finish: Gold over Nickel plate
- All dimensions as inches (mm)
- Tolerances: a) x.xx ±0.02"  
(x.x ±0.5mm)  
b) x.xxx ±0.010"  
(x.xx ±0.25mm)
- Weight: 2.8 oz. (79 g) typical
- Workmanship: Meets or exceeds IPC-A-610C Class III



# Technical Specification

**MQFL-28-28S**  
**Output: 28.0 V**  
**Current: 4 A**

## MilQor MQFL FAMILY MATRIX

The tables below show the array of MQFL converters available. When ordering SynQor converters, please ensure that you use the complete part number according to the table in the last page. Contact the factory for other requirements.

### Single Output Converters

	1.5V (1R5S)	1.8V (1R8S)	2.5V (2R5S)	3.3V (3R3S)	5V (05S)	6V (06S)	7.5V (7R5S)	9V (09S)	12V (12S)	15V (15S)	28V (28S)
<b>MQFL-28</b> 16-40Vin Cont. 16-50Vin 1s Trans.* Absolute Max Vin = 60V	40A	40A	40A	30A	24A	20A	16A	13A	10A	8A	4A
<b>MQFL-28E</b> 16-70Vin Cont. 16-80Vin 1s Trans.* Absolute Max Vin =100V	40A	40A	40A	30A	24A	20A	16A	13A	10A	8A	4A
<b>MQFL-28V</b> 16-40Vin Cont. 5.5-50Vin 1s Trans.* Absolute Max Vin = 60V	40A	40A	40A	30A	20A	17A	13A	11A	8A	6.5	3.3A
<b>MQFL-28VE</b> 16-70Vin Cont. 5.5-80Vin 1s Trans.* Absolute Max Vin = 100V	40A	40A	40A	30A	20A	17A	13A	11A	8A	6.5	3.3A
<b>MQFL-270</b> 155-400Vin Cont. 155-475Vin 0.1s Trans.* Absolute Max Vin = 550V	40A	40A	40A	30A	24A	20A	16A	13A	10A	8A	4A
<b>MQFL-270E</b> 130-475Vin Cont. 130-520Vin 0.1s Trans.* Absolute Max Vin = 600V	40A	40A	40A	30A	20A	17A	13A	11A	8A	6.5	3.3A
<b>MQFL-270L</b> 65-350Vin Cont. 65-475Vin 0.1s Trans.* Absolute Max Vin = 550V	40A	40A	30A	22A	15A	12A	10A	8A	6A	5A	2.7A

### Dual Output Converters†

	±5V (05D)	±12V (12D)	±15V (15D)
<b>MQFL-28</b> 16-40Vin Cont. 16-50Vin 1s Trans.* Absolute Max Vin = 60V	20A Total	10A Total	8A Total
<b>MQFL-28E</b> 16-70Vin Cont. 16-80Vin 1s Trans.* Absolute Max Vin =100V	20A Total	10A Total	8A Total
<b>MQFL-28V</b> 16-40Vin Cont. 5.5-50Vin 1s Trans.* Absolute Max Vin = 60V	20A Total	8A Total	6.5A Total
<b>MQFL-28VE</b> 16-70Vin Cont. 5.5-80Vin 1s Trans.* Absolute Max Vin = 100V	20A Total	8A Total	6.5A Total
<b>MQFL-270</b> 155-400Vin Cont. 155-475Vin 0.1s Trans.* Absolute Max Vin = 550V	20A Total	10A Total	8A Total
<b>MQFL-270E</b> 130-475Vin Cont. 130-520Vin 0.1s Trans.* Absolute Max Vin = 600V	20A Total	8A Total	6.5A Total
<b>MQFL-270L</b> 65-350Vin Cont. 65-475Vin 0.1s Trans.* Absolute Max Vin = 550V	15A Total	6A Total	5A Total

### Triple Output Converters

	3.3V/±12V (3R312T)	3.3V/±15V (3R315T)	5V/±12V (0512T)	5V/±15V (0515T)	30V/±15V (3015T)
<b>MQFL-28</b> 16-40Vin Cont. 16-50Vin 1s Trans.* Absolute Max Vin = 60V	22A/ ±1A	22A/ ±0.8A	15A/ ±1A	15A/ ±0.8A	2.5A/ ±0.8A
<b>MQFL-28E</b> 16-70Vin Cont. 16-80Vin 1s Trans.* Absolute Max Vin =100V	22A/ ±1A	22A/ ±0.8A	15A/ ±1A	15A/ ±0.8A	2.5A/ ±0.8A
<b>MQFL-28V</b> 16-40Vin Cont. 5.5-50Vin 1s Trans.* Absolute Max Vin = 60V	22A/ ±1A	22A/ ±0.8A	15A/ ±1A	15A/ ±0.8A	2.5A/ ±0.8A
<b>MQFL-28VE</b> 16-70Vin Cont. 5.5-80Vin 1s Trans.* Absolute Max Vin = 100V	22A/ ±1A	22A/ ±0.8A	15A/ ±1A	15A/ ±0.8A	2.5A/ ±0.8A
<b>MQFL-270</b> 155-400Vin Cont. 155-475Vin 0.1s Trans.* Absolute Max Vin = 550V	22A/ ±1A	22A/ ±0.8A	15A/ ±1A	15A/ ±0.8A	2.5A/ ±0.8A
<b>MQFL-270E</b> 130-475Vin Cont. 130-520Vin 0.1s Trans.* Absolute Max Vin = 600V	22A/ ±1A	22A/ ±0.8A	15A/ ±1A	15A/ ±0.8A	2.5A/ ±0.8A
<b>MQFL-270L</b> 65-350Vin Cont. 65-475Vin 0.1s Trans.* Absolute Max Vin = 550V	22A/ ±1A	22A/ ±0.8A	15A/ ±1A	15A/ ±0.8A	2.5A/ ±0.8A
(75W <sub>max</sub> Total Output Power)					

\*Converters may be operated continuously at the highest transient input voltage, but some component electrical and thermal stresses would be beyond MIL-HDBK-1547A guidelines.

†80% of total output current available on any one output.



# Technical Specification

**MQFL-28-28S**  
**Output: 28.0 V**  
**Current: 4 A**

## PART NUMBERING SYSTEM

The part numbering system for SynQor's *MilQor* DC/DC converters follows the format shown in the table below.

Model Name	Input Voltage Range	Output Voltage(s)			Package Outline/ Pin Configuration	Screening Grade
		Single Output	Dual Output	Triple Output		
MQFL	28	1R5S				
		1R8S				
		2R5S				
	28E	3R3S		3R312T	X	B
		05S				
	28V	06S	05D	3R315T	Y	C
		7R5S	12D	0512T	W	ES
	28VE	09S	15D	0515T	Z	HB
		12S		3015T		
	15S					
	270					
	270E					
	270L					
		28S				

**Example: MQFL - 28VE - 28S - Y - ES**

## APPLICATION NOTES

A variety of application notes and technical white papers can be downloaded in pdf format from the SynQor [website](#).

## PATENTS (additional patent applications may be filed)

SynQor holds the following patents, one or more of which might apply to this product:

5,999,417	6,222,742	6,545,890	6,577,109
6,594,159	6,731,520	6,894,468	6,896,526
6,927,987	7,050,309	7,072,190	7,085,146

## Contact SynQor for further information:

Phone: 978-849-0600  
Toll Free: 888-567-9596  
Fax: 978-849-0602  
E-mail: [power@synqor.com](mailto:power@synqor.com)  
Web: [www.synqor.com](http://www.synqor.com)  
Address: 155 Swanson Road  
 Boxborough, MA 01719  
 USA

### Warranty

SynQor offers a two (2) year limited warranty. Complete warranty information is listed on our [website](#) or is available upon request from SynQor.

Information furnished by SynQor is believed to be accurate and reliable. However, no responsibility is assumed by SynQor for its use, nor for any infringements of patents or other rights of third parties which may result from its use. No license is granted by implication or otherwise under any patent or patent rights of SynQor.