

Medical Grade AC-DC Power Supply With PFC

85-264 Vrms Input Voltage	12/15/24/28/48 V Semi-Regulated Output	800 W Output Continuous	1000 W Output Transient	Up to 93 % Full Load Efficiency
------------------------------	---	----------------------------	----------------------------	------------------------------------



Product Features

- High efficiency (93% for 48 VOUT Model at 800 W)
- Universal input voltage range
- Semi-regulated output for bus stability
- Integral fan cooling with speed control
- Active PFC; EN61000-3-2 compliant
- Low leakage; EN60601-1 compliant
- Low noise; EN55011 / EN55022 Class B compliant
- Medical EMI Compatibility:
IEC 60601-1-2 ed 4.0 compliant
- Over-current, over-voltage, & over-temp protection
- DC Power Good / AC Power Good signals
- Remote enable input
- Fan status output
- Small size: 4.75" x 7" x 1.625" (encased)
- RoHS 6/6 compliant
- 5 V (500 mW) standby output



Technical Specification

AC Input: 85-264 Vrms
 DC Output: 12/15/24/28/48 V Semi-reg.
 Power: 800 W
 Grade: Medical

ACuQor 800W Series Electrical Characteristics

All specifications typical with $T_A = 25\text{ }^\circ\text{C}$, unless otherwise specified. Specifications subject to change without notice.

MAIN OUTPUT SPECIFICATIONS

Output power (continuous) (5 s transient)	85-132/170-264 Vrms 85-132/170-264 Vrms 132-170 Vrms	800 W 1000 W See Figure 12
Nominal DC output voltage (at 800W) (Semi-regulated)	12 Vout 15 Vout 24 Vout 28 Vout 48 Vout	12.4 V 15.6 V 25 V 29 V 50 V
Efficiency (see figs. 1-10)	12 Vout, 115 Vrms, 800 W 24 Vout, 115 Vrms, 800 W 48 Vout, 115 Vrms, 800 W 12 Vout, 230 Vrms, 800 W 24 Vout, 230 Vrms, 800 W 48 Vout, 230 Vrms, 800 W	90% typ. 91% typ. 92% typ. 91% typ. 92% typ. 93% typ.
Hold-up time (to -20%)	12 /15 Vout 24 / 28 / 48 Vout	20 ms @ 800 W 24 ms @ 800 W
Maximum load capacitance	12 Vout 15 Vout 24 Vout 28 Vout 48 Vout	48,000 μF 40,500 μF 24,000 μF 19,200 μF 6,000 μF
Output ripple voltage	Switching frequency (20 MHz BW) Twice line frequency (at 800W)	0.5% p-p 5.0% p-p
Turn-on delay		2 s max.
Transient response	Iout steps from 50-75% At 0.2 A/ μs	3% typ / 6% max. dev. 100 ms recovery
Overvoltage protection	Cyclic restart	110-120%
Short circuit protection	Cyclic operation	115% rated Iout
Total regulation	Over line, load and temperature	$\pm 6.0\%$
Auxillary Output	Always on (See Note 1)	5 V @ 100 mA
Thermal protection	Automatic recovery	+125 $^\circ\text{C}$ (PCB Temp)
REMOTE_ENABLE	Input Low Voltage Input High Voltage	0.45 V (max) 4.15 V (min)

INPUT SPECIFICATIONS

AC input voltage	Universal range	85-264 Vrms
Input frequency		47-63 Hz
Input current	115 Vrms @ 800 W 230 Vrms @ 800 W	8 Arms 4 Arms
Power factor		>0.98
Input surge current	264 Vrms (cold start)	50 A max.
Internal input fuses	Both AC lines	20 A

GENERAL

Fundamental ripple freq.	Input Output	500 kHz 250 kHz
Audible noise	Fan speed varies with temp.	45 dBA @ 1 m max.
Weight (AQ0800xxxxGC)		998 g (35.2 oz)
(AQ1100xxxxGC)		1179 g (41.6 oz)
(AQ1400xxxxGC)		1179 g (41.6 oz)
MTBF	MIL-217 Demonstrated	533 kHours TBD kHours

ISOLATION

Isolation voltage	Input to output Input to ground Output to ground (BF & CF) Output to ground (CFD)	4000 Vrms 1500 Vrms 1500 Vrms 5000 Vpulse
Insulation resistance	Output to ground	10 M Ω min.
Leakage currents		See Note 2

ENVIRONMENTAL CHARACTERISTICS

Thermal performance	Operating ambient (see Fig 11) Non-operating ambient	0 $^\circ\text{C}$ to +70 $^\circ\text{C}$ -40 $^\circ\text{C}$ to +85 $^\circ\text{C}$
Relative humidity	Non-condensing	5-95% RH
Altitude	Operating Non-operating	10,000 ft max. 30,000 ft max.
Random vibration	5-500 Hz	0.03 g2/Hz
Shock	Half-sine, 10 ms, 3 axes	20 g peak

EMC CHARACTERISTICS

Conducted emissions	EN55011 and EN55022, FCC part15	Level B
Line frequency harmonics	EN61000-3-2	Class A
Voltage fluctuations	EN61000-3-3	Clause 5b
ESD air	EN61000-4-2	Level 4, +/-15kV
See following details		Perf Criteria A, AC Input Connections Perf Criteria B, DC Output Connections
ESD contact	EN61000-4-2	Level 4, +/-8kV Perf Criteria A; HCP, VCP, Case
Radiated immunity	EN61000-4-3	Level 3, 10V/m IEC60601-1-2 Ed.4 Table 4 28 V/m IEC60601-1-2 Ed.4 Table 9 Perf Criteria A
Fast transients	EN61000-4-4	Level 3, 100kHz rep, AC input leads IEC60601-1-2 Ed.4 Table 5 Perf Criteria A
Line surge immunity	EN61000-4-5	Level 3 Perf Criteria B
Conducted immunity	EN61000-4-6	Level 3 Perf Criteria A
Power freq. mag. field	EN61000-4-8	30 A/m IEC60601-1-2 Ed.4 Table 4 Perf Criteria A
Voltage dip immunity	EN61000-4-11	0% Ut; See following details 0.5 cycle 45 $^\circ$ increments 0% Ut; 1 cycle 70% Ut; 0.5s IEC60601-1-2 Ed.4 Table 5 Perf Criteria A, Load Dependent
Voltage interruptions	EN61000-4-11	0% Ut; 5s IEC60601-1-2 Ed.4 Table 5 Perf Criteria B

NOTES:

- Derate 1 mA per $^\circ\text{C}$ above 50 $^\circ\text{C}$ ambient temperature.
- Leakage currents see following table.



Technical Specification

AC Input: 85-264 Vrms
 DC Output: 12/15/24/28/48 V Semi-reg.
 Power: 800 W
 Grade: Medical

EMC Immunity Testing Details

ESD EN61000-4-2

For ESD tests applied directly to the DC output, one of the methods called out in IEC 61000-4-2 section 7.1.3 must be used to bleed off charge between successive ESD events. For example, the cable with 2 x 470kOhm resistors used for this purpose during coupling plane tests can be duplicated and connected from DC output to protective earth (PEGND). Discharges must not be applied directly to any circuits other than the case (for encased models), the AC input connections, and the DC output connections. For ESD protection in equipment, it is important to follow the ACuQor Installation Instructions provided with each unit in regards to clearance. Those instructions are repeated here for emphasis. CF and CFD models, in particular, may experience high DC output voltages with respect to protective earth (PEGND) due to their low capacitance/low-leakage design if ESD pulses are directly applied. Maintaining adequate clearance will prevent arcing from ACuQor DC output circuitry to other user circuits and chassis.

Voltage Dips EN61000-4-11

The following table details the DC output loading conditions and performance criteria for AC input voltage dip tests.

ACuQor 800/1100/1400W Performance

Test Condition	DC Load	Criteria
0% UT; 0.5 cycle at 0, 45, 90, 135, 180, 225, 270 and 315 degrees	0 to 1100 W > 1100 W	A B
0% UT; 1 cycle at 0 degrees	0 to 1000 W > 1000 W	A B
70% UT; 25/30 cycles (0.5s) at 0 degrees	0 to 1100 W >1100 W	A B
0% UT; 250/300 cycles (5s) at 0 degrees	All loading	B

Note: 800W models limited to 1100W transients

Leakage Currents

AC Leakage Current from Input to Earth	AC Line Connection	Normal Condition	Open Neutral Fault
ACuQor Typical at 110% nominal input voltage 60 Hz	240 V L-N, 1 phase	220 µA	440 µA
	208 V L-L, 120 V L-N, 1 of 3 phases	120 µA	240 µA
	240 V L-N-L, 120 V L-N, split phase	120 µA	240 µA

AC Leakage Current from Output to Earth	Model	Normal Condition	Open Earth Fault	AC Backdrive Fault
ACuQor Typical at 264 Vac 60 Hz input	AQ . . BF . .	4 µA	40 µA	78 µA
	AQ . . CF . .	4 µA	20 µA	39 µA

For convenience, the following tables show limits allowed by various standards:

AC Leakage Current from Input to Earth	Standard	Normal Condition	Open Neutral Fault
Maximum Allowed per Standard	IEC60601-1	500 µA	1000 µA
	NFPA 99 2005	300 µA	—
	IEC60950	3500 µA	—

AC Leakage Current from Output to Earth	Contact Type	Normal Condition	Open Earth Fault	AC Backdrive Fault
Maximum Allowed per IEC60601-1	BF	100 µA	500 µA	5000 µA
	CF	10 µA	50 µA	50 µA

Table 1: Leakage Currents

Standard Testing Certifications

SAFETY AGENCY CERTIFICATIONS

- UL 60601-1
- CAN/CSA C22.2 No. 601.1-M90
- EN 60601-1
- IEC 60601-1
- ANSI/AAMI ES60601-1
- CE Marked
- Meets NFPA 99 2005 300 µA earth leakage

CONNECTOR DETAILS

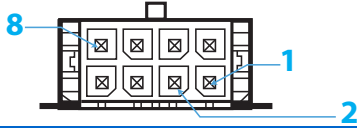

OUTPUT CONNECTOR PINOUT

Pin 1	Reserved	Reserved for future use.
Pin 2	Reserved	Reserved for future use.
Pin 3	VOUT(-)	Negative Output Voltage.
Pin 4	REMOTE_ENABLE	Logic input. See Figure B. Pull high to enable main output.
Pin 5	FAN_GOOD	Open collector with internal 5 V pullup. See Figure A. Pulsed low on fan failure, 100 ms, 50% duty
Pin 6	AC_POWER_GOOD	Open collector with internal 5 V pullup. See Figure A. Pulsed low on AC power dropout.
Pin 7	DC_POWER_GOOD	Open collector with internal 5 V pullup. See Figure A. Pulsed low during startup ramp and within 5°C of temperature shutdown threshold.
Pin 8	5V_STANDBY	5 V @ 100 mA available whenever AC power is applied.

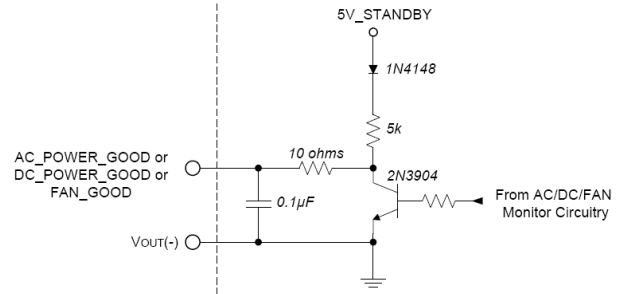

Figure A: Power good and fan good interface circuitry.

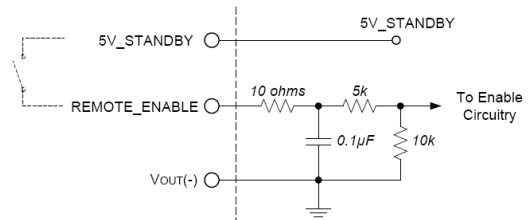
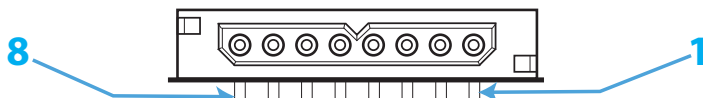

Figure B: Remote enable interface circuitry



OUTPUT CONNECTOR PINOUT

Pin 1	VOUT(+)	Positive Output Voltage.
Pin 2	VOUT(-)	Negative Output Voltage.
Pin 3	VOUT(+)	Positive Output Voltage.
Pin 4	VOUT(-)	Negative Output Voltage.
Pin 5	VOUT(+)	Positive Output Voltage.
Pin 6	VOUT(-)	Negative Output Voltage.
Pin 7	VOUT(+)	Positive Output Voltage.
Pin 8	VOUT(-)	Negative Output Voltage.



INDIVIDUAL INPUT CONNECTOR PINOUT

Pin 1	Ground
Pin 2	AC Neutral
Pin 3	AC Line

MATING CONNECTORS

Connector	Type	Contact
OUTPUT (Power)	Positronic PLA08M7	Positronic MS112N
OUTPUT (Data)	Molex 43025-0810	Molex 430300008
INPUT	Hirose DF22B-3S-7.92C	Hirose DF22A-1012SCA



AC Input: 85-264 Vrms
 DC Output: 12/15/24/28/48 V Semi-reg.
 Power: 800 W
 Grade: Medical

Technical Specification

EFFICIENCY, DERATING, AND VOUT DROOP CURVES

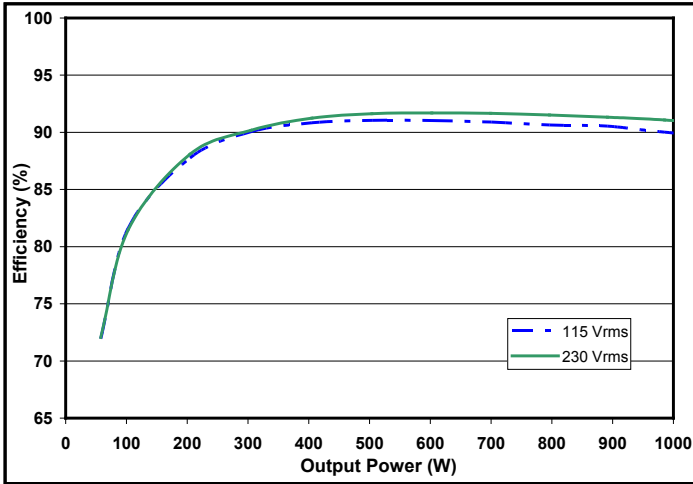

Figure 1: 12 V_{OUT} efficiency curves.

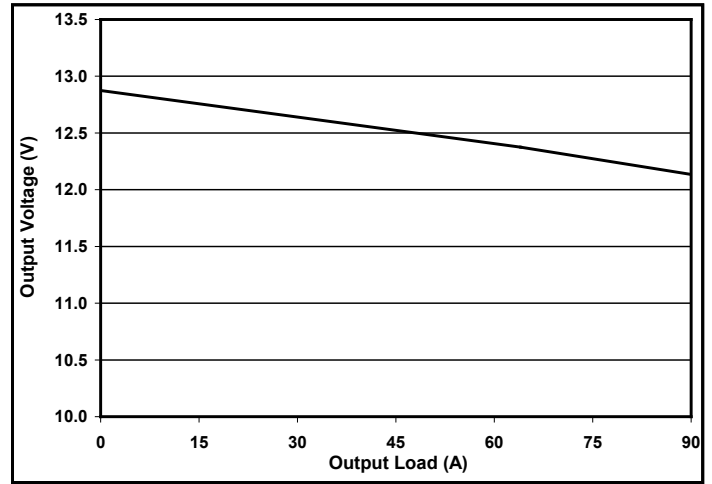

Figure 2: 12 V_{OUT} droop characteristic.

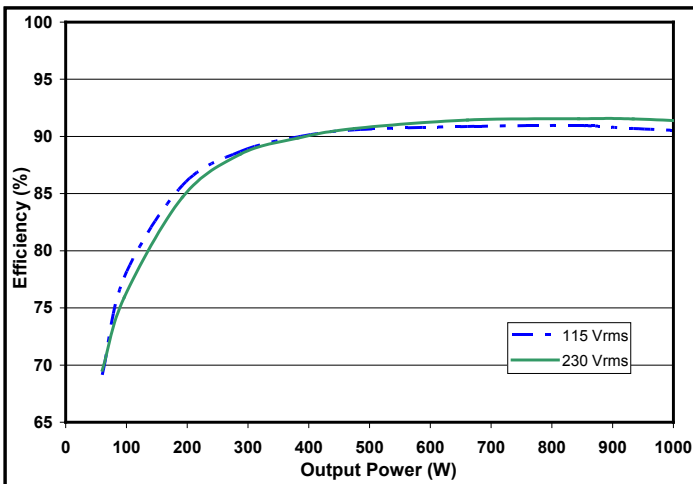

Figure 3: 15 V_{OUT} efficiency curves.

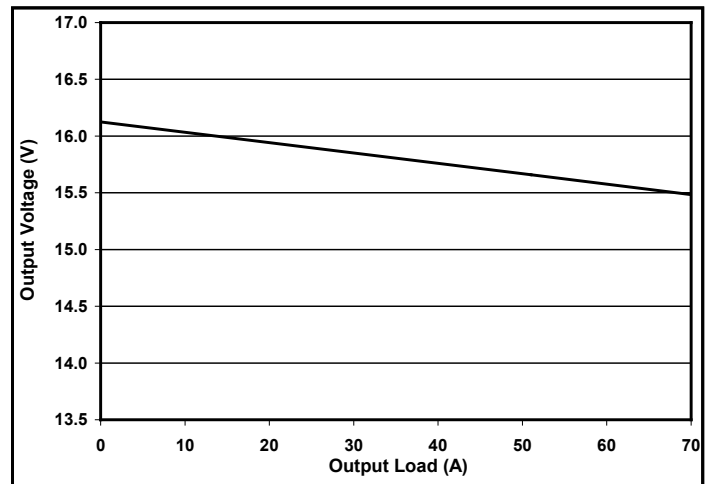

Figure 4: 15 V_{OUT} droop characteristic.

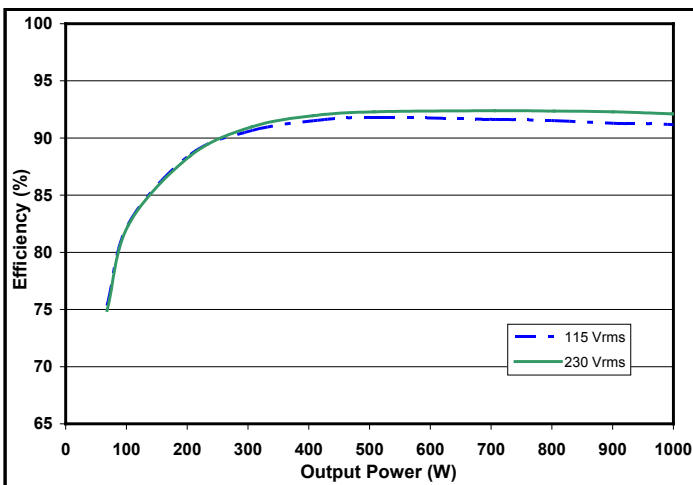

Figure 5: 24 V_{OUT} efficiency curves.

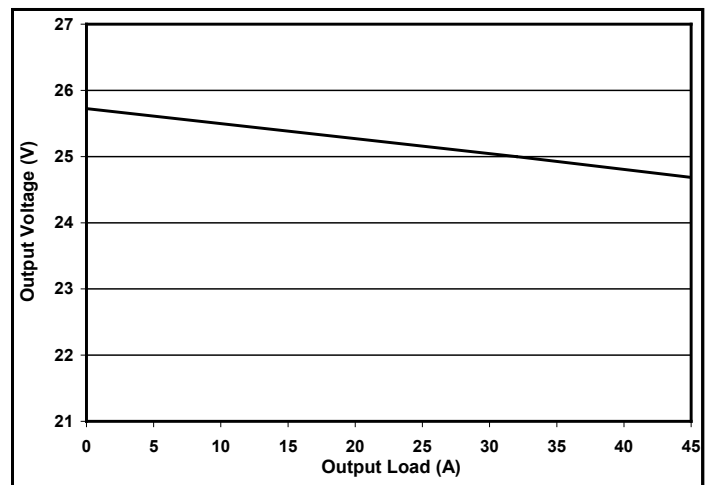

Figure 6: 24 V_{OUT} droop characteristic.



EFFICIENCY, DERATING, AND VOUT DROOP CURVES

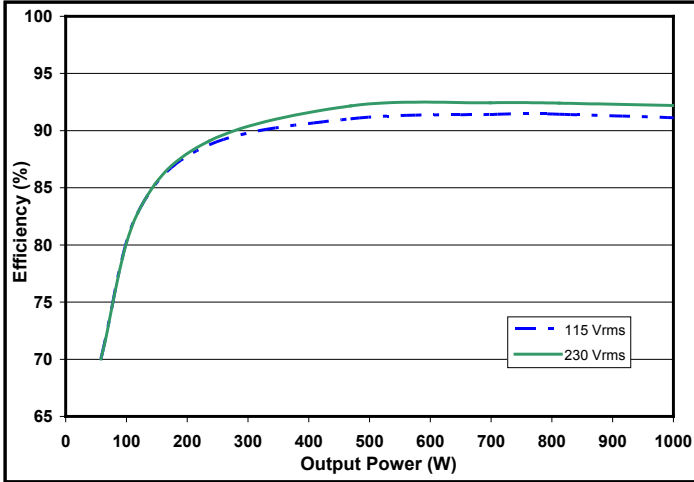

Figure 7: 28 V_{OUT} efficiency curves.

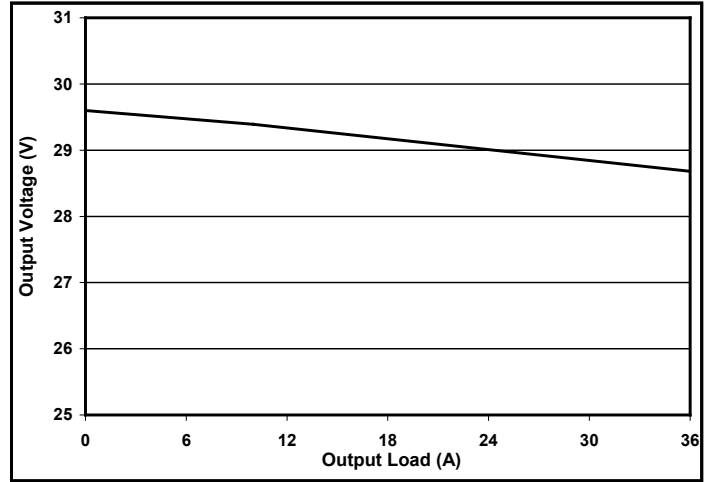

Figure 8: 28 V_{OUT} droop characteristic.

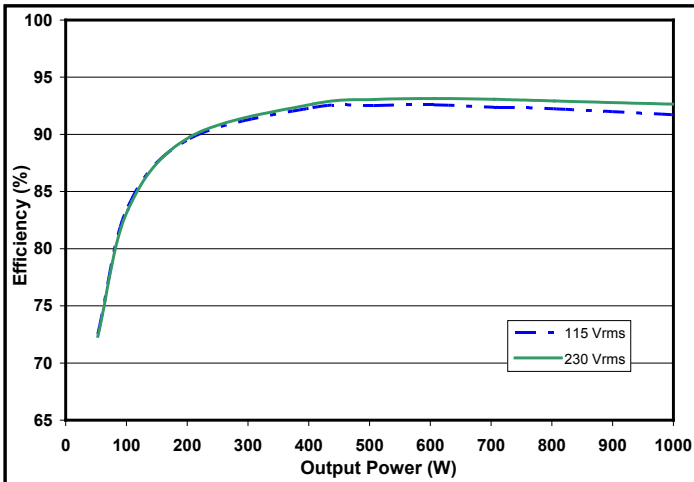

Figure 9: 48 V_{OUT} efficiency curves.

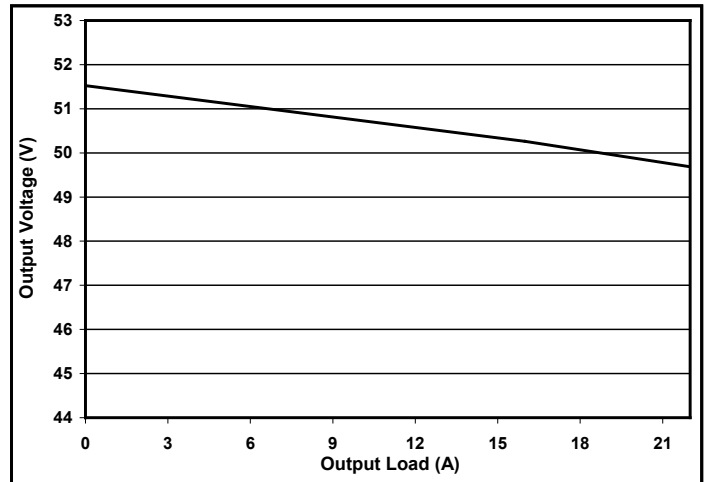

Figure 10: 48 V_{OUT} droop characteristic.

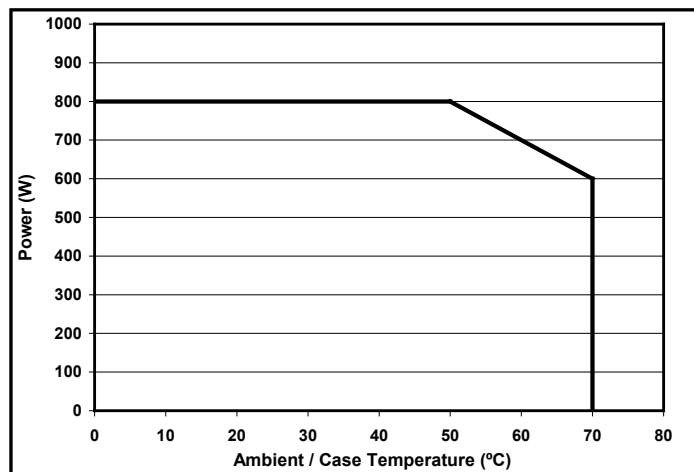

Figure 11: Continuous power derating curve in natural convection.

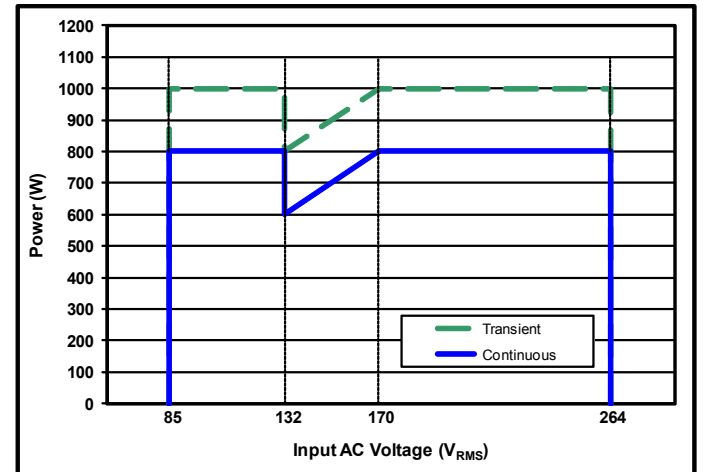
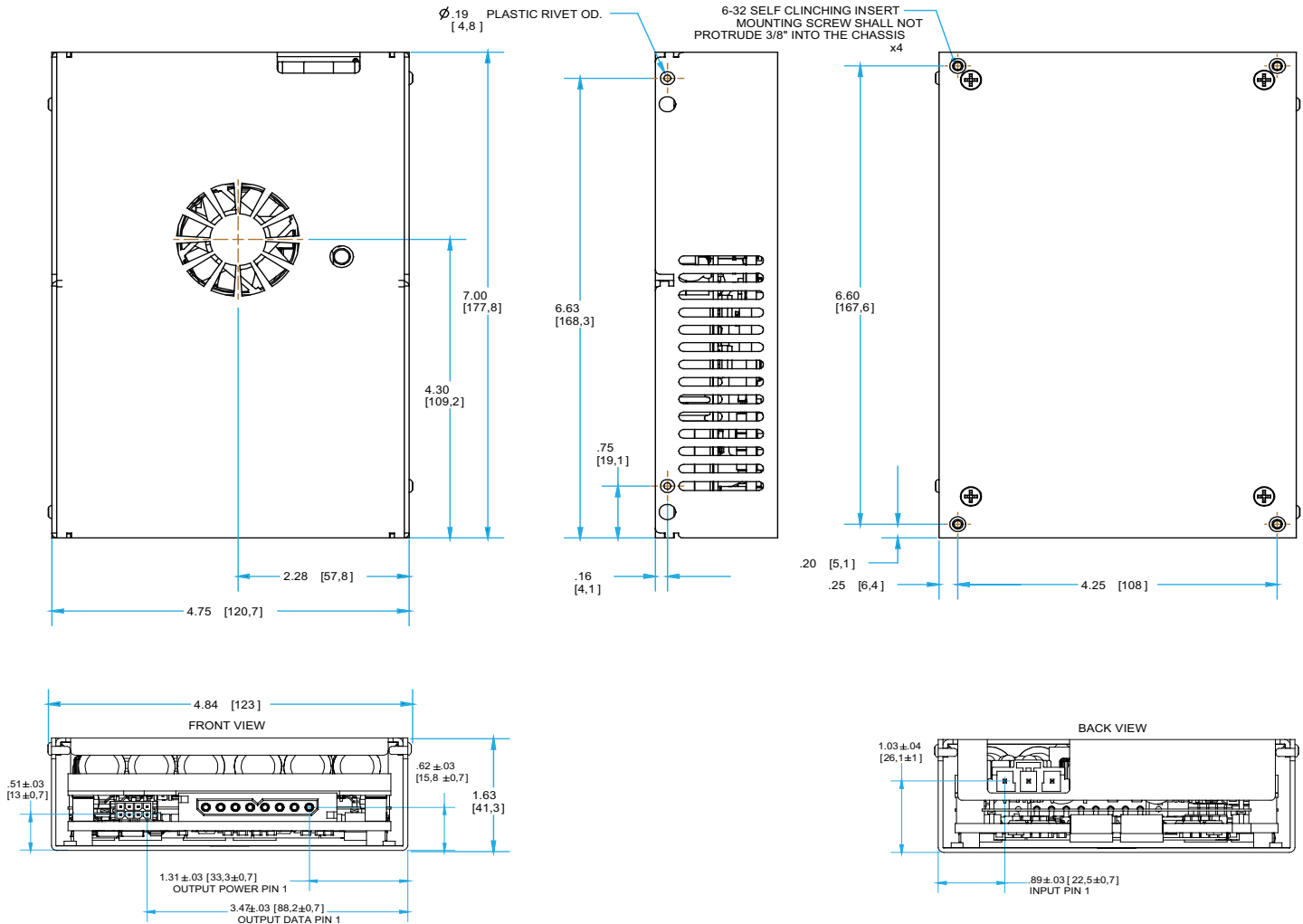

Figure 12: Rated output power vs Input AC Voltage.

MECHANICAL DRAWINGS



NOTES

1. Recommended screw tightening torque of 6in.. lbs.
2. Undimensioned components are shown for visual reference only
3. All dimensions in inches [mm]
 Tolerances: x.xx in ± 0.02
 x.xxx in ± 0.010



AC Input: 85-264 Vrms
 DC Output: 12/15/24/28/48 V Semi-reg.
 Power: 800 W
 Grade: Medical

INSTALLATION INSTRUCTIONS

GENERAL: ACuQor power supplies are intended for use as components in medical and industrial equipment. ACuQor units must be properly installed within end use equipment before they can be safely applied as described in this document. The suitability of the ACuQor/equipment combination must be verified through end product investigation.

MOUNTING: Refer to the Mechanical Drawings section. ACuQor units are provided with threaded stainless-steel stand-offs or inserts for mounting. This mounting hardware is internally connected to the input connector protective-earth terminal for functional-earth EMC control. Any orientation (vertical, horizontal, etc.) may be used. Adequate air space should be provided over the fan intake (top) and exhaust (sides) to allow for exchange of cooling air. ACuQor is designed for a pollution degree 2 environment. A minimum of 5 mm electrical clearance should be allowed from the connector ends of encased models.

INPUT: Refer to the Connector Details section for input connector wiring. ACuQor products require a single phase AC power source of 100-240V 50/60Hz nominal. Refer to nameplate label for input current ratings. A protective-earth connection is also required. Minimum wire size of 14 AWG (2.5mm²) is recommended. Both sides of the AC line are internally fused (see table for specific models). These fuses are not user replaceable.

OUTPUT: Refer to the Connector Details section for output connector wiring and signal I/O functionality. Refer to nameplate label for output current ratings. Main DC output (Vout+, Vout-) pins should use 12 AWG (4.0mm²) wire size. Individual main output pins should not be loaded to more than 30 A. For currents greater than 30 A, multiple main output pins/wires must be used in parallel. All signal I/O pins are referenced to Vout-.

EMC: ACuQor products have been tested to the EMC specifications listed in the section of this datasheet titled Electrical Characteristics, on page two. However, end use equipment must be tested to verify EMC compliance.

PATIENT CONTACT: ACuQor models include versions designed for B, BF and CF patient contact application per IEC60601-1. The BF and CF ACuQor models provide reinforced insulation at the DC output voltage level and basic insulation at the 240 Vac level from output to protective-earth. Note that equipment and wiring may add to system leakage currents so that the end product must be tested for compliance. Refer to the Electrical Characteristics section for typical ACuQor input and output leakage currents. In addition, ACuQor defibrillation rated models comply with the minimum output to protective-earth creepage/clearance requirement and defibrillator pulse test of IEC60601-1.

HIPOT TESTING: ACuQor products are rated for Hipot testing levels of 1500 Vac input to protective-earth, 1500 Vac output to protective-earth, and 4000 Vac input to output. When performing the 4000 Vac input to output test, the test voltage must be balanced evenly 2000 Vac input and output to protective-earth. Two oppositely phased test voltage sources or a single test voltage source with external balancing impedances (capacitors) may be used to prevent overstressing input or output to protective-earth insulation per IEC60601-1 2005 sub clause 8.8.1 and IEC60601-1 1990 sub clause 20.4.

MODEL	Input Fuses (in Both AC Lines)
AQ0800	Cooper Bussmann 20A 250V GBB-20
AQ1100	Cooper Bussmann 20A 250V GBB-20
AQ1400	Cooper Bussmann 20A 250V GBB-20



PART NUMBERING SYSTEM

The part numbering system for SynQor’s ACuQor AC/DC power supplies follows the format shown in the table below. Not all combinations make valid part numbers, please contact SynQor for availability.

Family	Output Power	Grade	Range	Output Voltage	Package Type	Thermal Design	Options
AQ: ACuQor series of AC-DC semi-regulated output power supplies	0800: 800 W 1100: 1100 W 1400: 1400 W	M: (Medical)	4: 4th Generation EMC Universal (85-264 VRMS)	12: 12 V 15: 15 V 24: 24 V 28: 28 V 48: 48 V	G: (5"x7")	C: Encased	Medical Grade: BF: BF isolation rating CF: CF isolation rating CFD: CF isolation rating defibrillator proof

Example: AQ0800M424GCCFD

ACCESSORIES

SynQor offers a series of assemblies that can be ordered according to the table below. Mechanical drawings for these accessories are available for download in pdf format from the SynQor website.

Part Number	Description
AQ-CBL-INPUT1CG	Input mating cable with pre-stripped wire ends (36" long).
AQ-CBL-OUT1CDG	Output mating cables with pre-stripped wire ends (18" long).

APPLICATION NOTES

A variety of application notes and technical white papers can be downloaded in pdf format from the SynQor website.

- [Online Application Notes](#)
- [Online Library of Technical White Papers](#)
- [SynQor website.](#)

Contact SynQor for further information and to order:

Phone: 978-849-0600 Toll Free: 888-567-9596 Fax: 978-849-0602

E-mail: power@synqor.com Web: www.synqor.com

Address: 155 Swanson Road, Boxborough, MA 01719 USA

WARRANTY

SynQor offers a two (2) year limited warranty. Complete warranty information is listed on our website or is available upon request from SynQor.

PATENTS

SynQor holds numerous U.S. patents, one or more of which apply to most of its power conversion products. Any that apply to the product(s) listed in this document are identified by markings on the product(s) or on internal components of the product(s) in accordance with U.S. patent laws. SynQor’s patents include the following:

- 7,050,309 7,765,687 7,787,261
- 8,149,597 8,644,027