

<b>9-75 V</b> Continuous Input	<b>100 V</b> Transient Input	<b>5.0-50 V</b> Outputs	<b>255 W</b> Max Power	<b>2250 Vdc</b> Isolation	<b>Half-brick</b> DC-DC Converter
-----------------------------------	---------------------------------	----------------------------	---------------------------	------------------------------	--------------------------------------



The InQor® Half-brick Zeta converter series is composed of next-generation, board-mountable, fixed switching frequency dc-dc converters that use synchronous rectification to achieve extremely high power conversion efficiency. Each module is supplied completely encased to provide protection from the harsh environments seen in many industrial and transportation applications.

### Operational Features

- High efficiency, up to 92% at full rated load current
- Operating input voltage range: 9-75 V
- Fixed frequency switching provides predictable EMI
- No minimum load requirement
- Optional: Active current share for parallel applications

### Mechanical Features

- Industry standard Half-brick pin-out
- Size: 2.386" x 2.486" x 0.512" (60.60 x 63.14 x 13.00 mm)
- Total weight: 4.9 oz (138 g)
- Flanged baseplate version available

### Control Features

- On/Off control referenced to input side
- Remote sense for improved output voltage control
- Extended Output Voltage Trim Range

### Safety Features

- UL 60950-1 Basic Insulation
- CAN/CSA-C22.2 No. 60950-1
- EN 60950-1
- RoHS compliant (see last page)

### Protection Features

- Input under-voltage lockout
- Output current limit and short circuit protection
- Active back drive current limit
- Auto-recovery output over-voltage protection
- Thermal shutdown

### CONTENTS

Family Electrical Characteristics . . . . .	2
Electrical Characteristics (5.0 Vout) & Figures . . . . .	4
Electrical Characteristics (12 Vout) & Figures . . . . .	6
Electrical Characteristics (15 Vout) & Figures . . . . .	8
Electrical Characteristics (24 Vout) & Figures . . . . .	10
Electrical Characteristics (28 Vout) & Figures . . . . .	12
Electrical Characteristics (40 Vout) & Figures . . . . .	14
Electrical Characteristics (50 Vout) & Figures . . . . .	16
Application Section . . . . .	18
Standards & Qualification Testing . . . . .	24
Standard Mechanical Diagram . . . . .	25
Flanged Mechanical Diagram . . . . .	26
Ordering Information . . . . .	27

### IQ32 FAMILY ELECTRICAL CHARACTERISTICS (all output voltages)

Ta = 25 °C, airflow rate = 300 LFM, Vin = 32 Vdc unless otherwise noted; full operating temperature range is -40 °C to +100 °C baseplate temperature with appropriate power derating. Specifications subject to change without notice.

Parameter	Min.	Typ.	Max.	Units	Notes & Conditions
<b>ABSOLUTE MAXIMUM RATINGS</b>					
Input Voltage					
Non-Operating	-1		100	V	Continuous
Operating			75	V	Continuous
Operating Transient			100	V	1 s transient, square wave
Isolation Voltage					
Input to Output			2250	Vdc	
Input to Baseplate			2250	Vdc	
Output to Baseplate			2250	Vdc	
Operating Temperature	-40		100	°C	Baseplate temperature
Storage Temperature	-45		125	°C	
Voltage at ON/OFF input pin	-2		18	V	
<b>INPUT CHARACTERISTICS</b>					
Operating Input Voltage Range	9	32	75	V	
Input Under-Voltage Lockout					
Turn-On Voltage Threshold	9.4	10.1	10.8	V	See Note 2
Turn-Off Voltage Threshold	7.6	8.3	9.0	V	
Lockout Voltage Hysteresis		1.8		V	
Input Over-Voltage Shutdown		-		V	Not Available
Recommended External Input Capacitance		470		µF	Typical ESR 0.1-0.2 Ω; see Note 4
Input Filter Component Values (Ln\Cs)		0.34\11		µH\µF	Internal values; see Figure D
<b>DYNAMIC CHARACTERISTICS</b>					
Turn-On Transient					
Turn-On Time		50		ms	Full load, Vout=90% nom.(from enable); See Note 3
Output Voltage Overshoot		3		%	
Auto-Recovery Startup Inhibit Time		500		ms	See Application Section
<b>ISOLATION CHARACTERISTICS</b>					
Isolation Voltage (dielectric strength)					See Absolute Maximum Ratings
Isolation Resistance		30		MΩ	
Isolation Capacitance (input to output)		1000		pF	See Note 1
<b>TEMPERATURE LIMITS FOR POWER DERATING CURVES</b>					
Semiconductor Junction Temperature			125	°C	Package rated to 150 °C
PCB Temperature			125	°C	UL rated max operating temp 130 °C
Transformer Temperature			125	°C	
Maximum Baseplate Temperature, Tb			100	°C	
<b>FEATURE CHARACTERISTICS</b>					
Switching Frequency	230	240	250	kHz	Isolation stage switching freq. is 1/4 this
ON/OFF Control					
Off-State Voltage	2.4		18.0	V	
On-State Voltage	-2.0		0.8		
ON/OFF Control					Application notes Figure A
Pull-Up Voltage		15	18	V	
Pull-Up Resistance		50		kΩ	
Over-Temperature Shutdown OTP Trip Point		125		°C	Average PCB Temperature
Over-Temperature Shutdown Restart Hysteresis		10		°C	
<b>RELIABILITY CHARACTERISTICS</b>					
Calculated MTBF (Telcordia) TR-NWT-000332		1.44		10 <sup>6</sup> Hrs.	Tb = 70 °C
Calculated MTBF (MIL-217) MIL-HDBK-217F		1.2		10 <sup>6</sup> Hrs.	Tb = 70 °C

Note 1: Higher values of isolation capacitance can be added externally to the module

Note 2: After passing turn-on voltage, unit will operate down to turn-off voltage threshold

Note 3: Add 25 ms to Turn-On time for full-featured units to allow for synchronization

Note 4: See "Input System Instability" in the Application Considerations section.

### Family Figures (all output voltages)

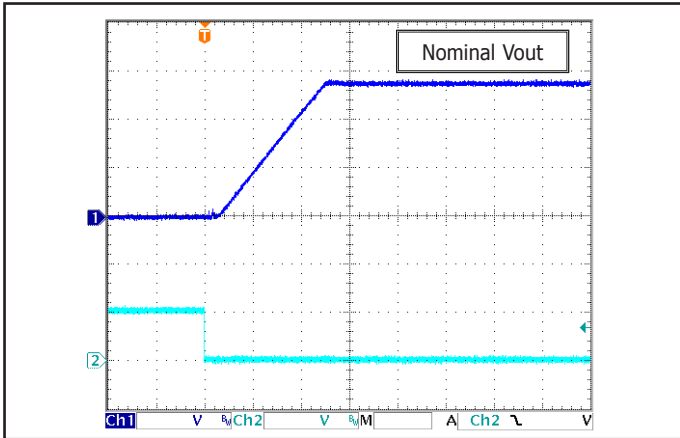

Common Figure 1: Startup Waveform (typical). Input voltage pre-applied, ON/OFF Pin on Ch 2. Output voltage normalized.

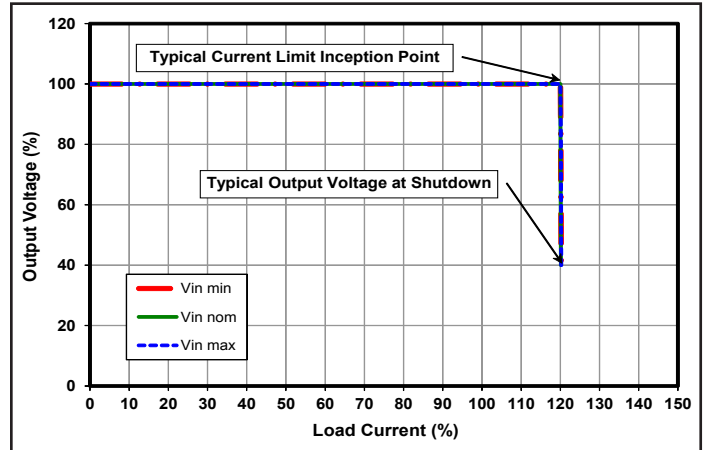

Common Figure 2: Output I-V Characteristics (output voltage vs. load current) showing typical current limit curves and converter shutdown points.

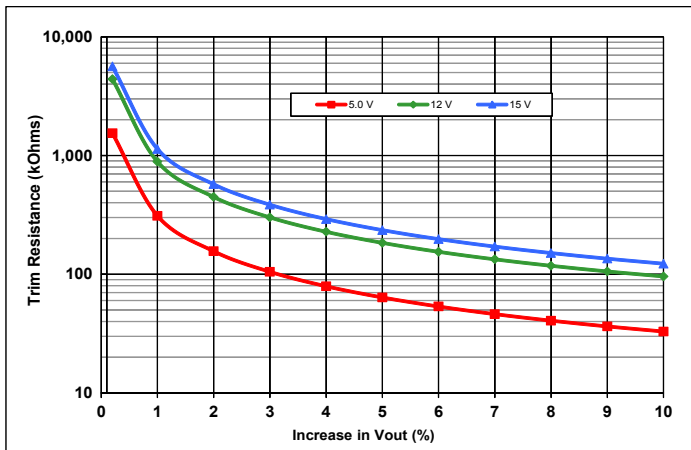

Common Figure 3: Trim-Up Graph for 5.0 to 15 V outputs.

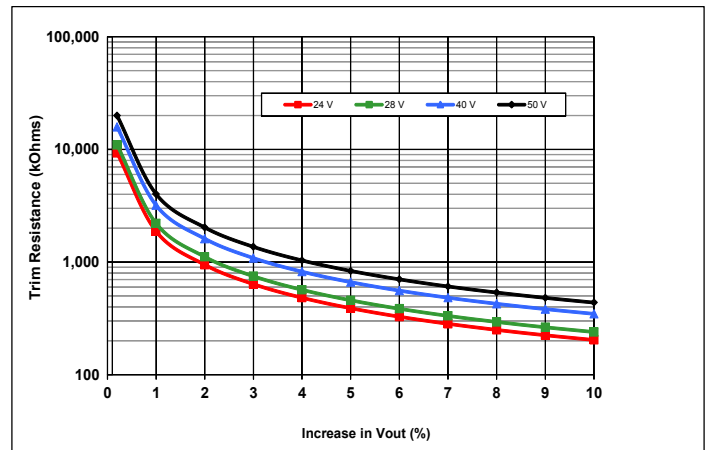

Common Figure 4: Trim-Up Graph for 24 to 50 V outputs.

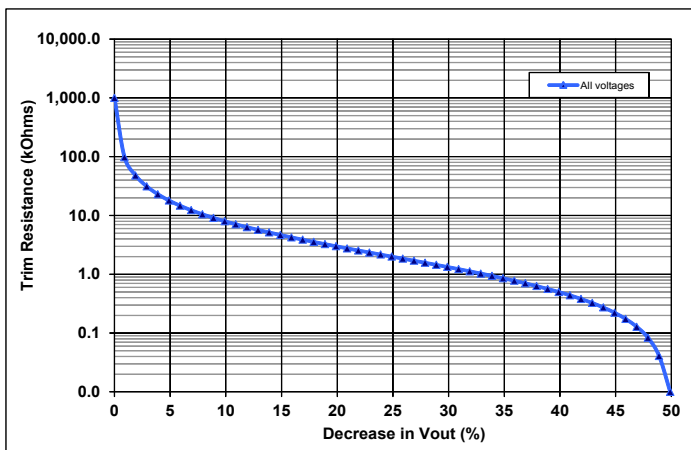

Common Figure 5: Trim-Down Graph for all outputs.

## IQ32050HZx50 ELECTRICAL CHARACTERISTICS (5.0 Vout)

Ta = 25 °C, airflow rate = 300 LFM, Vin = 32 Vdc unless otherwise noted; full operating temperature range is -40 °C to +100 °C baseplate temperature with appropriate power derating. Specifications subject to change without notice.

Parameter	Min.	Typ.	Max.	Units	Notes & Conditions
<b>INPUT CHARACTERISTICS</b>					
Maximum Input Current			35	A	100 % Load, 9V Vin, trimmed up 10 %
No-Load Input Current (enabled)		450	560	mA	
Disabled Input Current		5	8	mA	
Response to Input Transient		1.1		V	See Figure 6
Input Terminal Ripple Current		1.6		A	RMS
Recommended Input Fuse			50	A	Fast acting fuse recommended; see Note 4
<b>OUTPUT CHARACTERISTICS</b>					
Output Voltage Set Point	4.920	5.000	5.070	V	
Output Voltage Regulation					See Note 3
Over Line		±0.25		%	
Over Load		±0.25		%	
Over Temperature	-120		120	mV	
Total Output Voltage Range	4.850		5.150	V	Over sample, line, load, temperature & life
Output Voltage Ripple and Noise					20 MHz bandwidth; see Note 1
Peak-to-Peak		100	200	mV	Full load
RMS		16	30	mV	Full load
Operating Output Current Range	0		50	A	Subject to thermal derating
Output DC Current Limit Inception	56.0	63.0	70.0	A	Output voltage 10 % Low
Output DC Current Limit Shutdown Voltage		2.0		V	See Note 2
Back-Drive Current Limit while Enabled		5		A	Negative current drawn into output pins
Back-Drive Current Limit while Disabled		3	6	mA	Negative current drawn into output pins
Maximum Output Capacitance			10000	µF	Vout nominal at full load (resistive load)
Output Voltage during Load Current Transient					
Step Change in Output Current (0.1 A/µs)		200		mV	50 % to 75 % to 50 % Iout max; see Figure 5
Settling Time		6		ms	To within 1 % Vout nom; see Figure 5
Output Voltage Trim Range	-50		10	%	Across Pins 8 & 4; Common Figures 3-5
Output Voltage Remote Sense Range			10	%	Across Pins 8 & 4
Output Over-Voltage Protection	6.1	6.3	6.5	V	Over full temp range
<b>EFFICIENCY</b>					
100 % Load		89		%	See Figure 1 for efficiency curve
50 % Load		87		%	See Figure 1 for efficiency curve

Note 1: Output is terminated with 1 µF ceramic and 15 µF low-ESR tantalum capacitors. For applications requiring reduced output voltage ripple and noise, consult SynQor applications support (e-mail: support@synqor.com)

Note 2: If the output voltage falls below the Output DC Current Limit Shutdown Voltage for more than 50 ms, then the unit will enter into hiccup mode, with a 500 ms off-time

Note 3: Line and load regulation is limited by duty cycle quantization and does not indicate a shift in the internal voltage reference

Note 4: Safety certification requires the use of a fuse rated at or below this value.

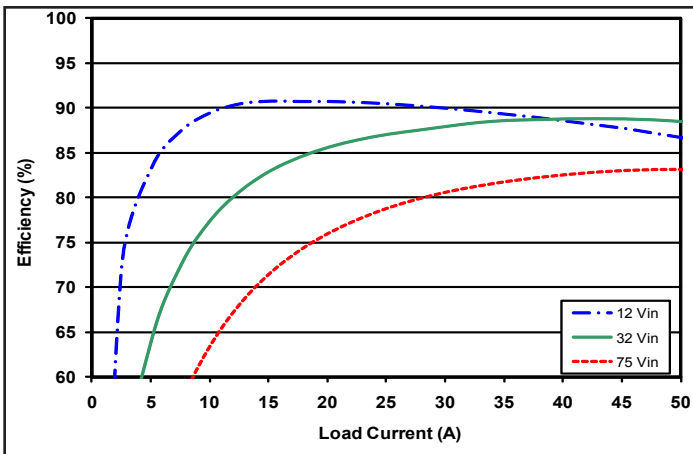

Figure 1: Efficiency at nominal output voltage vs. load current for minimum, nominal, and maximum input voltage at 25 °C.

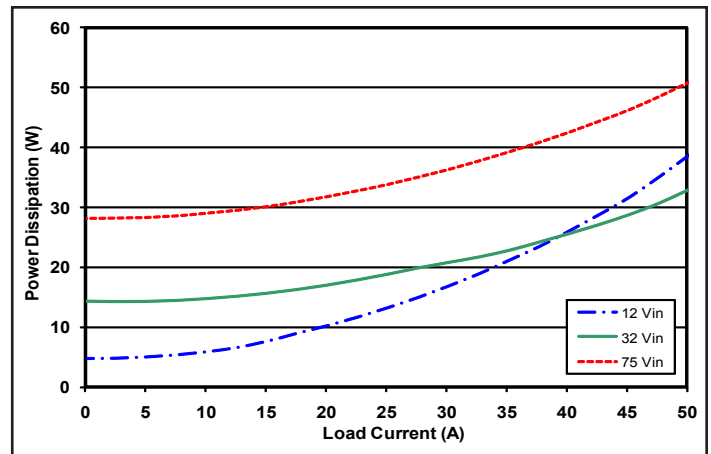

Figure 2: Power Dissipation at nominal output voltage vs. load current for minimum, nominal, and maximum input voltage at 25 °C.

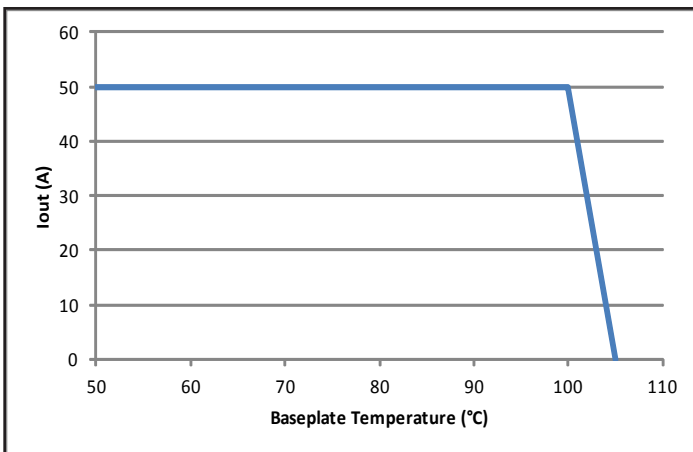

Figure 3: Maximum load current vs. baseplate temperature when conductively cooled. Note: The system design must provide a suitable thermal path that maintains the baseplate temperature below 100 °C.

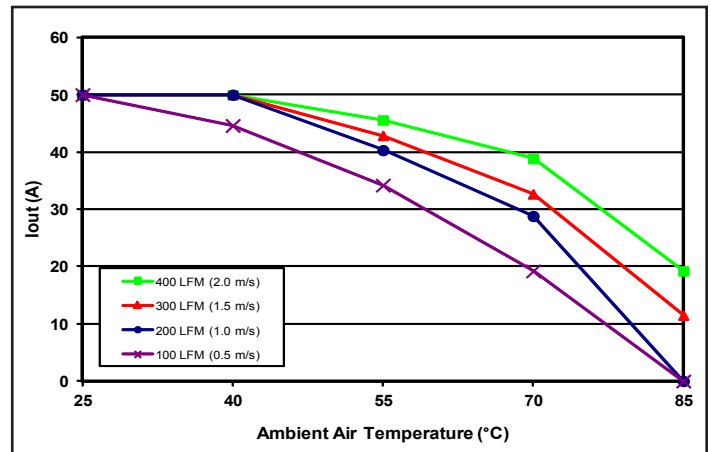

Figure 4: Thermal Derating (max output current vs. ambient air temperature) for encased converter with 1/2" heatsink, at airflow rates of 100 LFM through 400 LFM. Air flows across the converter from input to output (nominal input voltage).

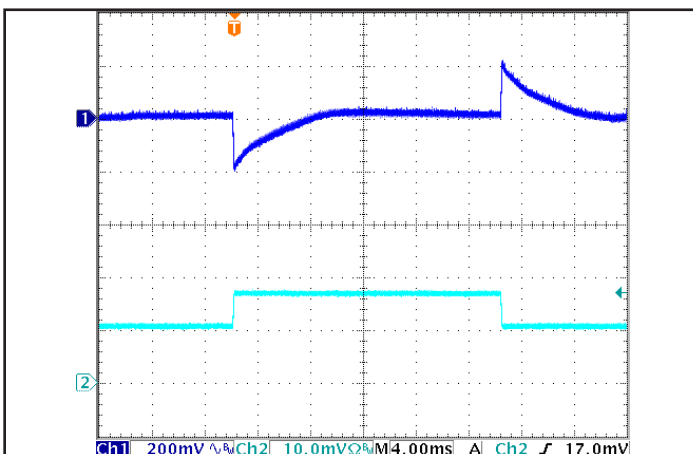

Figure 5: Output Voltage Response to Step-Change in Load Current (50% -75% -50% of I<sub>out</sub>(max); dI/dt = 0.1 A/μs). Load cap: 15 μF tantalum cap and 1 μF ceramic cap. Ch 1: V<sub>out</sub> (200 mV/div), Ch 2: I<sub>out</sub> (20.0 A/div). Timescale: 4.00 ms/div.

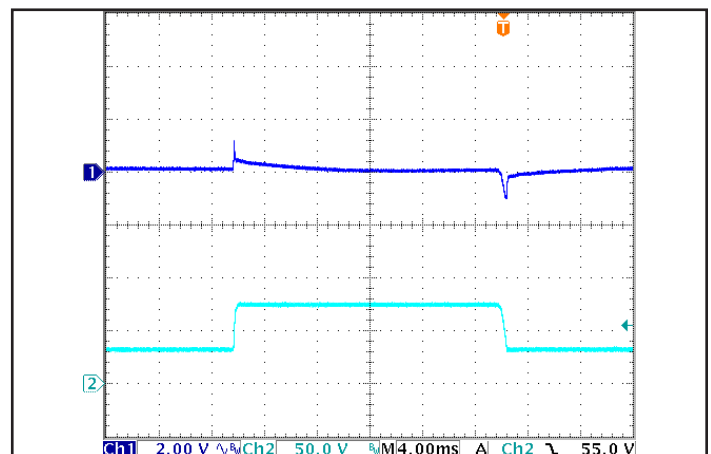

Figure 6: Output Voltage Response to Step-Change in Input Voltage (250 V/ms), at Max. load current. Load cap: 330 μF electrolytic cap and 1 μF ceramic cap. Ch 1: V<sub>out</sub> (2.00 V/div), Ch 2: V<sub>in</sub> (50.0 V/div). Timescale: 4.00 ms/div.

## IQ32120HZx21 ELECTRICAL CHARACTERISTICS (12.0 Vout)

Ta = 25 °C, airflow rate = 300 LFM, Vin = 32 Vdc unless otherwise noted; full operating temperature range is -40 °C to +100 °C baseplate temperature with appropriate power derating. Specifications subject to change without notice.

Parameter	Min.	Typ.	Max.	Units	Notes & Conditions
<b>INPUT CHARACTERISTICS</b>					
Maximum Input Current			35	A	100 % Load, 9V Vin, trimmed up 10 %
No-Load Input Current (enabled)		420	525	mA	
Disabled Input Current		5	8	mA	
Response to Input Transient		2.8		V	See Figure 6
Input Terminal Ripple Current		1.8		A	RMS
Recommended Input Fuse			50	A	Fast acting fuse recommended; see Note 4
<b>OUTPUT CHARACTERISTICS</b>					
Output Voltage Set Point	11.80	12.00	12.17	V	
Output Voltage Regulation					See Note 3
Over Line		±0.25		%	
Over Load		±0.25		%	
Over Temperature	-300		300	mV	
Total Output Voltage Range	11.64		12.36	V	Over sample, line, load, temperature & life
Output Voltage Ripple and Noise					20 MHz bandwidth; see Note 1
Peak-to-Peak		100	200	mV	Full load
RMS		10	20	mV	Full load
Operating Output Current Range	0		21	A	Subject to thermal derating
Output DC Current Limit Inception	24.3	27.0	29.7	A	Output voltage 10 % Low
Output DC Current Limit Shutdown Voltage		4.8		V	See Note 2
Back-Drive Current Limit while Enabled		8		A	Negative current drawn into output pins
Back-Drive Current Limit while Disabled		3	6	mA	Negative current drawn into output pins
Maximum Output Capacitance			6000	µF	Vout nominal at full load (resistive load)
Output Voltage during Load Current Transient					
Step Change in Output Current (0.1 A/µs)		500		mV	50 % to 75 % to 50 % Iout max; see Figure 5
Settling Time		1.5		ms	To within 1 % Vout nom; see Figure 5
Output Voltage Trim Range	-50		10	%	Across Pins 8 & 4; Common Figures 3-5
Output Voltage Remote Sense Range			10	%	Across Pins 8 & 4
Output Over-Voltage Protection	14.4	15.0	15.6	V	Over full temp range
<b>EFFICIENCY</b>					
100 % Load		90		%	See Figure 1 for efficiency curve
50 % Load		89		%	See Figure 1 for efficiency curve

Note 1: Output is terminated with 1 µF ceramic and 15 µF low-ESR tantalum capacitors. For applications requiring reduced output voltage ripple and noise, consult SynQor applications support (e-mail: support@synqor.com)

Note 2: If the output voltage falls below the Output DC Current Limit Shutdown Voltage for more than 50 ms, then the unit will enter into hiccup mode, with a 500 ms off-time

Note 3: Line and load regulation is limited by duty cycle quantization and does not indicate a shift in the internal voltage reference

Note 4: Safety certification requires the use of a fuse rated at or below this value.

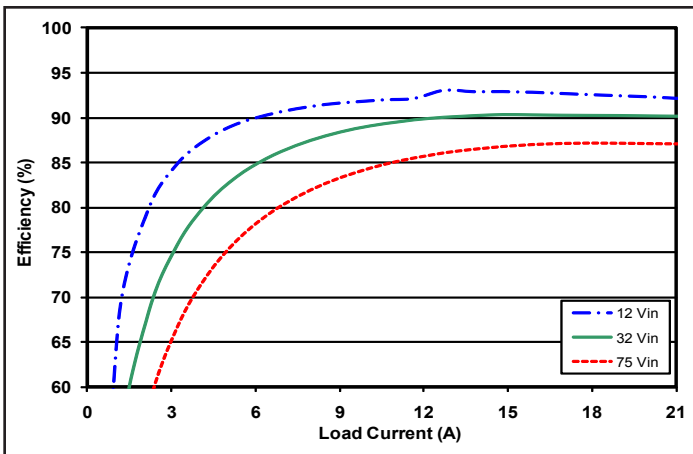

Figure 1: Efficiency at nominal output voltage vs. load current for minimum, nominal, and maximum input voltage at 25 °C.

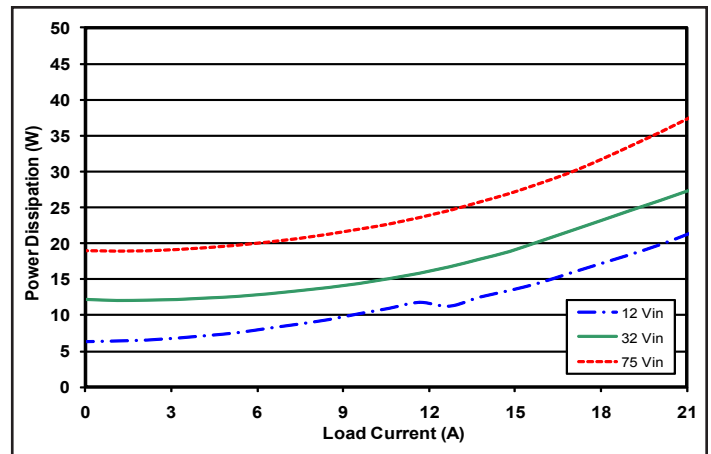

Figure 2: Power Dissipation at nominal output voltage vs. load current for minimum, nominal, and maximum input voltage at 25 °C.

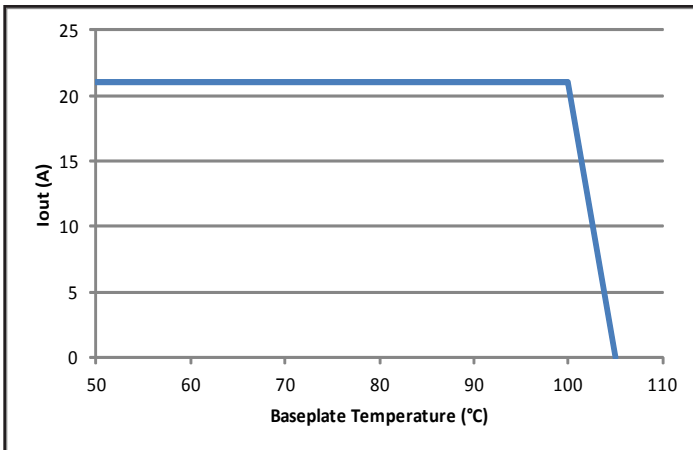

Figure 3: Maximum load current vs. baseplate temperature when conductively cooled. Note: The system design must provide a suitable thermal path that maintains the baseplate temperature below 100 °C.

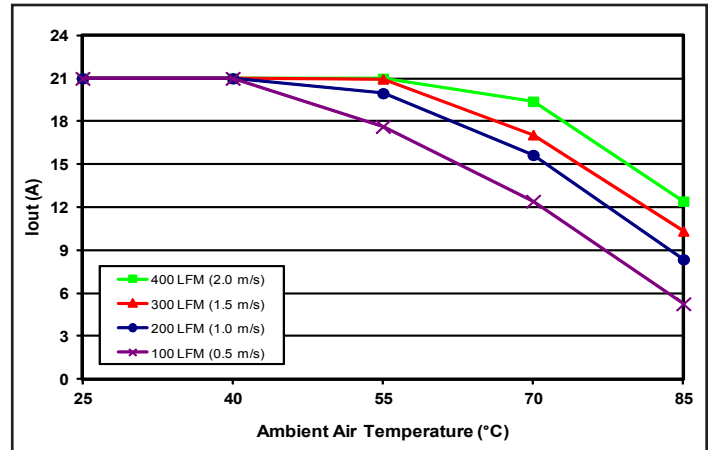

Figure 4: Thermal Derating (max output current vs. ambient air temperature) for encased converter with 1/2" heatsink, at airflow rates of 100 LFM through 400 LFM. Air flows across the converter from input to output (nominal input voltage).

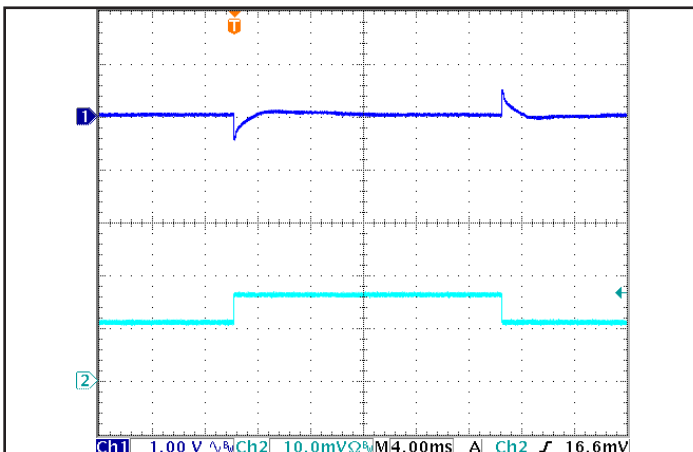

Figure 5: Output Voltage Response to Step-Change in Load Current (50% -75% -50% of Iout(max); dI/dt = 0.1 A/μs). Load cap: 15 μF tantalum cap and 1 μF ceramic cap. Ch 1: Vout (1.00 V/div), Ch 2: Iout (10.0 A/div). Timescale: 4.00 ms/div.

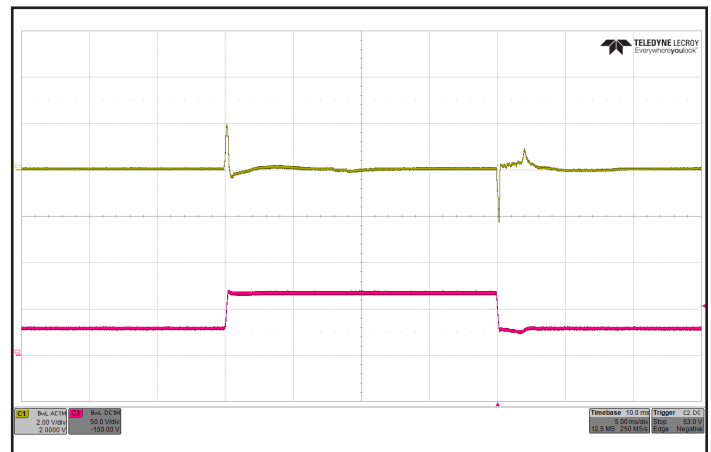

Figure 6: Output Voltage Response to Step-Change in Input Voltage (250 V/ms), at Max. load current. Load cap: 330 μF electrolytic cap and 1 μF ceramic cap. Ch 1: Vout (2.00 V/div), Ch 2: Vin (50.0 V/div). Timescale: 5.00 ms/div.

## IQ32150HZx17 ELECTRICAL CHARACTERISTICS (15.0 Vout)

Ta = 25 °C, airflow rate = 300 LFM, Vin = 32 Vdc unless otherwise noted; full operating temperature range is -40 °C to +100 °C baseplate temperature with appropriate power derating. Specifications subject to change without notice.

Parameter	Min.	Typ.	Max.	Units	Notes & Conditions
<b>INPUT CHARACTERISTICS</b>					
Maximum Input Current			34	A	100 % Load, 9V Vin, trimmed up 10 %
No-Load Input Current (enabled)		450	560	mA	
Disabled Input Current		5	8	mA	
Response to Input Transient		3.6		V	See Figure 6
Input Terminal Ripple Current		1.7		A	RMS
Recommended Input Fuse			50	A	Fast acting fuse recommended; see Note 4
<b>OUTPUT CHARACTERISTICS</b>					
Output Voltage Set Point	14.75	15.00	15.21	V	
Output Voltage Regulation					See Note 3
Over Line		±0.25		%	
Over Load		±0.25		%	
Over Temperature	-375		375	mV	
Total Output Voltage Range	14.55		15.45	V	Over sample, line, load, temperature & life
Output Voltage Ripple and Noise					20 MHz bandwidth; see Note 1
Peak-to-Peak		90	180	mV	Full load
RMS		15	30	mV	Full load
Operating Output Current Range	0		17	A	Subject to thermal derating
Output DC Current Limit Inception	18.4	20.5	22.6	A	Output voltage 10 % Low
Output DC Current Limit Shutdown Voltage		6.0		V	See Note 2
Back-Drive Current Limit while Enabled		5		A	Negative current drawn into output pins
Back-Drive Current Limit while Disabled		3	6	mA	Negative current drawn into output pins
Maximum Output Capacitance			5000	µF	Vout nominal at full load (resistive load)
Output Voltage during Load Current Transient					
Step Change in Output Current (0.1 A/µs)		500		mV	50 % to 75 % to 50 % Iout max; see Figure 5
Settling Time		3		ms	To within 1 % Vout nom; see Figure 5
Output Voltage Trim Range	-50		10	%	Across Pins 8 & 4; Common Figures 3-5
Output Voltage Remote Sense Range			10	%	Across Pins 8 & 4
Output Over-Voltage Protection	17.9	18.7	19.4	V	Over full temp range
<b>EFFICIENCY</b>					
100 % Load		92		%	See Figure 1 for efficiency curve
50 % Load		89		%	See Figure 1 for efficiency curve

Note 1: Output is terminated with 1 µF ceramic and 15 µF low-ESR tantalum capacitors. For applications requiring reduced output voltage ripple and noise, consult SynQor applications support (e-mail: support@synqor.com)

Note 2: If the output voltage falls below the Output DC Current Limit Shutdown Voltage for more than 50 ms, then the unit will enter into hiccup mode, with a 500 ms off-time

Note 3: Line and load regulation is limited by duty cycle quantization and does not indicate a shift in the internal voltage reference

Note 4: Safety certification requires the use of a fuse rated at or below this value.



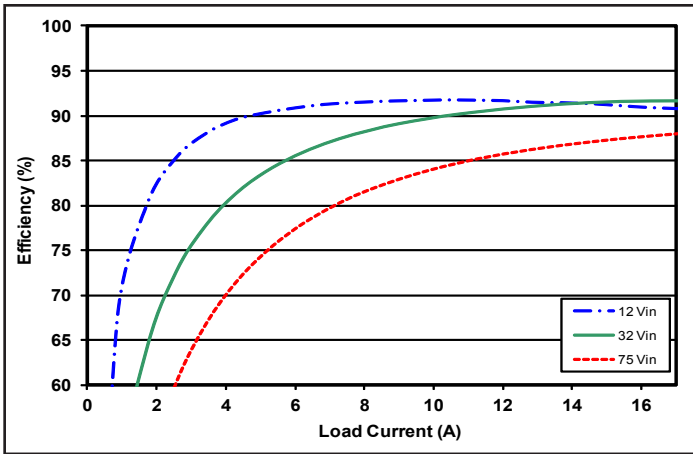

Figure 1: Efficiency at nominal output voltage vs. load current for minimum, nominal, and maximum input voltage at 25 °C.

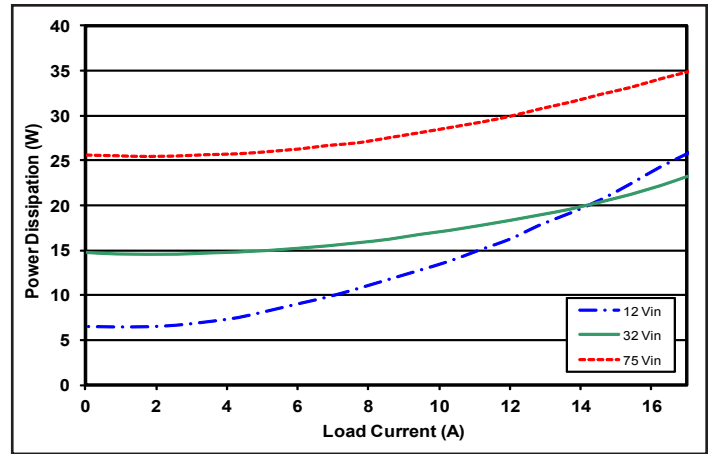

Figure 2: Power Dissipation at nominal output voltage vs. load current for minimum, nominal, and maximum input voltage at 25 °C.

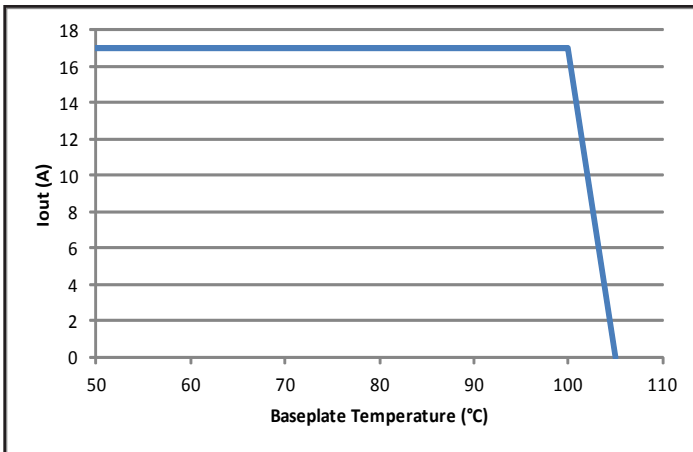

Figure 3: Maximum load current vs. baseplate temperature when conductively cooled. Note: The system design must provide a suitable thermal path that maintains the baseplate temperature below 100 °C.

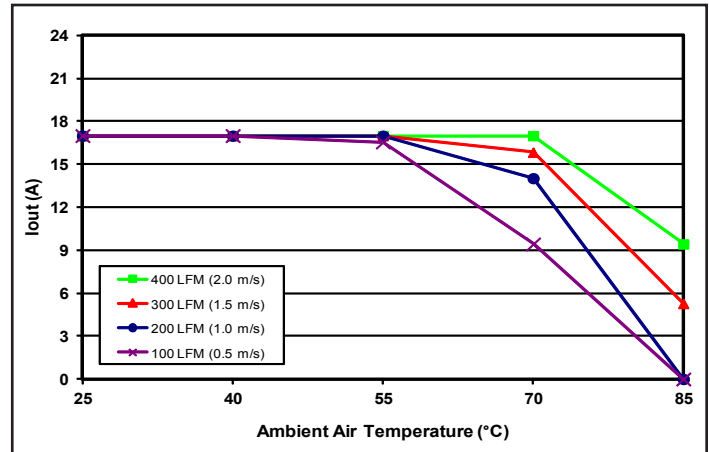

Figure 4: Thermal Derating (max output current vs. ambient air temperature) for encased converter with 1/2" heatsink, at airflow rates of 100 LFM through 400 LFM. Air flows across the converter from input to output (nominal input voltage).

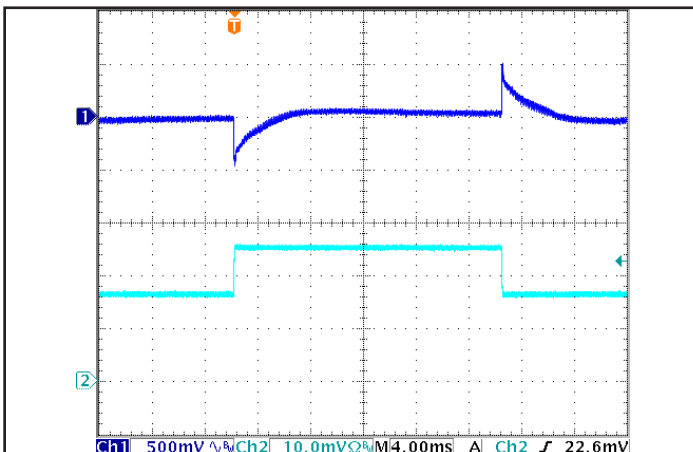

Figure 5: Output Voltage Response to Step-Change in Load Current (50% -75% -50% of Iout(max); dI/dt = 0.1 A/μs). Load cap: 15 μF tantalum cap and 1 μF ceramic cap. Ch 1: Vout (500 mV/div), Ch 2: Iout (5.00 A/div). Timescale: 4.00 ms/div.

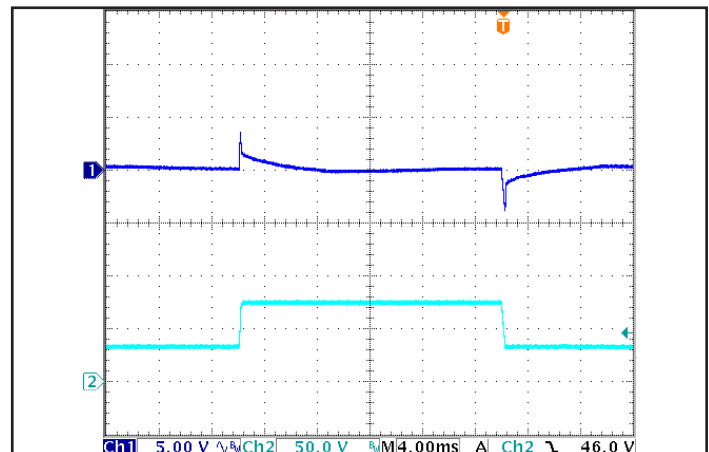

Figure 6: Output Voltage Response to Step-Change in Input Voltage (250 V/ms), at Max. load current. Load cap: 330 μF electrolytic cap and 1 μF ceramic cap. Ch 1: Vout (5.00 V/div), Ch 2: Vin (50.0 V/div). Timescale: 4.00 ms/div.

## IQ32240HZx10 ELECTRICAL CHARACTERISTICS (24.0 Vout)

Ta = 25 °C, airflow rate = 300 LFM, Vin = 32 Vdc unless otherwise noted; full operating temperature range is -40 °C to +100 °C baseplate temperature with appropriate power derating. Specifications subject to change without notice.

Parameter	Min.	Typ.	Max.	Units	Notes & Conditions
<b>INPUT CHARACTERISTICS</b>					
Maximum Input Current			33	A	100 % Load, 9V Vin, trimmed up 10 %
No-Load Input Current (enabled)		370	465	mA	
Disabled Input Current		5	8	mA	
Response to Input Transient		5.6		V	See Figure 6
Input Terminal Ripple Current		1.5		A	RMS
Recommended Input Fuse			50	A	Fast acting fuse recommended; see Note 4
<b>OUTPUT CHARACTERISTICS</b>					
Output Voltage Set Point	23.60	24.00	24.34	V	
Output Voltage Regulation					See Note 3
Over Line		±0.25		%	
Over Load		±0.25		%	
Over Temperature	-600		600	mV	
Total Output Voltage Range	23.28		24.72	V	Over sample, line, load, temperature & life
Output Voltage Ripple and Noise					20 MHz bandwidth; see Note 1
Peak-to-Peak		75	150	mV	Full load
RMS		17	35	mV	Full load
Operating Output Current Range	0		10	A	Subject to thermal derating
Output DC Current Limit Inception	10.8	12.0	13.2	A	Output voltage 10 % Low
Output DC Current Limit Shutdown Voltage		9.6		V	See Note 2
Back-Drive Current Limit while Enabled		5		A	Negative current drawn into output pins
Back-Drive Current Limit while Disabled		3	6	mA	Negative current drawn into output pins
Maximum Output Capacitance			1500	µF	Vout nominal at full load (resistive load)
Output Voltage during Load Current Transient					
Step Change in Output Current (0.1 A/µs)		800		mV	50 % to 75 % to 50 % Iout max; see Figure 5
Settling Time		3.5		ms	To within 1 % Vout nom; see Figure 5
Output Voltage Trim Range	-50		10	%	Across Pins 8 & 4; Common Figures 3-5
Output Voltage Remote Sense Range			10	%	Across Pins 8 & 4
Output Over-Voltage Protection	29.0	30.2	31.4	V	Over full temp range
<b>EFFICIENCY</b>					
100 % Load		91		%	See Figure 1 for efficiency curve
50 % Load		90		%	See Figure 1 for efficiency curve

Note 1: Output is terminated with 1 µF ceramic and 15 µF low-ESR tantalum capacitors. For applications requiring reduced output voltage ripple and noise, consult SynQor applications support (e-mail: support@synqor.com)

Note 2: If the output voltage falls below the Output DC Current Limit Shutdown Voltage for more than 50 ms, then the unit will enter into hiccup mode, with a 500 ms off-time

Note 3: Line and load regulation is limited by duty cycle quantization and does not indicate a shift in the internal voltage reference

Note 4: Safety certification requires the use of a fuse rated at or below this value.

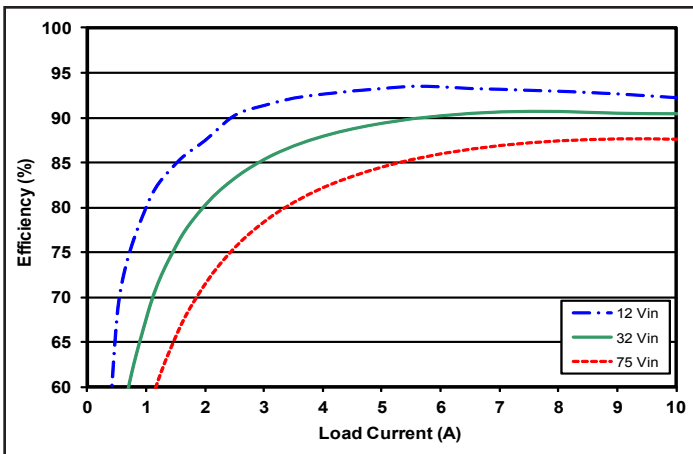

Figure 1: Efficiency at nominal output voltage vs. load current for minimum, nominal, and maximum input voltage at 25 °C.

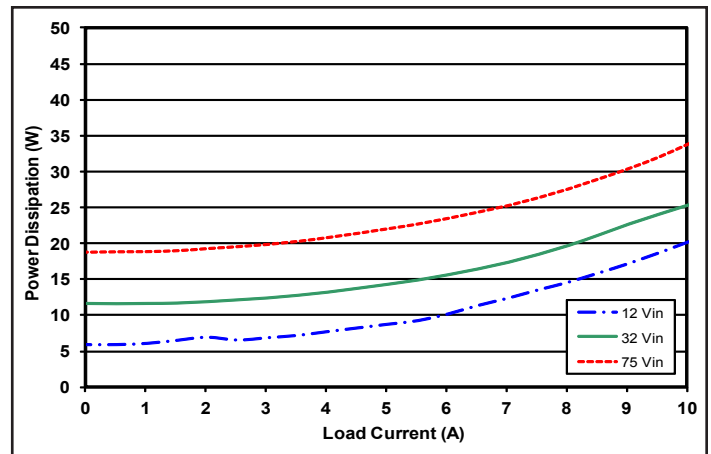

Figure 2: Power Dissipation at nominal output voltage vs. load current for minimum, nominal, and maximum input voltage at 25 °C.

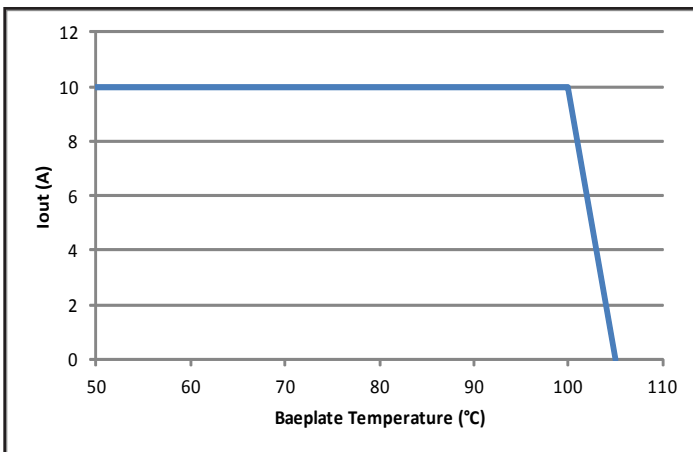

Figure 3: Maximum load current vs. baseplate temperature when conductively cooled. Note: The system design must provide a suitable thermal path that maintains the baseplate temperature below 100 °C.

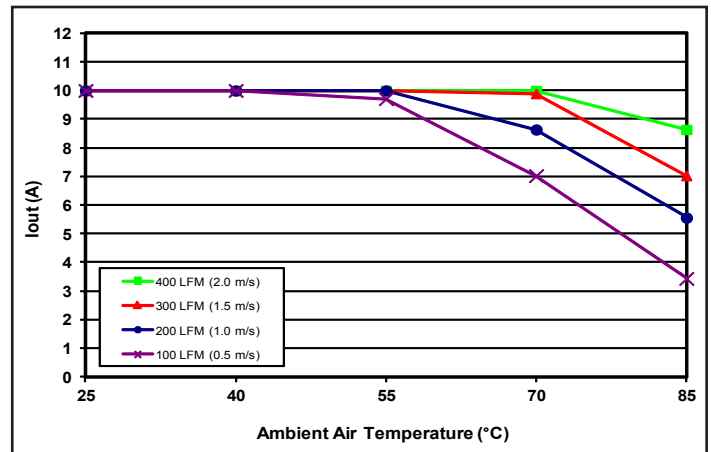

Figure 4: Thermal Derating (max output current vs. ambient air temperature) for encased converter with 1/2" heatsink, at airflow rates of 100 LFM through 400 LFM. Air flows across the converter from input to output (nominal input voltage).

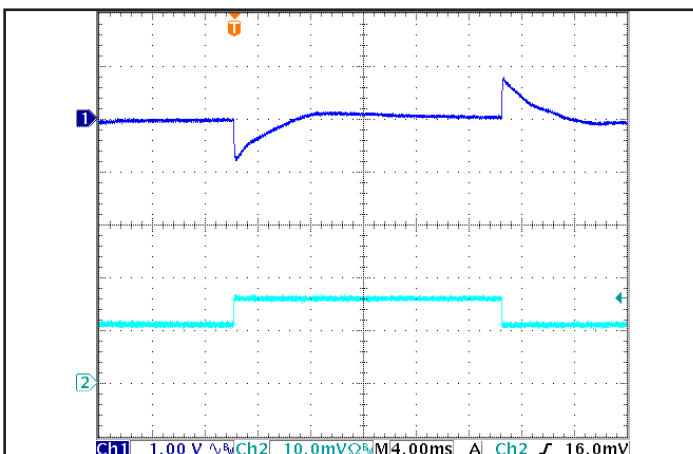

Figure 5: Output Voltage Response to Step-Change in Load Current (50% -75% -50% of Iout(max); dI/dt = 0.1 A/μs). Load cap: 100 μF electrolytic cap and 1 μF ceramic cap. Ch 1: Vout (1.00 V/div), Ch 2: Iout (5.00 A/div). Timescale: 4.00 ms/div.

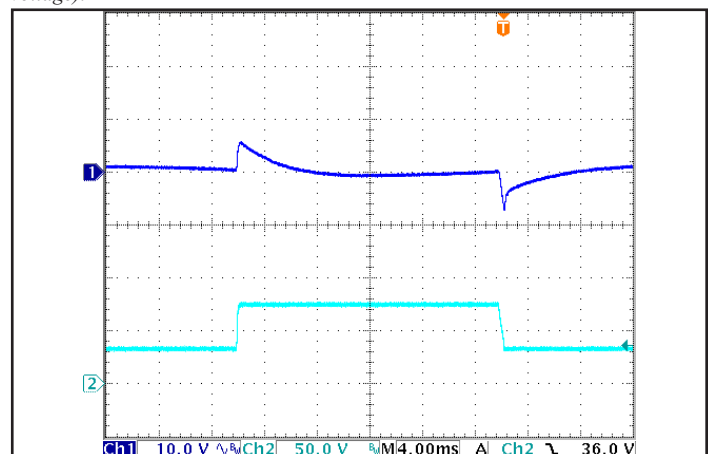

Figure 6: Output Voltage Response to Step-Change in Input Voltage (250 V/ms), at Max. load current. Load cap: 330 μF electrolytic cap and 1 μF ceramic cap. Ch 1: Vout (10.0 V/div), Ch 2: Vin (50.0 V/div). Timescale: 4.00 ms/div.

## IQ32280HZx09 ELECTRICAL CHARACTERISTICS (28.0 Vout)

Ta = 25 °C, airflow rate = 300 LFM, Vin = 32 Vdc unless otherwise noted; full operating temperature range is -40 °C to +100 °C baseplate temperature with appropriate power derating. Specifications subject to change without notice.

Parameter	Min.	Typ.	Max.	Units	Notes & Conditions
<b>INPUT CHARACTERISTICS</b>					
Maximum Input Current			34	A	100 % Load, 9V Vin, trimmed up 10 %
No-Load Input Current (enabled)		425	530	mA	
Disabled Input Current		5	8	mA	
Response to Input Transient		5		V	See Figure 6
Input Terminal Ripple Current		1.5		A	RMS
Recommended Input Fuse			50	A	Fast acting fuse recommended; see Note 4
<b>OUTPUT CHARACTERISTICS</b>					
Output Voltage Set Point	27.54	28.00	28.39	V	
Output Voltage Regulation					See Note 3
Over Line		±0.25		%	
Over Load		±0.25		%	
Over Temperature	-700		700	mV	
Total Output Voltage Range	27.16		28.84	V	Over sample, line, load, temperature & life
Output Voltage Ripple and Noise					20 MHz bandwidth; see Note 1
Peak-to-Peak		150	300	mV	Full load
RMS		30	60	mV	Full load
Operating Output Current Range	0		9	A	Subject to thermal derating
Output DC Current Limit Inception	9.9	11.0	12.1	A	Output voltage 10 % Low
Output DC Current Limit Shutdown Voltage		11		V	See Note 2
Back-Drive Current Limit while Enabled		2.1		A	Negative current drawn into output pins
Back-Drive Current Limit while Disabled		3	6	mA	Negative current drawn into output pins
Maximum Output Capacitance			1000	µF	Vout nominal at full load (resistive load)
Output Voltage during Load Current Transient					
Step Change in Output Current (0.1 A/µs)		950		mV	50 % to 75 % to 50 % Iout max; see Figure 5
Settling Time		2.5		ms	To within 1 % Vout nom; see Figure 5
Output Voltage Trim Range	-50		10	%	Across Pins 8 & 4; Common Figures 3-5
Output Voltage Remote Sense Range			10	%	Across Pins 8 & 4
Output Over-Voltage Protection	33.0	34.4	35.8	V	Over full temp range
<b>EFFICIENCY</b>					
100 % Load		92		%	See Figure 1 for efficiency curve
50 % Load		90		%	See Figure 1 for efficiency curve

Note 1: Output is terminated with 1 µF ceramic and 15 µF low-ESR tantalum capacitors. For applications requiring reduced output voltage ripple and noise, consult SynQor applications support (e-mail: support@synqor.com)

Note 2: If the output voltage falls below the Output DC Current Limit Shutdown Voltage for more than 50 ms, then the unit will enter into hiccup mode, with a 500 ms off-time

Note 3: Line and load regulation is limited by duty cycle quantization and does not indicate a shift in the internal voltage reference

Note 4: Safety certification requires the use of a fuse rated at or below this value.

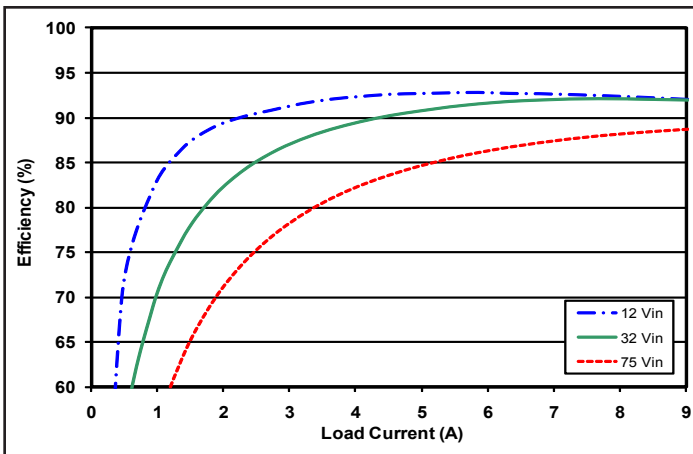

Figure 1: Efficiency at nominal output voltage vs. load current for minimum, nominal, and maximum input voltage at 25 °C.

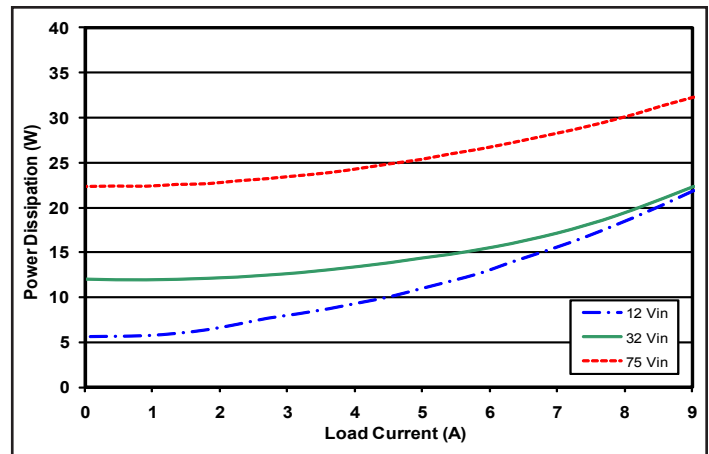

Figure 2: Power Dissipation at nominal output voltage vs. load current for minimum, nominal, and maximum input voltage at 25 °C.

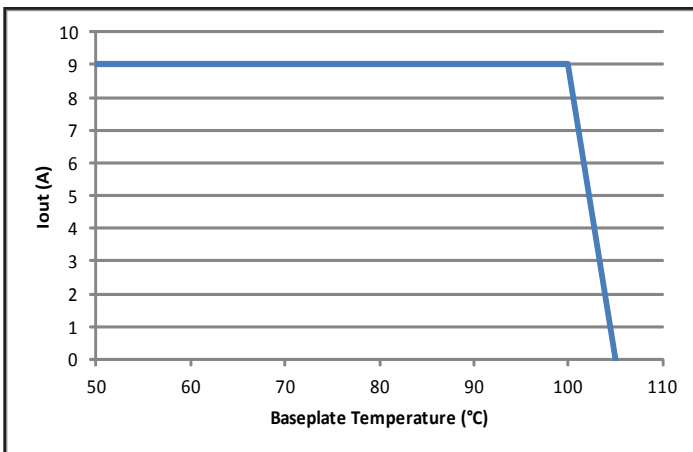

Figure 3: Maximum load current vs. baseplate temperature when conductively cooled. Note: The system design must provide a suitable thermal path that maintains the baseplate temperature below 100 °C.

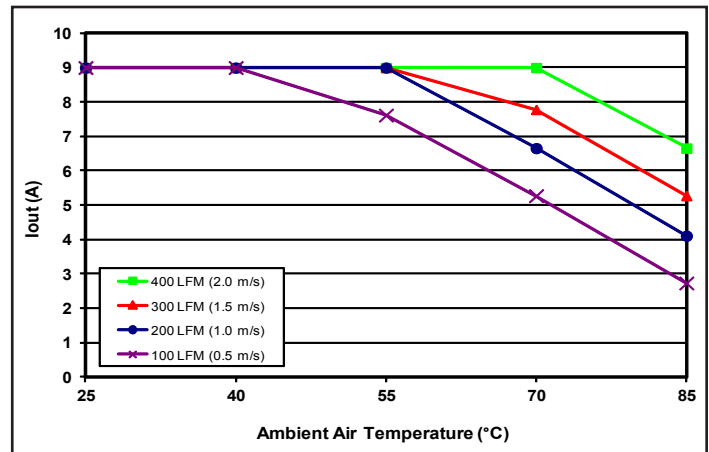

Figure 4: Thermal Derating (max output current vs. ambient air temperature) for encased converter with 1/2" heatsink, at airflow rates of 100 LFM through 400 LFM. Air flows across the converter from input to output (nominal input voltage).

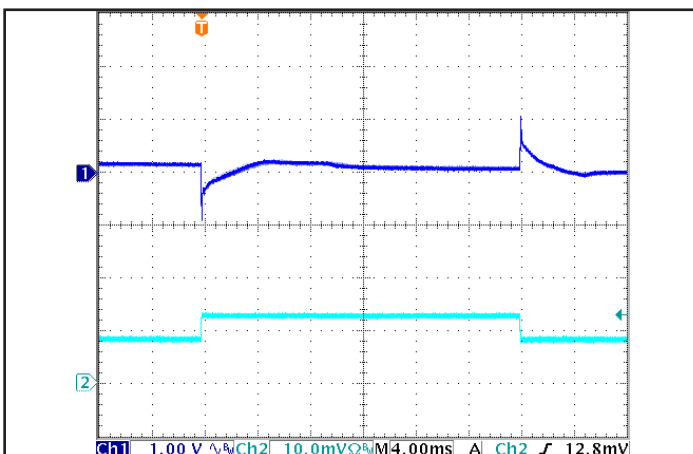

Figure 5: Output Voltage Response to Step-Change in Load Current (50% -75% -50% of I<sub>out</sub>(max); dI/dt = 0.1 A/μs). Load cap: 100 μF electrolytic cap and 1 μF ceramic cap. Ch 1: V<sub>out</sub> (1.00 V/div), Ch 2: I<sub>out</sub> (5.00 A/div). Timescale: 4.00 ms/div.

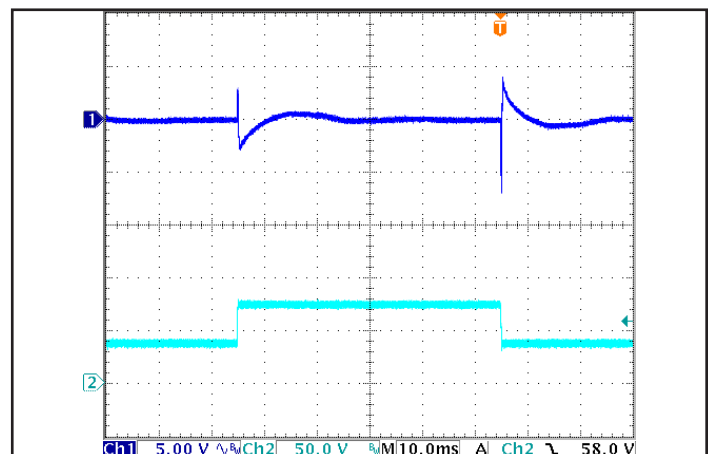

Figure 6: Output Voltage Response to Step-Change in Input Voltage (250 V/ms), at Max. load current. Load cap: 330 μF tantalum cap and 1 μF ceramic cap. Ch 1: V<sub>out</sub> (5.00 V/div), Ch 2: V<sub>in</sub> (50.0 V/div). Timescale: 10.0 ms/div.

## IQ32400HZx06 ELECTRICAL CHARACTERISTICS (40.0 Vout)

Ta = 25 °C, airflow rate = 300 LFM, Vin = 32 Vdc unless otherwise noted; full operating temperature range is -40 °C to +100 °C baseplate temperature with appropriate power derating. Specifications subject to change without notice.

Parameter	Min.	Typ.	Max.	Units	Notes & Conditions
<b>INPUT CHARACTERISTICS</b>					
Maximum Input Current			32	A	100 % Load, 9V Vin, trimmed up 10 %
No-Load Input Current (enabled)		465	550	mA	
Disabled Input Current		5	8	mA	
Response to Input Transient		3		V	See Figure 6
Input Terminal Ripple Current		1.5		A	RMS
Recommended Input Fuse			50	A	Fast acting fuse recommended; see Note 4
<b>OUTPUT CHARACTERISTICS</b>					
Output Voltage Set Point	39.34	40.00	40.56	V	
Output Voltage Regulation					See Note 3
Over Line		±0.25		%	
Over Load		±0.25		%	
Over Temperature	-1000		1000	mV	
Total Output Voltage Range	38.80		41.20	V	Over sample, line, load, temperature & life
Output Voltage Ripple and Noise					20 MHz bandwidth; see Note 1
Peak-to-Peak		100	200	mV	Full load
RMS		20	40	mV	Full load
Operating Output Current Range	0		6	A	Subject to thermal derating
Output DC Current Limit Inception	6.70	7.40	8.10	A	Output voltage 10 % Low
Output DC Current Limit Shutdown Voltage		16		V	See Note 2
Back-Drive Current Limit while Enabled		5		A	Negative current drawn into output pins
Back-Drive Current Limit while Disabled		3	6	mA	Negative current drawn into output pins
Maximum Output Capacitance			470	µF	Vout nominal at full load (resistive load)
Output Voltage during Load Current Transient					
Step Change in Output Current (0.1 A/µs)		900		mV	50 % to 75 % to 50 % Iout max; see Figure 5
Settling Time		2		ms	To within 1 % Vout nom; see Figure 5
Output Voltage Trim Range	-50		10	%	Across Pins 8 & 4; Common Figures 3-5
Output Voltage Remote Sense Range			10	%	Across Pins 8 & 4
Output Over-Voltage Protection	47.2	49.2	51.2	V	Over full temp range
<b>EFFICIENCY</b>					
100 % Load		92		%	See Figure 1 for efficiency curve
50 % Load		90		%	See Figure 1 for efficiency curve

Note 1: Output is terminated with 1 µF ceramic and 15 µF low-ESR tantalum capacitors. For applications requiring reduced output voltage ripple and noise, consult SynQor applications support (e-mail: support@synqor.com)

Note 2: If the output voltage falls below the Output DC Current Limit Shutdown Voltage for more than 50 ms, then the unit will enter into hiccup mode, with a 500 ms off-time

Note 3: Line and load regulation is limited by duty cycle quantization and does not indicate a shift in the internal voltage reference

Note 4: Safety certification requires the use of a fuse rated at or below this value.

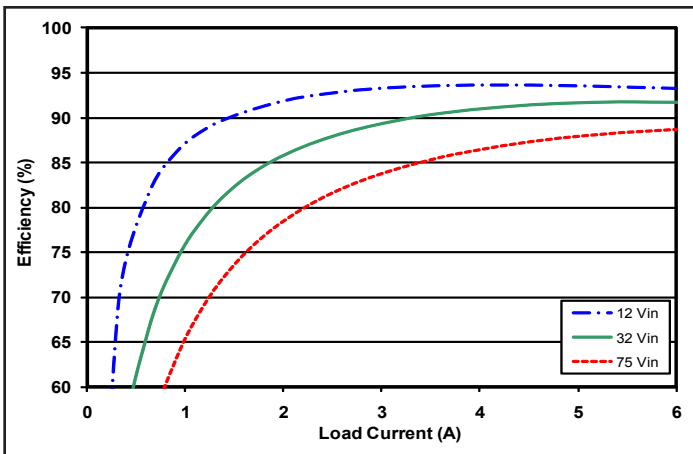

Figure 1: Efficiency at nominal output voltage vs. load current for minimum, nominal, and maximum input voltage at 25 °C.

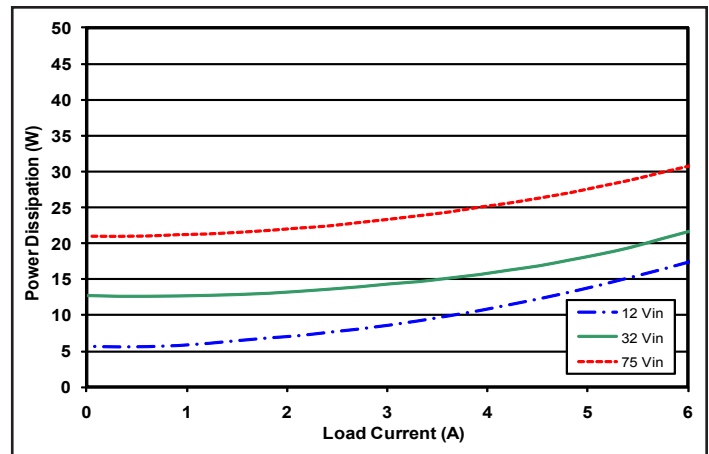

Figure 2: Power Dissipation at nominal output voltage vs. load current for minimum, nominal, and maximum input voltage at 25 °C.

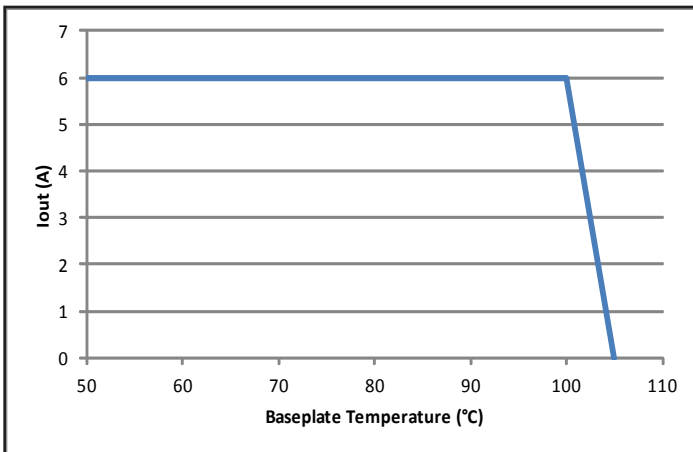

Figure 3: Maximum load current vs. baseplate temperature when conductively cooled. Note: The system design must provide a suitable thermal path that maintains the baseplate temperature below 100 °C.

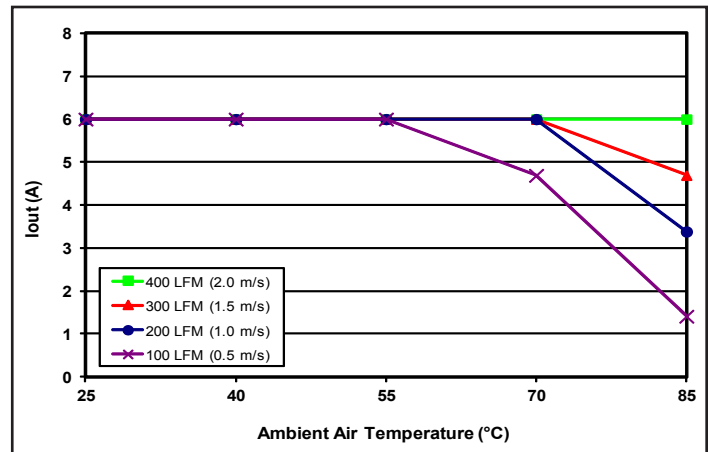

Figure 4: Thermal Derating (max output current vs. ambient air temperature) for encased converter with 1/2" heatsink, at airflow rates of 100 LFM through 400 LFM. Air flows across the converter from input to output (nominal input voltage).

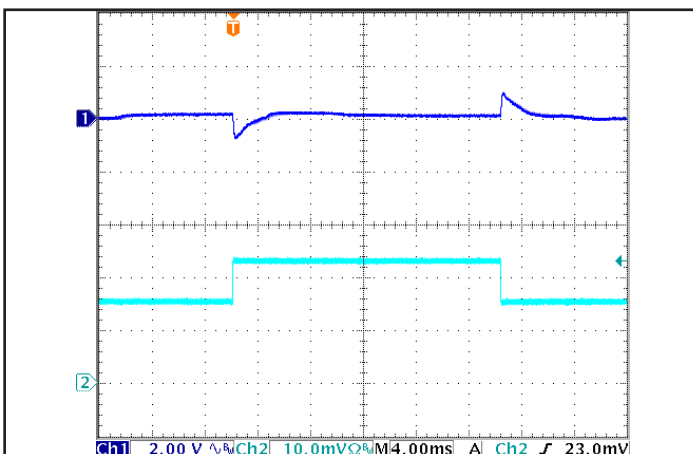

Figure 5: Output Voltage Response to Step-Change in Load Current (50% -75% -50% of Iout(max); dI/dt = 0.1 A/μs). Load cap: 100 μF electrolytic cap and 1 μF ceramic cap. Ch 1: Vout (2.00 V/div), Ch 2: Iout (2.00 A/div). Timescale: 4.00 ms/div.

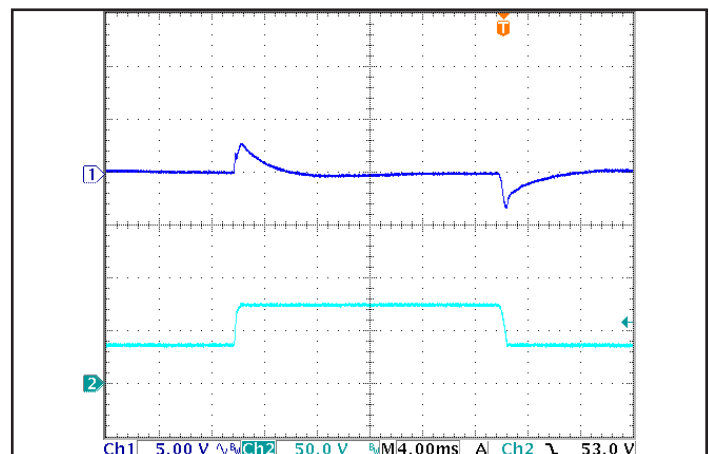

Figure 6: Output Voltage Response to Step-Change in Input Voltage (250 V/ms), at Max. load current. Load cap: 330 μF electrolytic cap and 1 μF ceramic cap. Ch 1: Vout (5.00 V/div), Ch 2: Vin (50.0 V/div). Timescale: 4.00 ms/div.

## IQ32500HZx05 ELECTRICAL CHARACTERISTICS (50.0 Vout)

Ta = 25 °C, airflow rate = 300 LFM, Vin = 32 Vdc unless otherwise noted; full operating temperature range is -40 °C to +100 °C baseplate temperature with appropriate power derating. Specifications subject to change without notice.

Parameter	Min.	Typ.	Max.	Units	Notes & Conditions
<b>INPUT CHARACTERISTICS</b>					
Maximum Input Current			34	A	100 % Load, 9V Vin, trimmed up 10 %
No-Load Input Current (enabled)		400	500	mA	
Disabled Input Current		5	8	mA	
Response to Input Transient		10		V	See Figure 6
Input Terminal Ripple Current		1.6		A	RMS
Recommended Input Fuse			50	A	Fast acting fuse recommended; see Note 4
<b>OUTPUT CHARACTERISTICS</b>					
Output Voltage Set Point	49.18	50.00	50.70	V	
Output Voltage Regulation					See Note 3
Over Line		±0.25		%	
Over Load		±0.25		%	
Over Temperature	-1250		1250	mV	
Total Output Voltage Range	48.50		51.50	V	Over sample, line, load, temperature & life
Output Voltage Ripple and Noise					20 MHz bandwidth; see Note 1
Peak-to-Peak		200	400	mV	Full load
RMS		40	80	mV	Full load
Operating Output Current Range	0		5	A	Subject to thermal derating
Output DC Current Limit Inception	5.40	6.00	6.60	A	Output voltage 10 % Low
Output DC Current Limit Shutdown Voltage		20		V	See Note 2
Back-Drive Current Limit while Enabled		2		A	Negative current drawn into output pins
Back-Drive Current Limit while Disabled		3	6	mA	Negative current drawn into output pins
Maximum Output Capacitance			330	µF	Vout nominal at full load (resistive load)
Output Voltage during Load Current Transient					
Step Change in Output Current (0.1 A/µs)		1800		mV	50 % to 75 % to 50 % Iout max; see Figure 5
Settling Time		1		ms	To within 1 % Vout nom; see Figure 5
Output Voltage Trim Range	-50		10	%	Across Pins 8 & 4; Common Figures 3-5
Output Voltage Remote Sense Range			10	%	Across Pins 8 & 4
Output Over-Voltage Protection	60.1	62.5	65.1	V	Over full temp range
<b>EFFICIENCY</b>					
100 % Load		91		%	See Figure 1 for efficiency curve
50 % Load		90		%	See Figure 1 for efficiency curve

Note 1: Output is terminated with 1 µF ceramic capacitor. For applications requiring reduced output voltage ripple and noise, consult SynQor applications support (e-mail: support@synqor.com)

Note 2: If the output voltage falls below the Output DC Current Limit Shutdown Voltage for more than 50 ms, then the unit will enter into hiccup mode, with a 500 ms off-time

Note 3: Line and load regulation is limited by duty cycle quantization and does not indicate a shift in the internal voltage reference

Note 4: Safety certification requires the use of a fuse rated at or below this value.



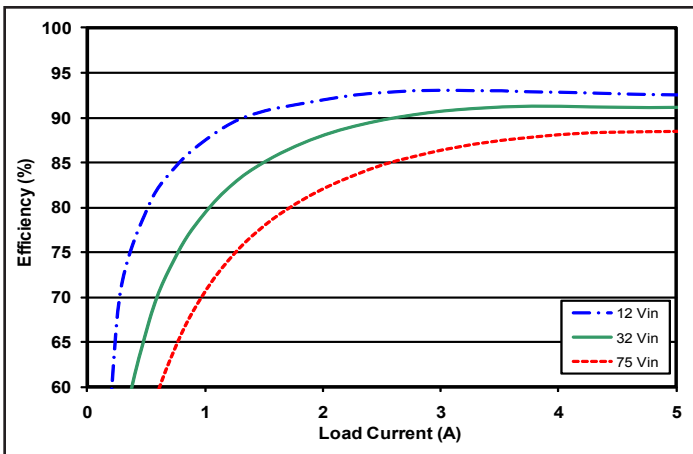

Figure 1: Efficiency at nominal output voltage vs. load current for minimum, nominal, and maximum input voltage at 25 °C.

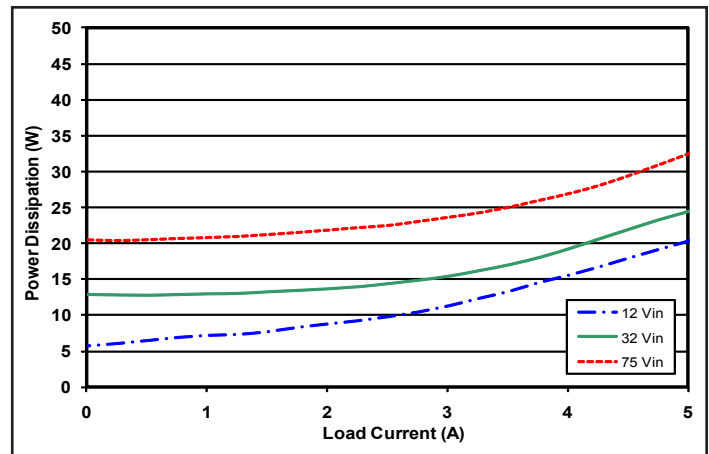

Figure 2: Power Dissipation at nominal output voltage vs. load current for minimum, nominal, and maximum input voltage at 25 °C.

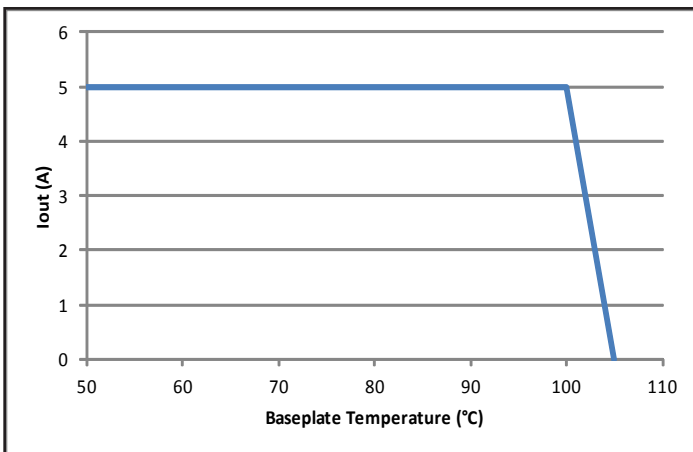

Figure 3: Maximum load current vs. baseplate temperature when conductively cooled. Note: The system design must provide a suitable thermal path that maintains the baseplate temperature below 100 °C.

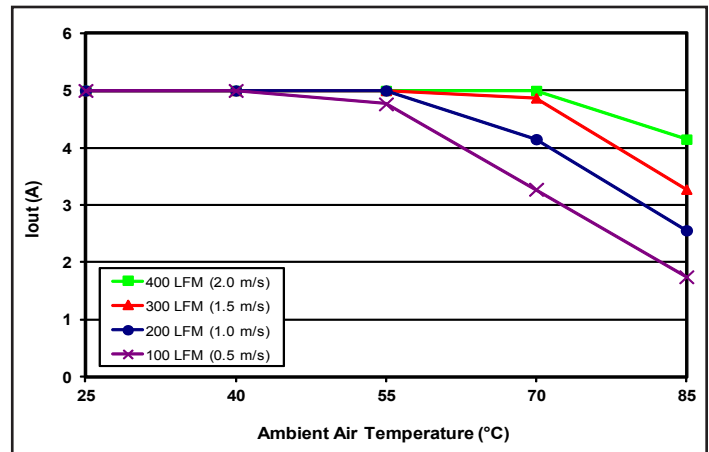

Figure 4: Thermal Derating (max output current vs. ambient air temperature) for encased converter with 1/2" heatsink, at airflow rates of 100 LFM through 400 LFM. Air flows across the converter from input to output (nominal input voltage).

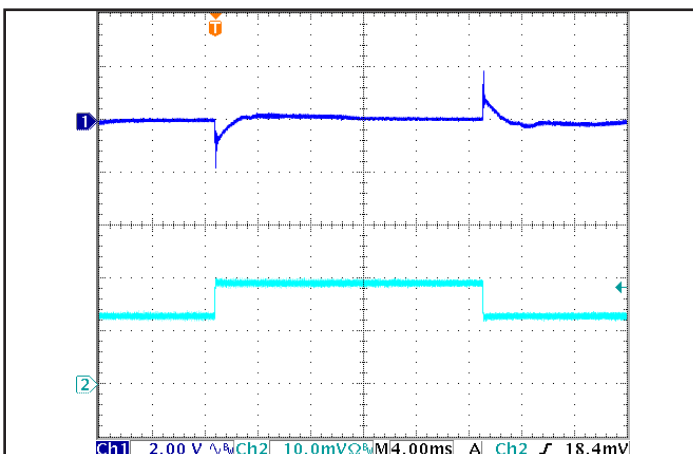

Figure 5: Output Voltage Response to Step-Change in Load Current (50% -75% -50% of Iout(max); dI/dt = 0.1 A/μs). Load cap: 100 μF electrolytic cap and 1 μF ceramic cap. Ch 1: Vout (2.00 V/div), Ch 2: Iout (2.00 A/div). Timescale: 4.00 ms/div.

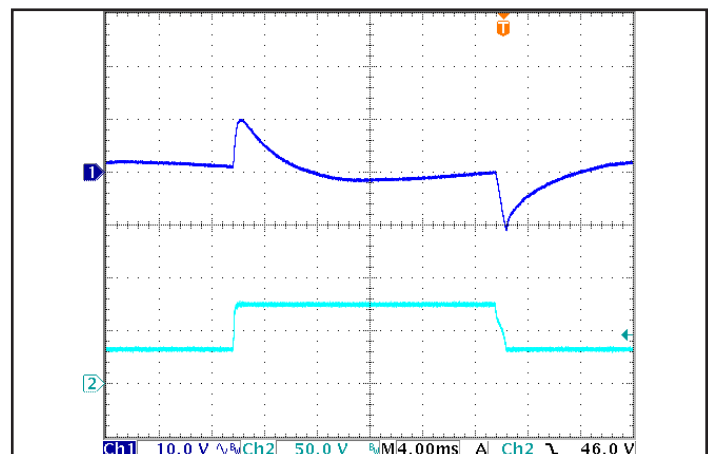

Figure 6: Output Voltage Response to Step-Change in Input Voltage (250 V/ms), at Max. load current. Load cap: 330 μF electrolytic cap and 1 μF ceramic cap. Ch 1: Vout (10.0 V/div), Ch 2: Vin (50.0 V/div). Timescale: 4.00 ms/div.

### BASIC OPERATION AND FEATURES

This converter series uses a two-stage power conversion topology. The first stage keeps the output voltage constant over variations in line, load, and temperature. The second stage uses a transformer to provide the functions of input/output isolation and voltage step-down to achieve the low output voltage required.

Both the first stage and the second stage switch at a fixed frequency for predictable EMI performance. Rectification of the transformer's output is accomplished with synchronous rectifiers. These devices, which are MOSFETs with a very low on-state resistance, dissipate significantly less energy than Schottky diodes, enabling the converter to achieve high efficiency.

Dissipation throughout the converter is so low that it does not require a heatsink or even a baseplate for operation in many applications; however, adding a heatsink provides improved thermal derating performance in extreme situations. To further withstand harsh environments and thermally demanding applications, certain models are available totally encased. See Ordering Information page for available thermal design options.

SynQor half-brick converters use the industry standard footprint and pin-out.

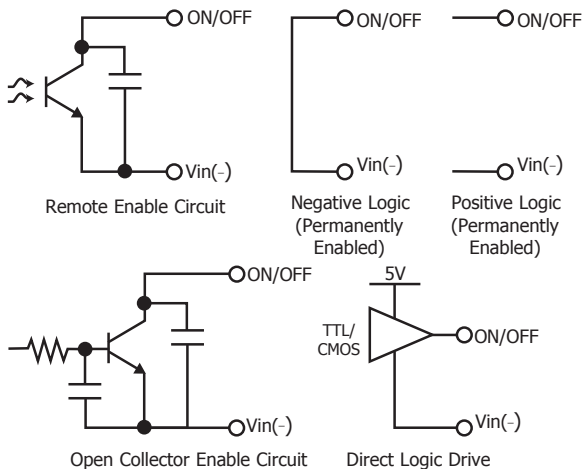

Figure A: Various Circuits for Driving the ON/OFF Pin

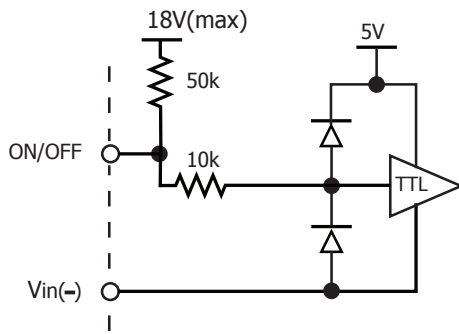

Figure B: Internal ON/OFF Pin Circuitry

### CONTROL FEATURES

**REMOTE ON/OFF (Pin 2):** The ON/OFF input, Pin 2, permits the user to control when the converter is on or off. This input is referenced to the return terminal of the input bus, Vin(-).

In negative logic versions, the ON/OFF signal is active low (meaning that a low voltage turns the converter on). In positive logic versions, the ON/OFF input is active high (meaning that a high voltage turns the converter on). Figure A details possible circuits for driving the ON/OFF pin. Figure B is a detailed look of the internal ON/OFF circuitry. See Ordering Information page for available enable logics.

**REMOTE SENSE Pins 8(+) and 6(-):** The SENSE(+) and SENSE(-) inputs correct for voltage drops along the conductors that connect the converter's output pins to the load.

Pin 8 should be connected to Vout(+) and Pin 6 should be connected to Vout(-) at the point on the board where regulation is desired. If these connections are not made, the converter will deliver an output voltage that is slightly higher than its specified value.

**Note:** The Output Over-Voltage Protection circuit senses the voltage across the output (Pins 9 and 5) to determine when it should trigger, not the voltage across the converters sense leads (Pins 8 and 6). Therefore, the resistive drop on the board should be small enough so that output OVP does not trigger, even during load transients.

**OUTPUT VOLTAGE TRIM (Pin 7):** The TRIM input permits the user to adjust the output voltage across the sense leads up or down according to the trim range specifications. SynQor uses industry standard trim equations.

To decrease the output voltage, the user should connect a resistor between Pin 7 (TRIM) and Pin 6 (SENSE(-) input). For a desired decrease of the nominal output voltage, the value of the resistor should be:

$$R_{\text{trim-down}} = \left( \frac{100\%}{\Delta\%} - 2 \right) \text{ k}\Omega$$

where

$$\Delta\% = \left| \frac{V_{\text{nominal}} - V_{\text{desired}}}{V_{\text{nominal}}} \right| \times 100\%$$

To increase the output voltage, the user should connect a resistor between Pin 7 (TRIM) and Pin 8 (SENSE(+) input). For a desired increase of the nominal output voltage, the value of the resistor should be:

$$R_{\text{trim-up}} = \frac{\left( \frac{V_{\text{nominal}}}{1.225} - 2 \right) \times V_{\text{desired}} + V_{\text{nominal}}}{V_{\text{desired}} - V_{\text{nominal}}} \text{ k}\Omega$$

The Trim Graph in Technical Features shows the relationship between the trim resistor value and Rtrim-up and Rtrim-down, showing the total range the output voltage can be trimmed up or down.

**Note:** The TRIM feature does not affect the voltage at which the output over-voltage protection circuit is triggered. Trimming the output voltage too high may cause the over-voltage protection circuit to engage, particularly during transients.

It is not necessary for the user to add capacitance at the TRIM pin. The node is internally filtered to eliminate noise.

**Total DC Variation of Vout:** For the converter to meet its full specifications, the maximum variation of the DC value of Vout, due to both trimming and remote load voltage drops, should not be greater than that specified for the output voltage trim range.

**Active Trimming:** Active trimming of the output voltage is supported, but dynamic active trimming with feedback is discouraged due to the potential for limit-cycling. If such trimming is necessary, control loop bandwidth should be limited to <1 Hz. A deadband which is at least as large as the line/load regulation specification is also recommended, but not required.

## Protection Features

**Input Under-Voltage Lockout (UVLO):** The converter is designed to turn off when the input voltage is too low, helping to avoid an input system instability problem, which is described in more detail in the application note titled "Input System Instability" on the SynQor website. The lockout circuitry is a comparator with DC hysteresis. When the input voltage is rising, it must exceed the typical "Turn-On Voltage Threshold" value\* before the converter will turn on. Once the converter is on, the input voltage must fall below the typical Turn-Off Voltage Threshold value before the converter will turn off.

**Output Current Limit (OCP):** If the output current exceeds the "Output DC Current Limit Inception" value\*, then a fast linear current limit controller will reduce the output voltage to maintain a constant output current. If as a result, the output voltage falls below the "Output DC Current Limit Shutdown Voltage"\* for more than 50 ms\*\*, then the unit will enter into hiccup mode, with a 500 ms off-time. The unit will then automatically attempt to restart.

**Back-Drive Current Limit:** If there is negative output current of a magnitude larger than the "Back-Drive Current Limit while Enabled" specification\*, then a fast back-drive limit controller will increase the output voltage to maintain a constant output current. If this results in the output voltage exceeding the "Output Over-Voltage Protection" threshold\*, then the unit will shut down.

**Output Over-Voltage Limit (OVP):** If the voltage across the output pins exceeds the Output Over-Voltage Protection threshold, the converter will immediately stop switching. This prevents damage to the load circuit due to 1) excessive series resistance in output current path from converter output pins to sense point, 2) a release of a short-circuit condition, or 3) a release of a current limit condition. Load capacitance determines exactly how high the output voltage will rise in response to these conditions. After 500ms the converter will automatically restart for all but the S Feature Set option, which is latching and will not restart until input power is cycled or the ON/OFF input is toggled.

**Over-Temperature Shutdown (OTP):** A temperature sensor on the converter senses the average temperature of the module. The thermal shutdown circuit is designed to turn the converter off when the temperature at the sensed location reaches the "Over-Temperature Shutdown" value\*. It will allow the converter to turn on again when the temperature of the sensed location falls by the amount of the "Over-Temperature Shutdown Restart Hysteresis" value\*.

**Startup Inhibit Period:** The Startup Inhibit Period ensures that the converter will remain off for approximately 500 ms when it is shut down due to a fault. This generates a 2 Hz "hiccup mode," which prevents the converter from overheating. In all, there are three ways that the converter can be shut down, initiating a Startup Inhibit Period:

- Output Over-Voltage Protection
- Current Limit
- Short Circuit Protection

\* See Electrical Characteristics section.

\*\* Certain models may have an extended on-time, longer than 50 ms.

### APPLICATION CONSIDERATIONS

**Input System Instability:** This condition can occur because any DC-DC converter appears incrementally as a negative resistance load. A detailed application note titled "Input System Instability" is available on the SynQor website which provides an understanding of why this instability arises, and shows the preferred solution for correcting it.

**Application Circuits:** A typical circuit diagram, Figure C below details the input filtering and voltage trimming.

**Input Filtering and External Input Capacitance:** Figure D below shows the internal input filter components. This filter dramatically reduces input terminal ripple current, which otherwise could exceed the rating of an external electrolytic input capacitor. The recommended external input capacitance is specified in the Input Characteristics section of the Electrical Specifications. More detailed information is available in the application note titled "EMI Characteristics" on the SynQor website.

**Output Filtering and External Output Capacitance:** The internal output filter components are shown in Figure D below. This filter dramatically reduces output voltage ripple. Some minimum external output capacitance is required, as specified in the Output Characteristics area of the Electrical Characteristics section. No damage will occur without this capacitor connected, but peak output voltage ripple will be much higher.

**Thermal Considerations:** For baseplated and encased versions, the max operating baseplate temperature,  $T_B$ , is 100°C. Refer to the Thermal Derating Curves in the Technical Figures section to see the available output current at baseplate temperatures below 100°C.

A power derating curve can be calculated for any heatsink that is attached to the base-plate of the converter. It is only necessary to determine the thermal resistance,  $R_{THBA}$ , of the chosen heatsink between the baseplate and the ambient air for a given airflow rate. This information is usually available from the heatsink vendor. The following formula can be used to determine the maximum power the converter can dissipate for a given thermal condition if its base-plate is to be no higher than 100°C.

$$P_{diss}^{max} = \frac{100^{\circ}C - T_A}{R_{THBA}}$$

This value of maximum power dissipation can then be used in conjunction with the data shown in the Power Dissipation Curves in the Technical Figures section to determine the maximum load current (and power) that the converter can deliver in the given thermal condition.

For convenience, Thermal Derating Curves are provided in the Technical Figures section.

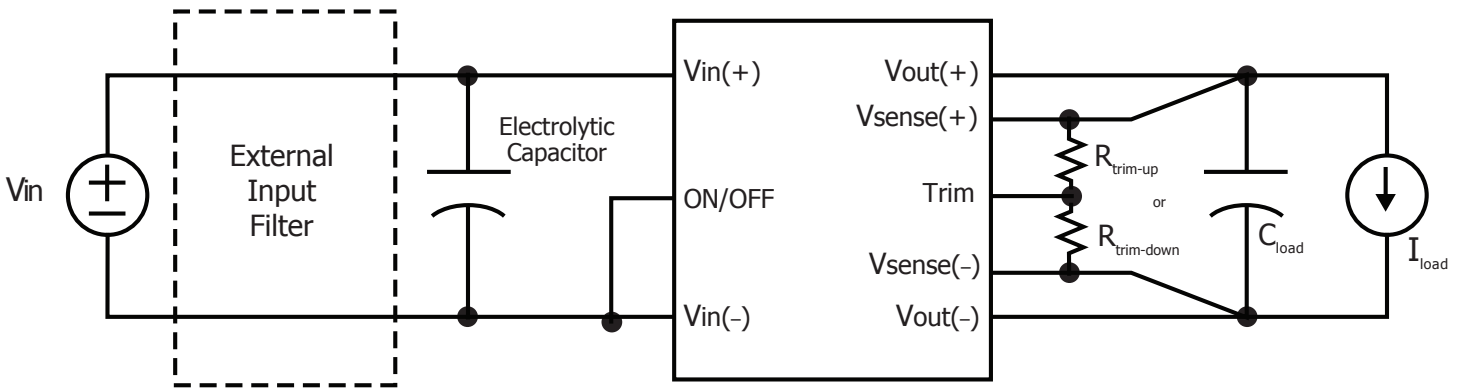

Figure C: Typical Application Circuit (negative logic unit, permanently enabled)

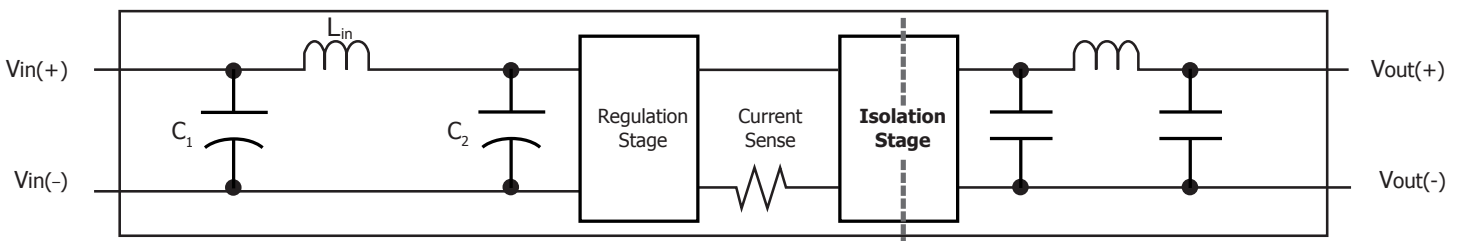

Figure D: Internal Input and Output Filter Diagram (component values listed in Electrical Characteristics section)

### ACTIVE CURRENT SHARE

**Overview:** The full-featured option, specified by an "F" in the last character in the part number, has current sharing operation supported, achieved by adding two additional pins: SHARE(+) and SHARE(-).

**Connection of Paralleled Units:** Up to 100 units can be placed in parallel. In this current share architecture, one unit is dynamically chosen to act as a master, controlling all other units. It cannot be predicted which unit will become the master at any given time, so units should be wired symmetrically (see Figures E & F).

- Input power pins and output power pins should be tied together between units, preferably with wide overlapping copper planes, after any input common-mode choke.
- The SHARE(+) and SHARE(-) pins should be routed between all paralleled units as a differential pair.
- The ON/OFF pins should be connected in parallel, and rise/fall times should be kept below 2 ms.
- The SENSE(+) and SENSE(-) pins should be connected either locally at each unit or separately to a common sense point. If an output common-mode choke is used, sense lines should be connected on the module-side of the choke.
- If the TRIM pin is used, then each unit should have its own trim resistor connected locally between TRIM and SENSE(+) or SENSE(-).

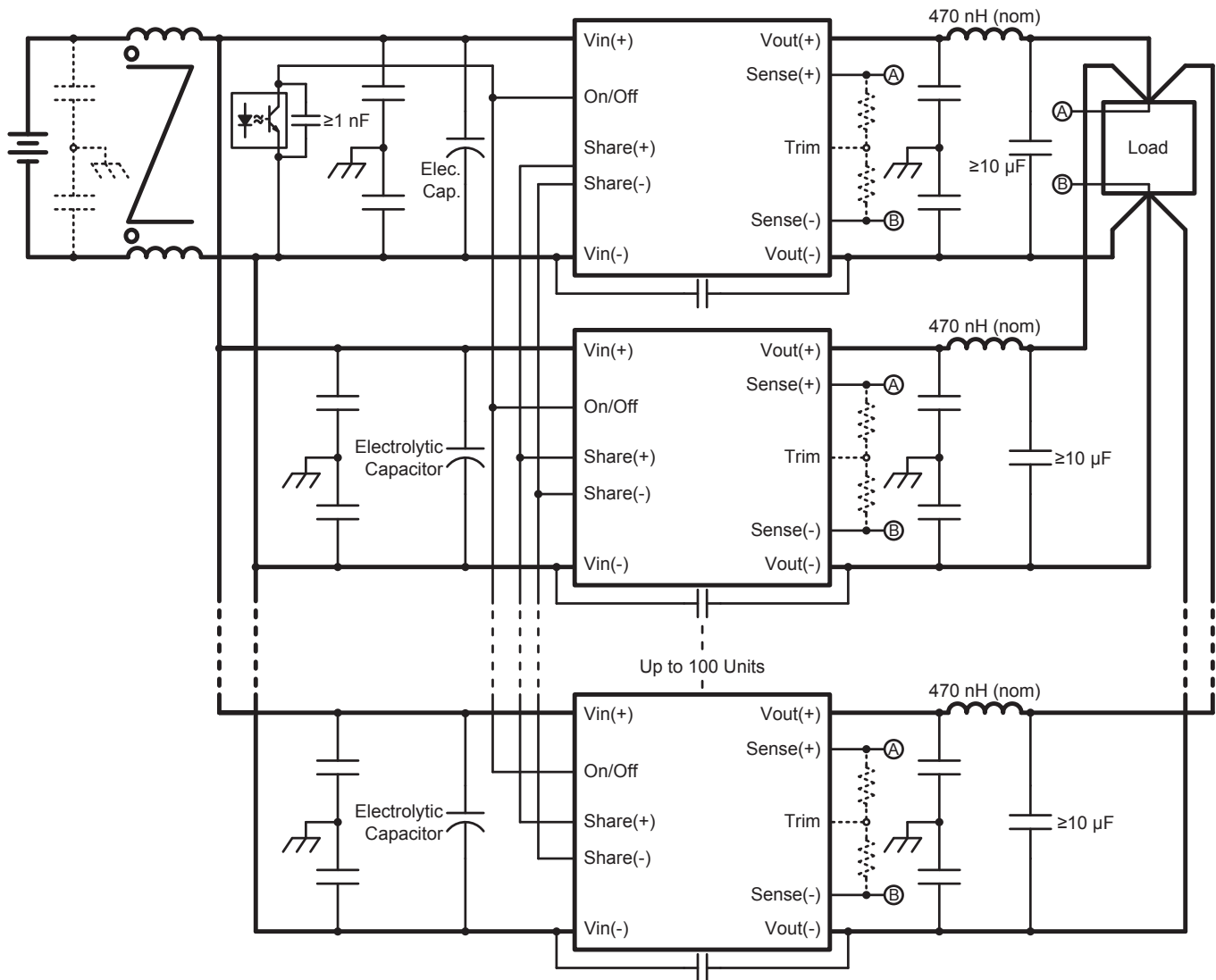

**Figure E: Typical Application Circuit for Paralleling of Full-Featured Units with an Input Common-Mode Choke.** If an input common-mode choke is used, Vin(-) MUST be tied together AFTER the choke for all units. 470 nH (nominal) inductor or an output common-mode choke is required for outputs >18 V. See Figure F for output common-mode choke configuration.

**Automatic Configuration:** The micro-controller inside each power converter unit is programmed at the factory with a unique chip number. In every other respect, each shared unit is identical and has the same orderable part number.

On initial startup (or after the master is disabled or shuts down), each unit determines the chip number of every other unit currently connected to the shared serial bus formed by the SHARE(+) and SHARE(-) pins. The unit with the highest chip number dynamically reconfigures itself from slave to master. The rest of the units (that do not have the highest chip number) become slaves.

The master unit then broadcasts its control state over the shared serial bus on a cycle-by-cycle basis. The slave units interpret and implement the control commands sent by the master, mirroring every action of the master unit.

If the master is disabled or encounters a fault condition, all units will immediately shut down, and if the master unit is unable to restart, then the unit with the next highest chip number will become master. If a slave unit is disabled or encounters a fault condition, all other units continue to run, and the slave unit can restart seamlessly.

**Automatic Interleaving:** The slave units automatically lock frequency with the master, and interleave the phase of their switching transitions for improved EMI performance. To obtain the phase angle relative to the master, each slave divides 360 degrees by the total number of connected units, and multiplies the result by its rank among chip numbers of connected units.

**ORing Diodes** placed in series with the converter outputs must also have a resistor smaller than 500  $\Omega$  placed in parallel. This resistor keeps the output voltage of a temporarily disabled slave unit consistent with the active master unit. If the output voltage of the slave unit were allowed to totally discharge, and the slave unit tried to restart, it would fail because the slave reproduces the duty cycle of the master unit, which is running in steady state and cannot repeat an output voltage soft-start.

**Common-Mode Filtering** may be done as one of the following:

- Single primary-side choke handling inputs of all paralleled units.
- Multiple primary-side chokes placed at the input of each unit.
- Single secondary-side choke handling outputs of all paralleled units.
- Multiple secondary-side chokes placed at the output of each unit.
  - Adding a choke at the output of each unit eliminates the need for an inductor at the output of shared units when  $V_{out} > 18$  V.
  - If an output choke is used, SENSE connections must be made on the module-side of the choke.

**Resonance Between Output Capacitors is Possible:** When multiple higher-voltage modules are paralleled, it is possible to excite a series resonance between the output capacitors internal to the module and the parasitic inductance of the module output pins. This is especially likely at higher output voltages where the module internal capacitance is relatively small. This problem is independent of external output capacitance. For modules with an output voltage greater than 18 V, to ensure that this resonant frequency is below the switching frequency it is recommended to add a nominal 470 nH of inductance, located close to the module, in series with each converter output. There must be at least 10  $\mu$ F of capacitance per converter, located on the load-side of that inductor. The inductance could be from the leakage inductance of a secondary-side common-mode choke; in which case the output capacitor should be appropriately sized for the chosen choke. When using an output common-mode choke, the Sense lines must be connected on the module-side of the common-mode choke (see Figure F).

**RS-485 Physical Layer:** The internal RS-485 transceiver includes many advanced protection features for enhanced reliability:

- Current Limiting and Thermal Shutdown for Driver Overload Protection
- IEC61000 ESD Protection to +/- 16.5 kV
- Hot Plug Circuitry – SHARE(+) and SHARE(-) Outputs Remain Tri-State During Power-up/Power-down

**Internal Schottky Diode Termination:** Despite signaling at high speed with fast edges, external termination resistors are not necessary. Each receiver has four Schottky diodes built in, two for each line in the differential pair. These diodes clamp any ringing caused by transmission line reflections, preventing the voltage from going above about 5.5 V or below about -0.5 V. Any subsequent ringing then inherently takes place between 4.5 and 5.5 V or between -0.5 and 0.5 V. Since each receiver on the bus contains a set of clamping diodes to clamp any possible transmission line reflection, the bus does not necessarily need to be routed as a daisy-chain.

Pins SHARE(+) and SHARE(-) are referenced to  $V_{in}(-)$ , and therefore should be routed as a differential pair near the  $V_{in}(-)$  plane for optimal signal integrity. The maximum difference in voltage between  $V_{in}(-)$  pins of all units on the share-bus should be kept within 0.3 V to prevent steady-state conduction of the termination diodes. Therefore, the  $V_{in}(-)$  connections to each unit must be common, preferably connected by a single copper plane.

**Share Accuracy:** Inside each converter micro-controller, the duty cycle is generated digitally, making for excellent duty cycle matching between connected units. Some small duty cycle mismatch is caused by (well controlled) process variations in the MOSFET gate drivers. However, the voltage difference induced by this duty cycle mismatch appears across the impedance of the entire power converter, from input to output, multiplied by two, since the differential current flows out of one converter and into another. So, a small duty cycle mismatch yields very small differential currents, which remain small even when 100 units are placed in parallel.

In other current-sharing schemes, it is common to have a current-sharing control loop in each unit. However, due to the limited bandwidth of this loop, units do not necessarily share current on startup or during transients before this loop has a chance to respond. In contrast, the current-sharing scheme used in this product has no control dynamics: control signals are transmitted fast enough that the slave units can mirror the control state of the master unit on a cycle-by-cycle basis, and the current simply shares properly, from the first switching cycle to the last.

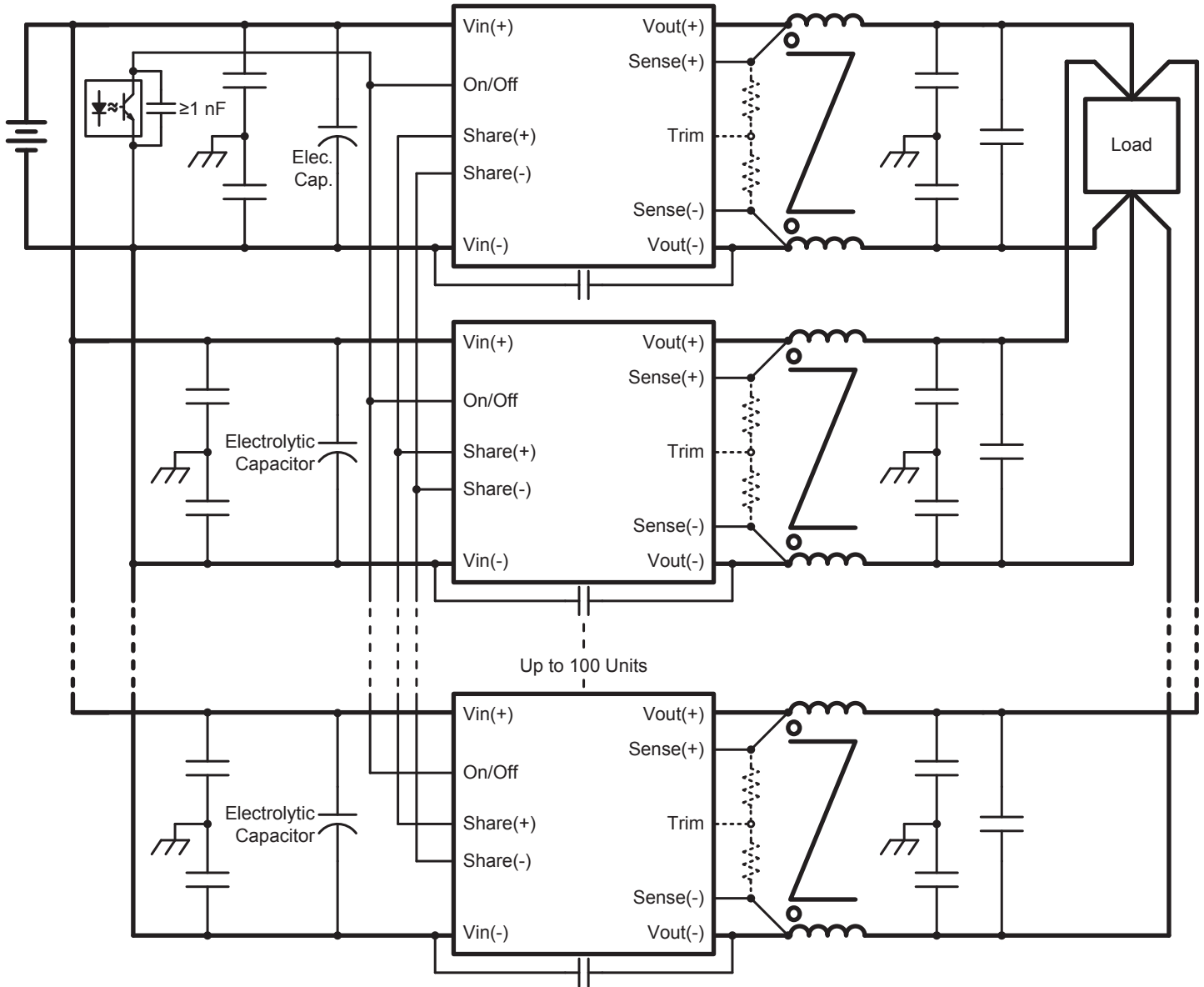

*Figure F: Typical Application Circuit for Paralleling of Full-Featured Units with an Output Common-Mode Choke. When using an output common-mode choke, SENSE lines must be connected on the module-side of the choke. See Figure E for configuration with an input common-mode choke.*

### Standards & Qualification Testing

Parameter	Notes & Conditions
<b>STANDARDS COMPLIANCE</b>	
UL 60950-1	Basic Insulation
CAN/CSA-C22.2 No. 60950-1	
EN 60950-1	

Note: An external input fuse must always be used to meet these safety requirements. Contact SynQor for official safety certificates on new releases or download from the SynQor website.

Parameter	# Units	Test Conditions
<b>QUALIFICATION TESTING</b>		
Life Test	32	95% rated Vin and load, units at derating point, 1000 hours
Vibration	5	10-55 Hz sweep, 0.060 " total excursion, 1 min./sweep, 120 sweeps for 3 axis
Mechanical Shock	5	100 g minimum, 2 drops in x, y, and z axis
Temperature Cycling	10	-40 °C to 100 °C, unit temp. ramp 15 °C/min., 500 cycles
Power/Thermal Cycling	5	Toperating = min to max, Vin = min to max, full load, 100 cycles
Design Marginality	5	Tmin-10 °C to Tmax+10 °C, 5 °C steps, Vin = min to max, 0-105% load
Humidity	5	85 °C, 95% RH, 1000 hours, continuous Vin applied except 5 min/day
Solderability	15 pins	MIL-STD-883, method 2003
Altitude	2	70,000 feet (21 km), see Note

Note: A conductive cooling design is generally needed for high altitude applications because of naturally poor convective cooling at rare atmospheres.



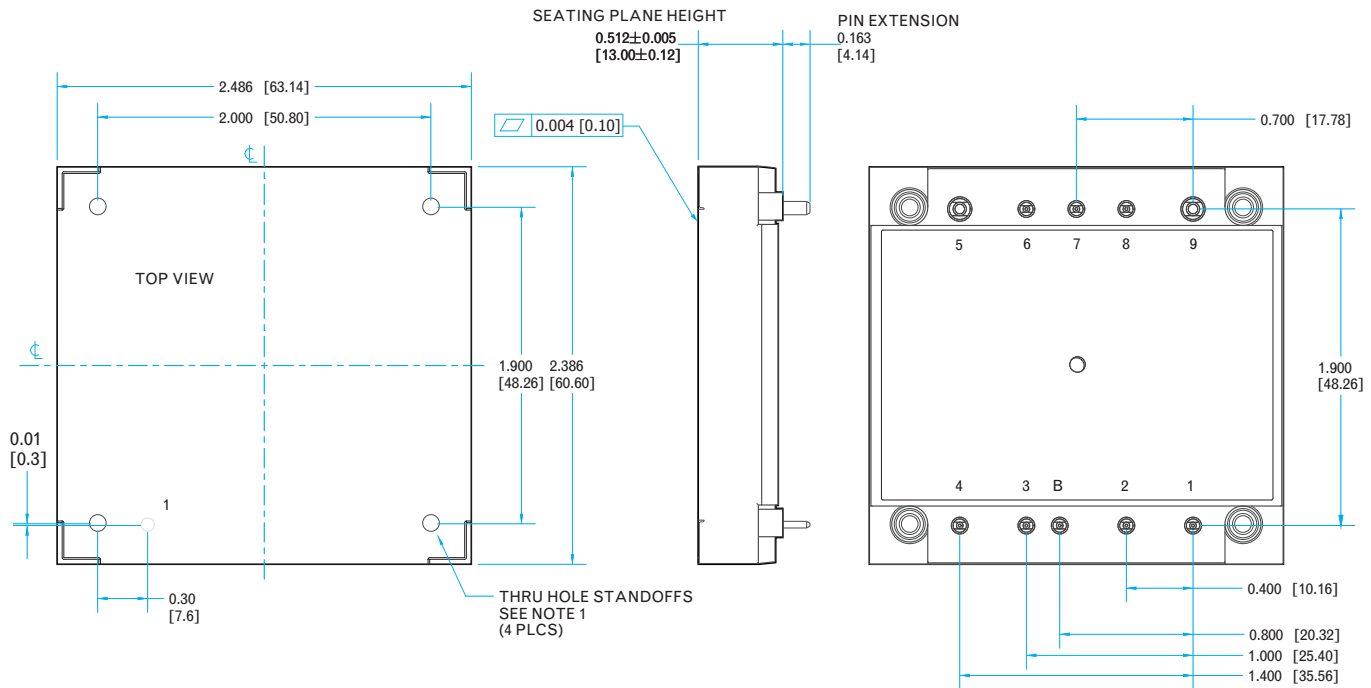

### NOTES

- Applied torque per M3 screw should not exceed 6in-lb. (0.7 Nm).
- Baseplate flatness tolerance is 0.004" (.10 mm) TIR for surface.
- Pins 1-4, 6-8, and B are 0.040" (1.02mm) diameter, with 0.080" (2.03mm) diameter standoff shoulders.
- Pins 5 and 9 are 0.080" (2.03 mm) diameter with 0.125" (3.18 mm) diameter standoff shoulders.
- All Pins: Material - Copper Alloy; Finish - Matte Tin over Nickel plate
- Undimensioned components are shown for visual reference only.
- Weight: 4.9 oz (138 g)
- All dimensions in inches (mm).  
Tolerances:  
x.xx +/-0.02 in. (x.x +/-0.5mm)  
x.xxx +/-0.010 in. (x.xx +/-0.25mm)  
unless otherwise noted.
- Workmanship: Meets or exceeds IPC-A-610C Class II

### PIN DESIGNATIONS

Pin	Name	Function
1	Vin(+)	Positive input voltage
2	ON/OFF	TTL input to turn converter on and off, referenced to Vin(-), with internal pull up.
B	SHARE(+)	Active current share differential pair (See note 4)
3	SHARE(-)	
4	Vin(-)	Negative input voltage
5	Vout(-)	Negative output voltage
6	SENSE(-)	Negative remote sense (See note 1)
7	TRIM	Output voltage trim (See note 2)
8	SENSE(+)	Positive remote sense (See note 3)
9	Vout(+)	Positive output voltage

#### Notes:

- SENSE(-) should be connected to Vout(-) either remotely or at the converter.
- Leave TRIM pin open for nominal output voltage.
- SENSE(+) should be connected to Vout(+) either remotely or at the converter.
- Full-Featured option only. Pin 3 and Pin B not populated on standard model.

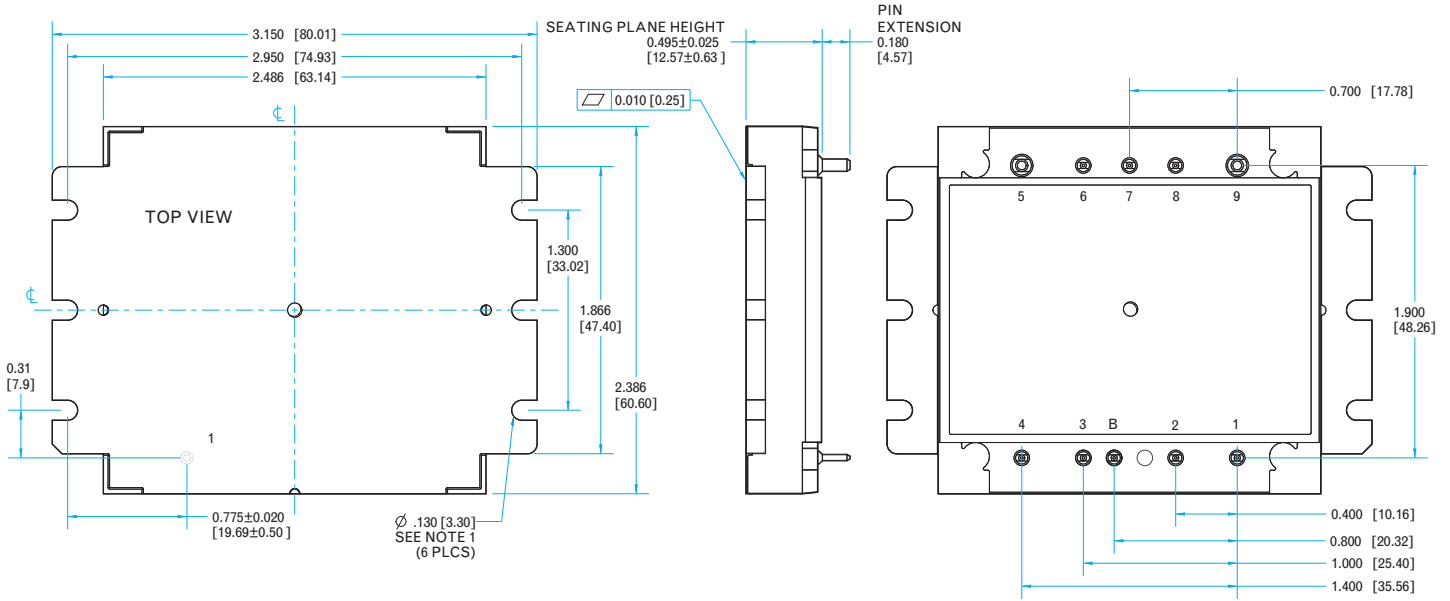

### NOTES

- Applied torque per M3 or 4-40 screw should not exceed 6in-lb. (0.7 Nm).
- Baseplate flatness tolerance is 0.01" (.25 mm) TIR for surface.
- Pins 1-4, 6-8 and B are 0.040" (1.02mm) diameter, with 0.080" (2.03mm) diameter standoff shoulders.
- Pins 5 and 9 are 0.080" (2.03 mm) diameter with 0.125" (3.18 mm) diameter standoff shoulders.
- All Pins: Material - Copper Alloy; Finish - Matte Tin over Nickel plate
- Undimensioned components are shown for visual reference only.
- Weight: 5.1oz (144g)
- All dimensions in inches (mm).  
Tolerances:  
x.xx +/-0.02 in. (x.x +/-0.5mm)  
x.xxx +/-0.010 in. (x.xx +/-0.25mm)  
unless otherwise noted.
- Workmanship: Meets or exceeds IPC-A-610C Class II

### PIN DESIGNATIONS

Pin	Name	Function
1	Vin(+)	Positive input voltage
2	ON/OFF	TTL input to turn converter on and off, referenced to Vin(-), with internal pull up.
B	SHARE(+)	Active current share differential pair (See note 4)
3	SHARE(-)	
4	Vin(-)	Negative input voltage
5	Vout(-)	Negative output voltage
6	SENSE(-)	Negative remote sense (See note 1)
7	TRIM	Output voltage trim (See note 2)
8	SENSE(+)	Positive remote sense (See note 3)
9	Vout(+)	Positive output voltage

#### Notes:

- SENSE(-) should be connected to Vout(-) either remotely or at the converter.
- Leave TRIM pin open for nominal output voltage.
- SENSE(+) should be connected to Vout(+) either remotely or at the converter.
- Full-Featured option only. Pin 3 and Pin B not populated on standard model.

### PART NUMBERING SYSTEM

The part numbering system for SynQor's dc-dc converters follows the format shown in the example below.

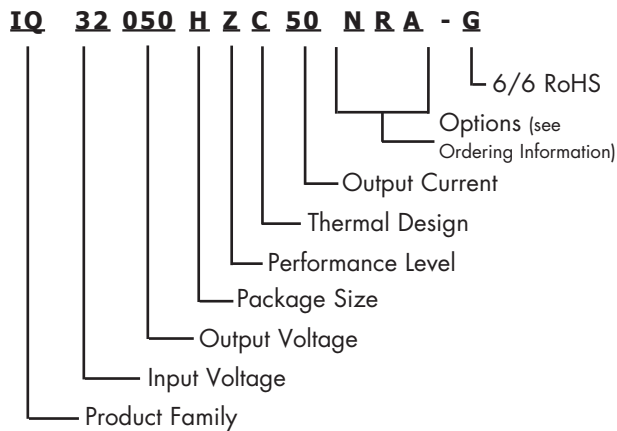

The first 12 characters comprise the base part number and the last 3 characters indicate available options. The "-G" suffix indicates 6/6 RoHS compliance.

### Application Notes

A variety of application notes and technical white papers can be downloaded in pdf format from our [website](#).

**RoHS Compliance:** The EU led RoHS (Restriction of Hazardous Substances) Directive bans the use of Lead, Cadmium, Hexavalent Chromium, Mercury, Polybrominated Biphenyls (PBB), and Polybrominated Diphenyl Ether (PBDE) in Electrical and Electronic Equipment. This SynQor product is 6/6 RoHS compliant. For more information please refer to SynQor's RoHS addendum available at our [RoHS Compliance / Lead Free Initiative web page](#) or e-mail us at [rohs@synqor.com](mailto:rohs@synqor.com).

### Contact SynQor for further information and to order:

**Phone:** 978-849-0600  
**Toll Free:** 888-567-9596  
**Fax:** 978-849-0602  
**E-mail:** [power@synqor.com](mailto:power@synqor.com)  
**Web:** [www.synqor.com](http://www.synqor.com)  
**Address:** 155 Swanson Road  
 Boxborough, MA 01719  
 USA

### ORDERING INFORMATION

The tables below show the valid model numbers and ordering options for converters in this product family. When ordering SynQor converters, please ensure that you use the complete 15 character part number consisting of the 12 character base part number and the additional characters for options. Add "-G" to the model number for 6/6 RoHS compliance.

Model Number	Input Voltage	Output Voltage	Max Output Current
<b>IQ32050HZw50xyz</b>	<b>9-75 V</b>	<b>5.0 V</b>	<b>50 A</b>
<b>IQ32120HZw21xyz</b>	<b>9-75 V</b>	<b>12 V</b>	<b>21 A</b>
<b>IQ32150HZw17xyz</b>	<b>9-75 V</b>	<b>15 V</b>	<b>17 A</b>
<b>IQ32240HZw10xyz</b>	<b>9-75 V</b>	<b>24 V</b>	<b>10 A</b>
<b>IQ32280HZw09xyz</b>	<b>9-75 V</b>	<b>28 V</b>	<b>9 A</b>
<b>IQ32400HZw06xyz</b>	<b>9-75 V</b>	<b>40 V</b>	<b>6 A</b>
<b>IQ32500HZw05xyz</b>	<b>9-75 V</b>	<b>50 V</b>	<b>5 A</b>

The following options must be included in place of the **wxyz** spaces in the model numbers listed above.

Options Description			
Thermal Design	Enable Logic	Pin Style	Feature Set
w	x	y	z
C - Encased D - Encased with Non-Threaded Baseplate V - Encased with Flanged Baseplate	N - Negative	R - 0.180"	A - Standard F - Full-Feature

Not all combinations make valid part numbers, please contact SynQor for availability. See the [Product Summary web page](#) for more options.

### PATENTS

SynQor holds numerous U.S. patents, one or more of which apply to most of its power conversion products. Any that apply to the product(s) listed in this document are identified by markings on the product(s) or on internal components of the product(s) in accordance with U.S. patent laws. SynQor's patents include the following:

6,896,526    6,927,987    7,050,309    7,765,687  
 7,787,261    8,149,597    8,644,027

### Warranty

SynQor offers a two (2) year limited warranty. Complete warranty information is listed on our website or is available upon request from SynQor.