

# SynQor®

## MCOTS-C-28-12D-DM

### Dual Output Demi-brick

## MILITARY COTS DC-DC CONVERTER

<b>16-40V</b> Continuous Input	<b>16-50V</b> Transient Input	<b>±12V</b> Output	<b>4A</b> Total Output	<b>87% @ 2A / 86% @ 4A</b> Efficiency
-----------------------------------	----------------------------------	-----------------------	---------------------------	--

The Mil-COTS DC-DC Converters bring SynQor's field proven high-efficiency synchronous rectification technology to the Military/Aerospace industry. SynQor's ruggedized encased packaging approach ensures survivability in demanding environments. These converters operate at a fixed frequency and follow conservative component derating guidelines. They are designed and manufactured to comply with a wide range of military standards.

## MilCOTS™



### Safety Features

- 1000V, 100MΩ input-to-output isolation
- Certified 60950-1 requirement for basic insulation (see Standards and Qualifications page)

### Mechanical Features

- Demi-brick Pin-out configuration
- Size: 1.55" x 1.52" x 0.50" (39.4 x 38.6 x 12.7 mm)
- Total weight: 1.97 oz. (56 g)
- Flanged baseplate version available

### Control Features

- On/Off control referenced to input return
- Output voltage trim range of +10%, -10%

### Compliance Features

- MilCOTS series converters (With an MCOTS filter) are designed to meet:
- MIL-HDBK-704-8 (A-F)
  - RTCA/DO-160 Section 16
  - MIL-STD-1275 (B, D)
  - MIL-STD-461 (C, D, E, F)
  - DEF-STAN 61-5 (Part 6)/(5 or 6) for  $V_{IN} > 16V$  (with MCOTS-F-28-T-HT)

### Operational Features

- High efficiency, 86% at full rated load current
- Operating input voltage range: 16-40V
- Fixed frequency switching to provide predictable EMI
- Clock synchronization
- No minimum load requirement

### Protection Features

- Input under-voltage lockout
- Output current limit and short circuit protection
- Active back bias limit
- Output over-voltage protection

### Screening/Qualification

- AS9100 & ISO 9001 certified facility
- Qualification consistent with MIL-STD-810
- Available with S-Grade or M-Grade screening
- Temperature cycling per MIL-STD-883, Method 1010, Condition B, 10 cycles
- Burn-In at 100C baseplate temperature
- Final visual inspection per MIL-STD-2008
- Full component traceability



**MCOTS-C-28-12D-DM**

**Input: 16-40V**

**Output: ±12V**

**Current: 4A Total**

## Block Diagram

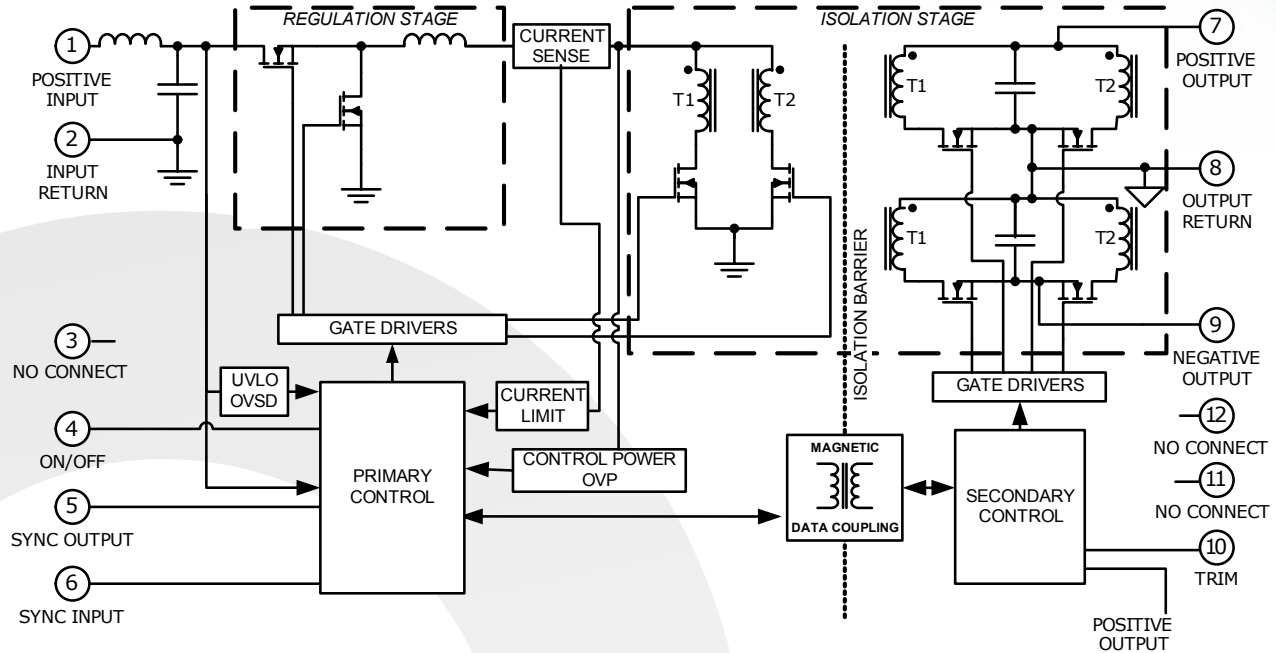

## Typical Connection Diagram

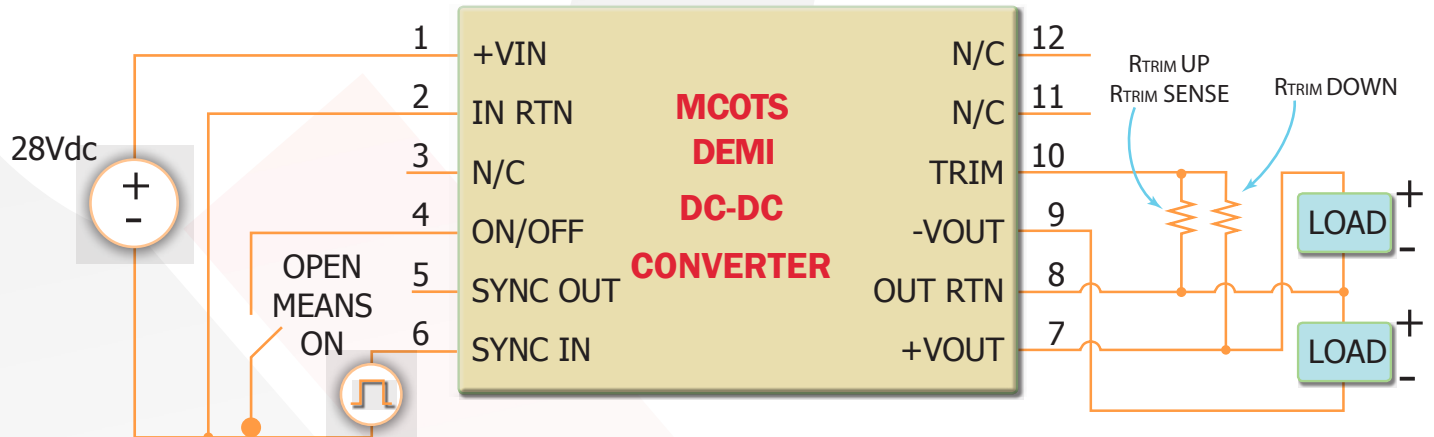



**MCOTS-C-28-12D-DM**  
**Input: 16-40V**  
**Output: ±12V**  
**Current: 4A Total**

## Electrical Characteristics

### MCOTS-C-28-12D-DM ELECTRICAL CHARACTERISTICS

Tb = 25 °C, Vin = 28 Vdc, +Iout = -Iout = 2A, free running (see Note 8) unless otherwise specified; full operating temperature range is -55 °C to +100 °C baseplate temperature with appropriate power derating. Specifications subject to change without notice.

Parameter	Min.	Typ.	Max.	Units	Notes & Conditions
<b>ABSOLUTE MAXIMUM RATINGS</b>					
Input Voltage					
Non-Operating	-1		60	V	Continuous
Operating			40	V	Continuous
Operating Transient Protection			60	V	See Note 1
Isolation Voltage					
Input to Output			1000	V	
Input to Base-Plate			1000	V	
Output to Base-Plate			1000	V	
Operating Case Temperature	-55		100	°C	Baseplate temperature
Storage Case Temperature	-65		135	°C	
Voltage at ON/OFF	-1.2		50	V	
<b>INPUT CHARACTERISTICS</b>					
Operating Input Voltage Range	16	28	40	V	
Input Under-Voltage Shutdown					See Note 3
Turn-On Voltage Threshold	14.75	15.50	16.00	V	
Turn-Off Voltage Threshold	14.00	14.75	15.50	V	
Shutdown Voltage Hysteresis		0.80		V	
Input Over-Voltage Shutdown					See Note 3
Turn-Off Voltage Threshold	52.0	55.0	58.0	V	
Turn-On Voltage Threshold	50.5	54.0	56.5	V	
Shutdown Voltage Hysteresis		2.0		V	
Input Filter Component Values (L\C)		1.0\11.47		µH\µF	Internal values; see Figure F
Maximum Input Current			3.9	A	Vin = 16V; +Iout = -Iout = 2A
No Load Input Current		75	125	mA	
Disabled Input Current		10	15	mA	
Input Terminal Current Ripple (pk-pk)		40	75	mA	Bandwidth = 100kHz – 10MHz; see Figure 14
<b>OUTPUT CHARACTERISTICS</b>					
Output Voltage Set Point					
Positive Output	11.88	12.00	12.12	V	
Negative Output	-12.12	-12.00	-11.88	V	
Positive Output Voltage Regulation				mV	
Over Line	-0.4	0	0.4	%	
Over Load	-0.4	0	0.4	%	+Vout @(+Iout=-Iout=0A) - +Vout @(+Iout=-Iout=2A)
Over Temperature	-180	0	180	mV	
Output Voltage Cross Regulation		400		mV	-Vout@(+Iout=-Iout=0.8A) - -Vout@(+Iout=3.2A,-Iout=0.8A)
Total Positive Output Voltage Range	11.76	12.00	12.24	V	Over sample, line, load, temperature & life
Output Voltage Ripple and Noise Peak to Peak		15	75	mV	Bandwidth = 10MHz; CL=11µF
Operating Output Current Range	0		4	A	(+Iout) + (-Iout)
Single Output Operating Current Range	0		3.2	A	Maximum +Iout or -Iout
Operating Output Power Range	0		48	W	Total on both outputs
Output DC Current-Limit Inception	4.2	4.8	5.8	A	See Note 4; +Iout + -Iout; +Iout = -Iout
Back-Drive Current Limit while Enabled		1.2		A	
Back-Drive Current Limit while Disabled		10		mA	
Maximum Output Capacitance			1500	µF	
Output Voltage Deviation Load Transient					See Note 5
For a Pos. Step Change in Load Current		-600		mV	Total Iout step = 2A to 4A, 0.4A to 2A; CL=11µF on both Vouts
Settling Time		200		µs	
Response to Input Transient		0.2		V	See Note 6
Output Voltage Trim Range	-10		10	%	See Figure E
Output Over-Voltage Shutdown	14.9	17.5	18.9	V	



**MCOTS-C-28-12D-DM**  
**Input: 16-40V**  
**Output: ±12V**  
**Current: 4A Total**

## Electrical Characteristics

### MCOTS-C-28-12D-DM ELECTRICAL CHARACTERISTICS (Continued)

Tb = 25 °C, Vin = 28 Vdc, +Iout = -Iout = 2A, free running (see Note 8) unless otherwise specified; full operating temperature range is -55 °C to +100 °C baseplate temperature with appropriate power derating. Specifications subject to change without notice.

Parameter	Min.	Typ.	Max.	Units	Notes & Conditions
<b>EFFICIENCY</b>					
Iout = 4 A (28 Vin)		86		%	
Iout = 2 A (28 Vin)		87		%	
<b>ISOLATION CHARACTERISTICS</b>					
Isolation Voltage (dielectric strength)					See Absolute Maximum Ratings
Isolation Resistance		100		MΩ	
Isolation Capacitance (input to output)		22		nF	
<b>TEMPERATURE LIMITS FOR POWER DERATING CURVES</b>					
Semiconductor Junction Temperature			125	°C	Package rated to 150 °C
Board Temperature			125	°C	UL rated max operating temp 130 °C
Transformer Temperature			125	°C	
Maximum Baseplate Temperature, Tb			100	°C	
<b>FEATURE CHARACTERISTICS</b>					
Switching Frequency (free running)		550		kHz	
Synchronization Input					
Frequency Range	500		700	kHz	
Logic Level High	2.0		5.5	V	
Logic Level Low	-0.5		0.8	V	
Duty Cycle	20		80	%	
Synchronization Output					
Pull Down Current	20			mA	VSYNC OUT = 0.8V
Duty Cycle	40		60	%	Output connected to SYNC IN of other units
ON/OFF Control					
Off-State Voltage			0.8	V	
Module Off Pulldown Current	80			μA	Current drain required to ensure module is off
On-State Voltage	2			V	
Module On Pin Leakage Current			20	μA	Imax draw from pin allowed with module still on
Pull-Up Voltage	3.2	4.0	4.8	V	See Figure A
<b>DYNAMIC CHARACTERISTICS</b>					
Turn-On Transient					
Output Voltage Rise Time		6	10	ms	+Vout = 1.2V to 10.8V; Full Resistive Load
Output Voltage Overshoot		0	2	%	Resistive load
Turn-On Delay, Rising Vin		5.5	8.0	ms	On/Off = 5V; see Notes 7 & 2
Turn-On Delay, Rising ON/OFF		3.0	6.0	ms	See Note 2, see Note 9
Restart Inhibit Time		100	150	ms	See Note 2, see Note 9
Short Circuit Start Time	12	14	20	ms	
<b>RELIABILITY CHARACTERISTICS</b>					
Calculated MTBF per MIL-HDBK-217F		3.9		10 <sup>6</sup> Hrs.	Ground Benign, 70°C Tb
Calculated MTBF per MIL-HDBK-217F		0.79		10 <sup>6</sup> Hrs.	Ground Mobile, 70°C Tb

#### Electrical Characteristics Notes

1. Converter will undergo input over-voltage shutdown.
2. After a disable or fault event, module is inhibited from restarting for 100ms. See Shut Down section of the Control Features description.
3. High or low state of input voltage must persist for about 200μs to be acted on by the shutdown circuitry.
4. Current limit inception is defined as the point where the output voltage has dropped to 90% of its nominal value.  
See Current Limit discussion in Features Description section.
5. Load current transition time ≥ 10μs.
6. Line voltage transition time ≥ 100μs.
7. Input voltage rise time ≤ 250μs.
8. Operating the converter at a synchronization frequency above the free running frequency will cause the converter's efficiency to be slightly reduced and it may also cause a slight reduction in the maximum output current/power available.
9. Time measured at 10% of the rising output voltage.



## Technical Charts

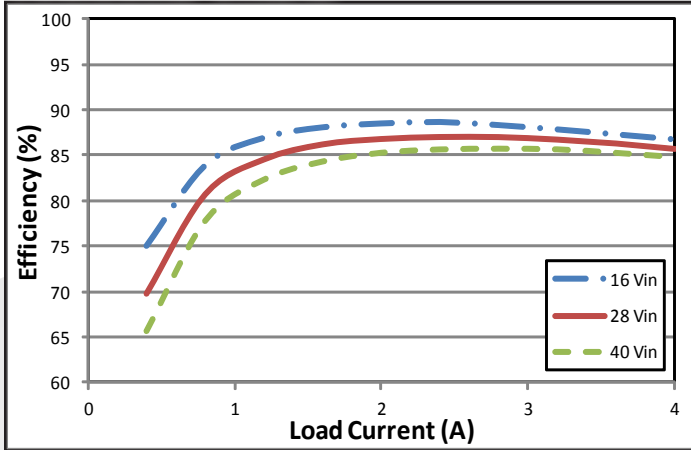

**Figure 1:** Efficiency vs. output power, from zero load to full load with equal load on the +12V and -12V outputs at minimum, nominal, and maximum input voltage at 25°C.

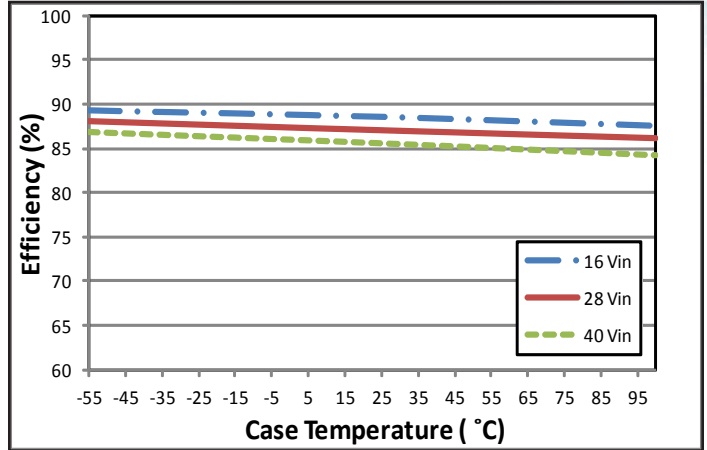

**Figure 2:** Efficiency at 60% load (1.2A load on +12V and 1.2A load on -12V) versus base plate temperature for minimum, nominal, and maximum input voltage.

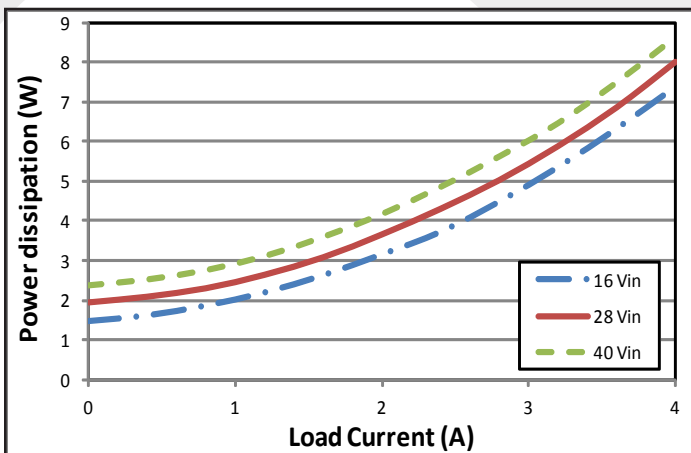

**Figure 3:** Power dissipation vs. output power, from zero load to full load with equal load on the +12V and -12V outputs at minimum, nominal, and maximum input voltage at 25°C.

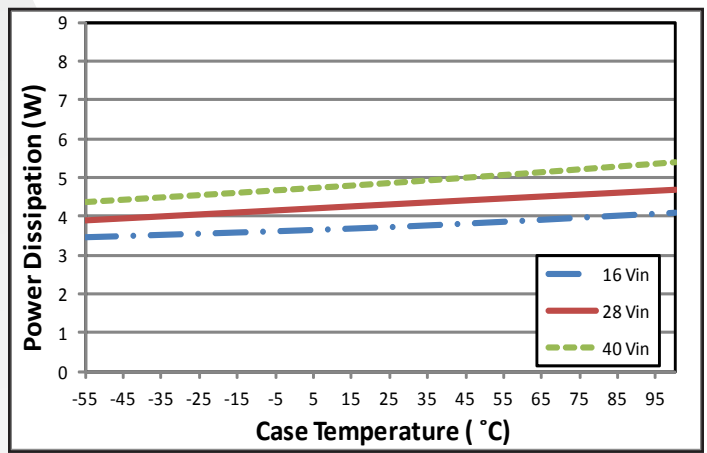

**Figure 4:** Power Dissipation at 60% load (1.2A load on +12V and 1.2A load on -12V) versus base plate temperature for minimum, nominal, and maximum input voltage.

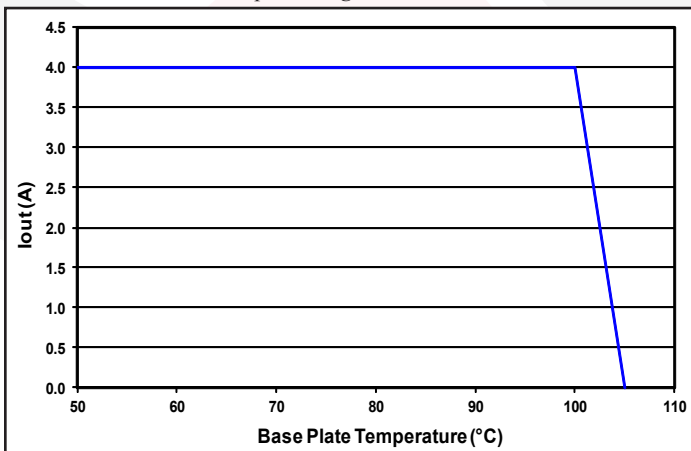

**Figure 5:** Maximum total output current vs. base plate temperature (nominal input voltage).

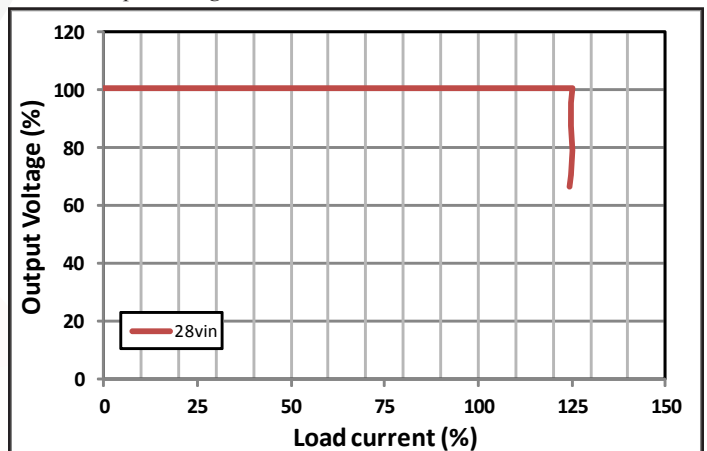

**Figure 6:** Output voltage vs. total load current showing typical current limit curves, evenly split. See Current limit section in application notes.



## Technical Charts

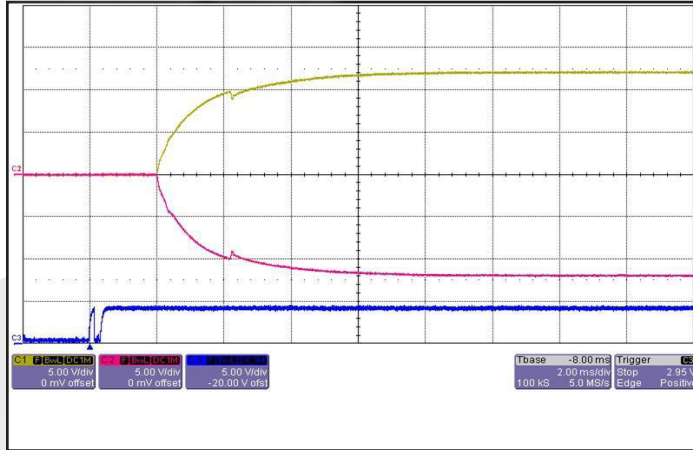

**Figure 7:** Turn-on transient at no load and zero output capacitance initiated by On/Off. Input voltage pre-applied. Ch 1: +Vout (5V/div.) Ch 2: -Vout (5V/div.) Ch 3: On/Off (5V/div.)

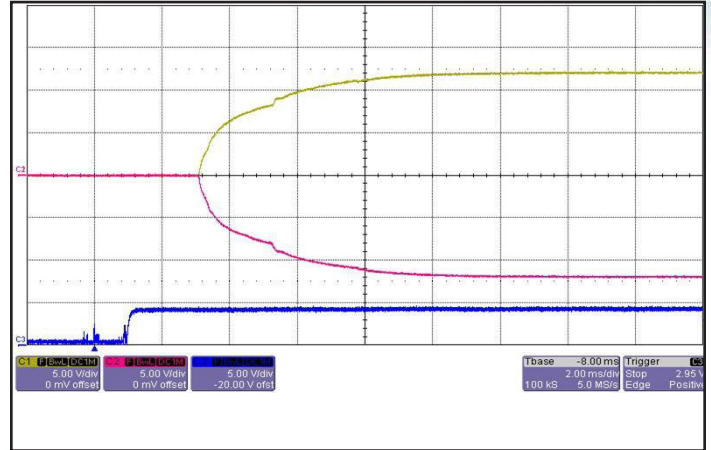

**Figure 8:** Turn-on transient at full load and zero output capacitance initiated by On/Off. Input voltage pre-applied. Ch 1: +Vout (5V/div.) Ch 2: -Vout (5V/div.) Ch 3: On/Off (5V/div.)

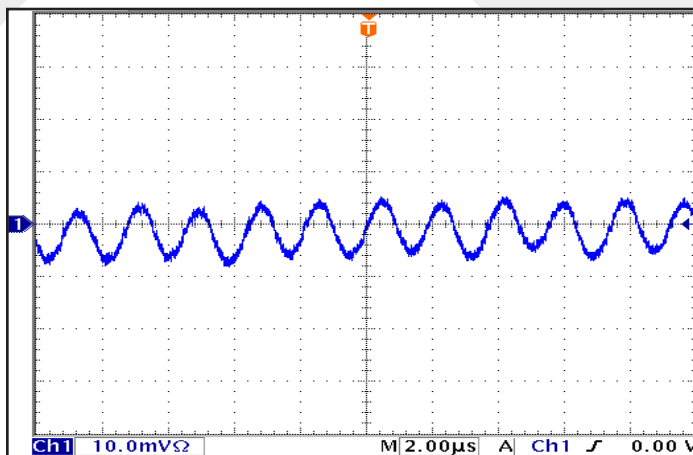

**Figure 9:** Input terminal current ripple, at full rated output current and nominal input voltage with SynQor MCOTS filter module(10mA/div.) See Figure 20.

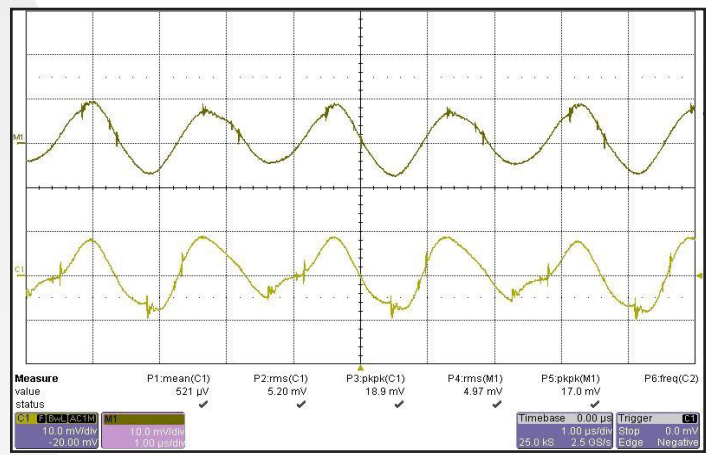

**Figure 10:** Output voltage ripple, Vout, at nominal input voltage and full rated load current. M1: +Vout (10mV/div.) Ch 1: -Vout (10mV/div.)

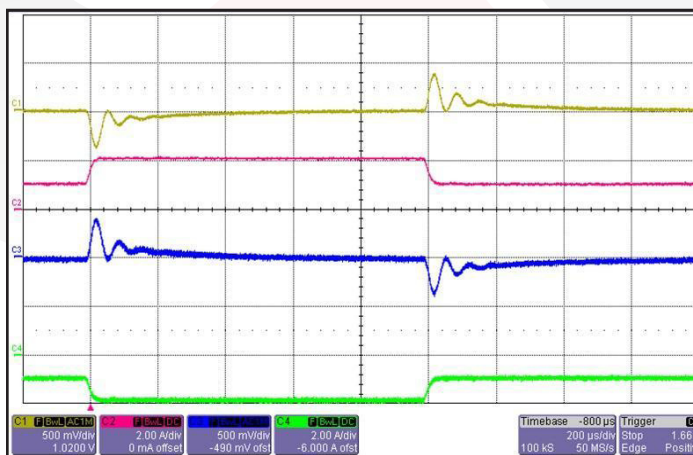

**Figure 11:** Output voltage response to step-change in load current 50%-100%-50% of Iout (max). No external load capacitance. Ch 1: +Vout (500mV/div.) Ch 2: +Iout (2A/div.) Ch 3: -Vout (500mV/div.) Ch 4: -Iout (2A/div.)

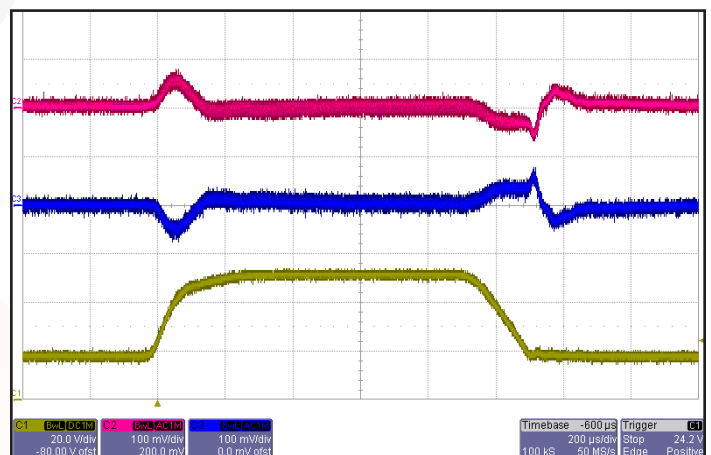

**Figure 12:** Output voltage response to step-change in input voltage (16V - 50V - 16V). Ch 1: +Vin (20V/div.) Ch 2: +Vout (100mV/div.); Ch 3: -Vout (100mV/div.)



## Technical Charts

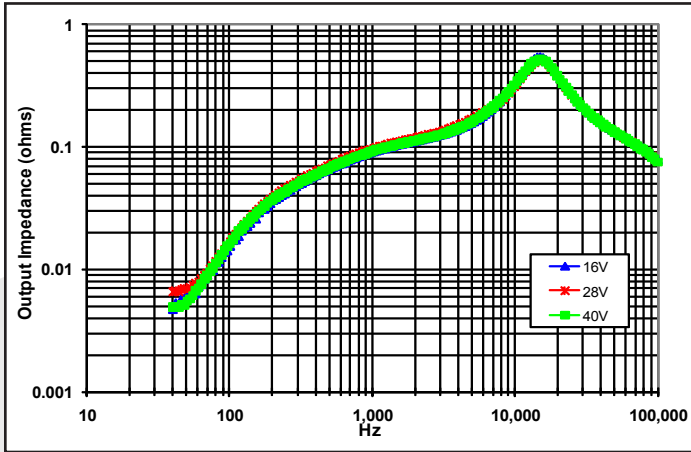

**Figure 13:** Magnitude of incremental output impedance ( $-Z_{out} = +v_{out}/+i_{out}$ ) for minimum, nominal, and maximum input voltage at full rated power.

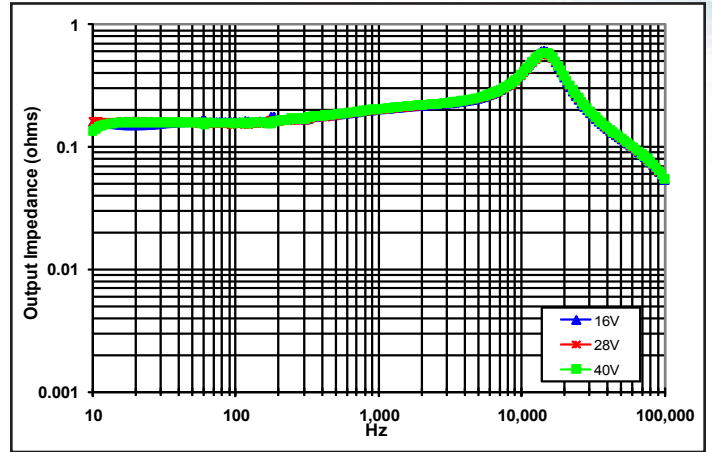

**Figure 14:** Magnitude of incremental output impedance ( $-Z_{out} = -v_{out}/-i_{out}$ ) for minimum, nominal, and maximum input voltage at full rated power.

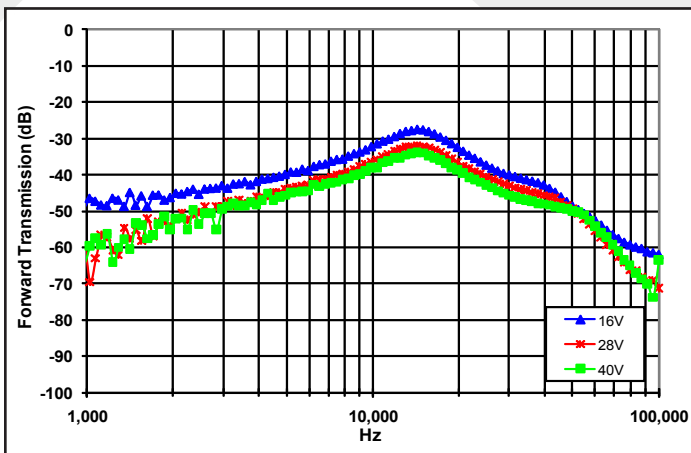

**Figure 15:** Magnitude of incremental forward transmission ( $+FT = +v_{out}/+v_{in}$ ) for minimum, nominal, and maximum input voltage at full rated power.

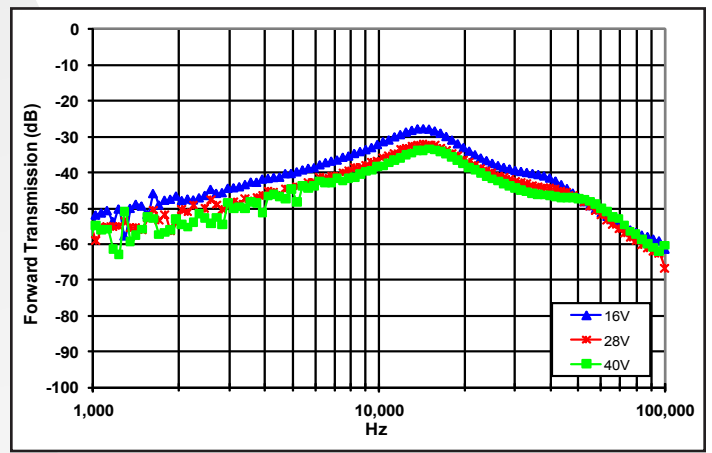

**Figure 16:** Magnitude of incremental forward transmission ( $-FT = -v_{out}/-v_{in}$ ) for minimum, nominal, and maximum input voltage at full rated power.

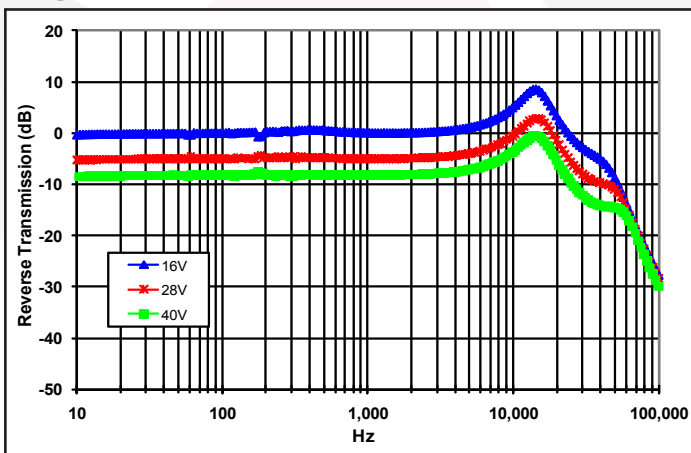

**Figure 17:** Magnitude of incremental reverse transmission ( $+RT = +i_{in}/+i_{out}$ ) for minimum, nominal, and maximum input voltage at full rated power.

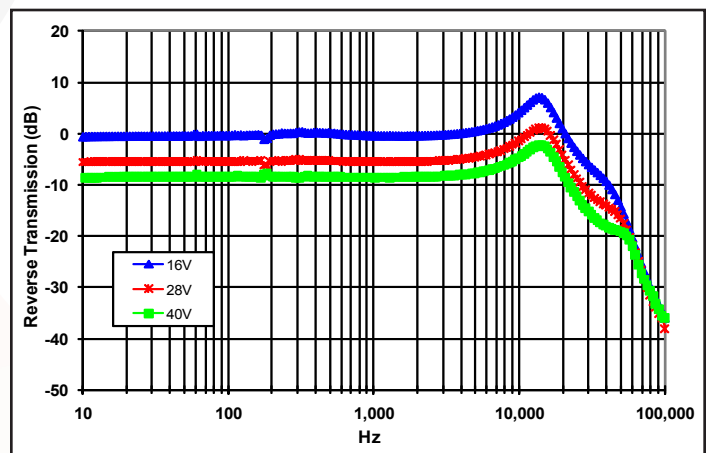

**Figure 18:** Magnitude of incremental reverse transmission ( $-RT = -i_{in}/-i_{out}$ ) for minimum, nominal, and maximum input voltage at full rated power.



## Technical Charts

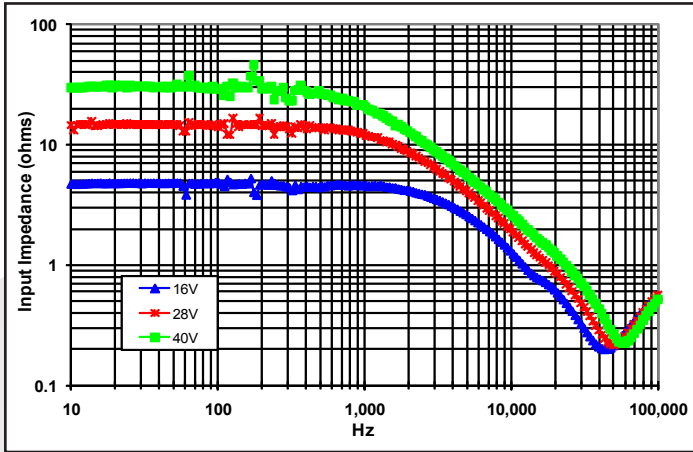

Figure 19: Magnitude of incremental input impedance ( $Z_{in} = v_{in}/i_{in}$ ) for minimum, nominal, and maximum input voltage at full rated power.

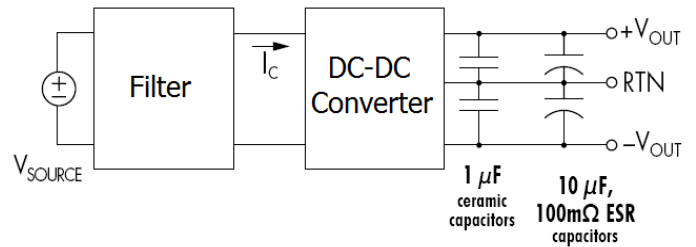

Figure 20: Test set-up diagram showing measurement points for Input Terminal Ripple Current (Figure 9) and Output Voltage Ripple (Figure 10).

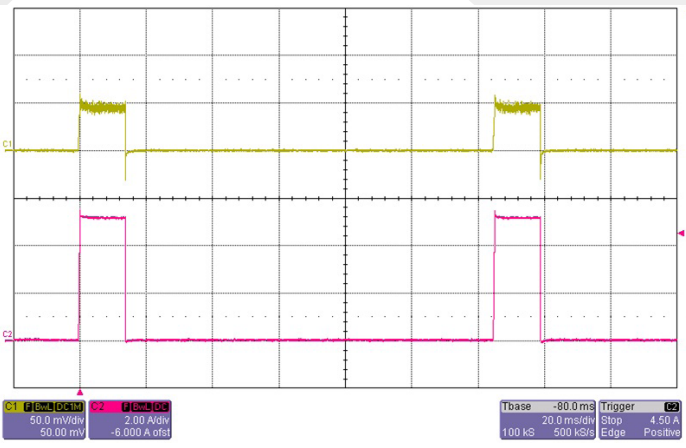

Figure 21: A short circuit across the output terminals. Ch 1:  $V_{out}$  (50mV/div). Ch 2:  $I_{out}$  (2A/div).

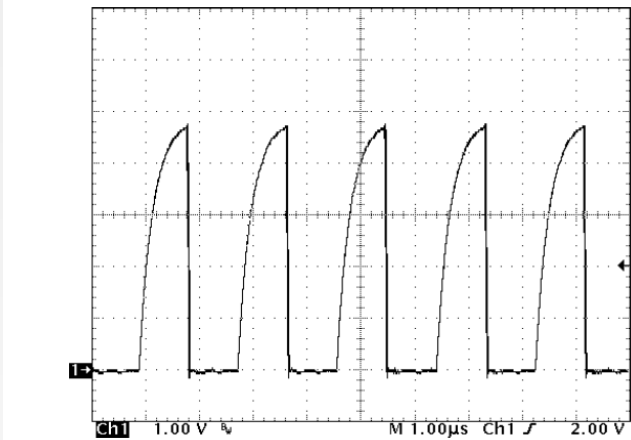

Figure 22: SYNC OUT vs. time, driving Sync IN of a second SynQor converter

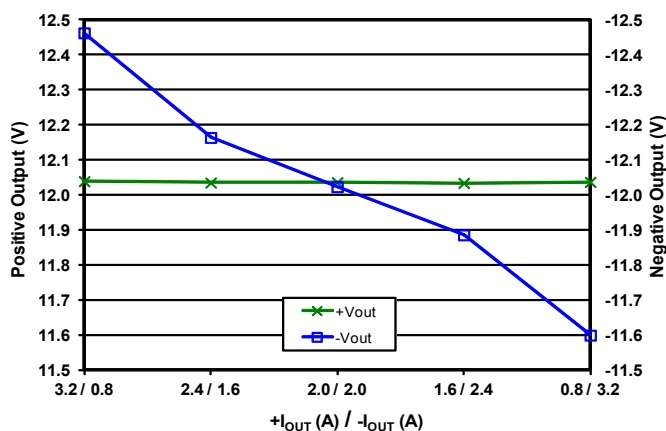

Figure 23: Load regulation vs. load current with power fixed at full load (50W) and load currents split as shown between the +12V and -12V outputs, at nominal input voltage and at 25°C.

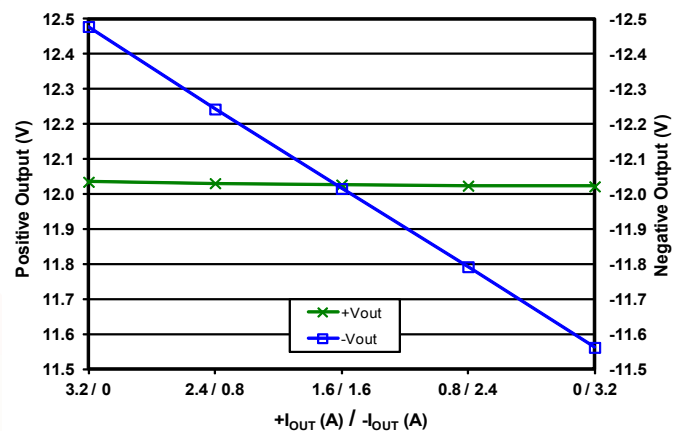

Figure 24: Load regulation vs. load current with power fixed at 80% load (40W) and load currents split as shown between the +12V and -12V outputs, at nominal input voltage and at 25°C.





**MCOTS-C-28-12D-DM**  
**Input: 16-40V**  
**Output: ±12V**  
**Current: 4A Total**

## Application Section

### BASIC OPERATION AND FEATURES

The MCOTS DC-DC converter uses a two-stage power conversion topology. The first, or regulation, stage is a buck-converter that keeps the output voltage constant over variations in line, load, and temperature. The second, or isolation, stage uses transformers to provide the functions of input/output isolation and voltage transformation to achieve the output voltage required.

In the dual output converter there are two secondary windings in the transformer of the isolation stage, one for each output. There is only one regulation stage, however, and it is used to control the positive output. The negative output therefore displays "Cross-Regulation", meaning that its output voltage depends on how much current is drawn from each output.

Both the positive and the negative outputs share a common OUTPUT RETURN pin.

Both the regulation and the isolation stages switch at a fixed frequency for predictable EMI performance. The isolation stage switches at one half the frequency of the regulation stage, but due to the push-pull nature of this stage it creates a ripple at double its switching frequency. As a result, both the input and the output of the converter have a fundamental ripple frequency of about 550 kHz in the free-running mode.

Rectification of the isolation stage's output is accomplished with synchronous rectifiers. These devices, which are MOSFETs with a very low resistance, dissipate far less energy than would Schottky diodes. This is the primary reason why the MCOTS converters have such high efficiency, particularly at low output voltages.

Besides improving efficiency, the synchronous rectifiers permit operation down to zero load current. There is no longer a need for a minimum load, as is typical for converters that use diodes for rectification. The synchronous rectifiers actually permit a negative load current to flow back into the converter's output terminals if the load is a source of short or long term energy. The MCOTS converters employ a "back-drive current limit" to keep this negative output terminal current small.

There is a control circuit in the MCOTS converter that determines the conduction state of the power switches. It communicates across the isolation barrier through a magnetically coupled device. No opto-isolators are used.

An input under-voltage shutdown feature with hysteresis is provided, as well as an input over-voltage shutdown and an output over-voltage limit. There is also an output current limit that is nearly constant as the load impedance decreases (i.e., there is not fold-back or fold-forward characteristic to the output current under this condition). When a load fault is removed, the output voltage rises exponentially to its nominal value without an overshoot. If a load fault pulls the output voltage below about 60% of nominal, the converter will shut down to attempt to clear the load fault. After a short delay it will try to auto-restart.

The MCOTS converter's control circuit does not implement an over-temperature shutdown.

The following sections describe the use and operation of additional control features provided by the MCOTS converter.

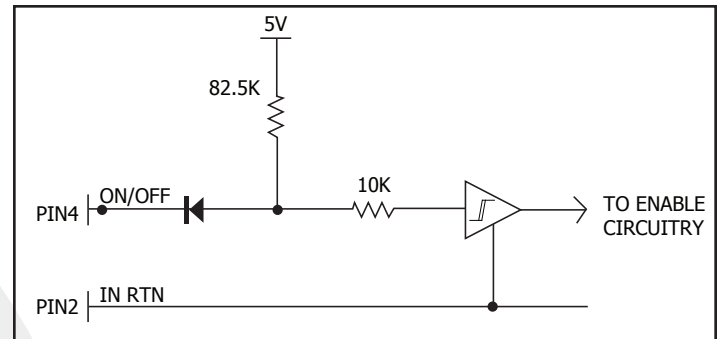

Figure A: Circuit diagram shown for reference only; actual circuit components may differ from values shown for equivalent circuit.

### CONTROL FEATURES

**Remote ON/OFF:** The MCOTS converter has one on/off function pin, ON/OFF (pin 4), which is referenced with respect to the converter's input return (pin 2). It must have a logic high level for the converter to be enabled; a logic low inhibits the converter.

The ON/OFF pin is internally pulled high so that an open connection will enable the converter. Figure A shows the equivalent circuit looking into the ON/OFF pin. It is TTL compatible and has hysteresis.

**SHUT DOWN:** The MCOTS converter will shut down in response to only five conditions: ON/OFF input low, VIN input below under-voltage shutdown threshold, VIN input above over-voltage shutdown threshold, output voltage below the output under-voltage threshold, and output voltage above the output over-voltage threshold. Following any shutdown event, there is a startup inhibit delay which will prevent the converter from restarting for approximately 100ms. After the 100ms delay elapses, if the ON/OFF inputs are high and the input voltage is within the operating range, the converter will restart. If the VIN input is brought down to nearly 0V and back into the operating range, there is no startup inhibit, and the output voltage will rise according to the "Turn-On Delay, Rising Vin" specification.

**SYNCHRONIZATION:** The MCOTS converter's switching frequency can be synchronized to an external frequency source that is in the 500 kHz to 700 kHz range. A pulse train at the desired frequency should be applied to the SYNC IN pin (pin 6) with respect to the INPUT RETURN (pin 2). This pulse train should have a duty cycle in the 20% to 80% range. Its low value should be below 0.8V to be guaranteed to be interpreted as a logic low, and its high value should be above 2.0V to be guaranteed to be interpreted as a logic high. The transition time between the two states should be less



## Application Section

than 300ns.

If the MCOTS converter is not to be synchronized, the SYNC IN pin should be left open circuit. The converter will then operate in its free-running mode at a frequency of approximately 550 kHz.

If, due to a fault, the SYNC IN pin is held in either a logic low or logic high state continuously, or the SYNC IN frequency is outside the 500-700 kHz range, the MCOTS converter will revert to its free-running frequency.

The MCOTS converter also has a SYNC OUT pin (pin 5). This output can be used to drive the SYNC IN pins of as many as ten (10) other MCOTS converters. The pulse train coming out of SYNC OUT has a duty cycle of 50% and a frequency that matches the switching frequency of the converter with which it is associated. This frequency is either the free-running frequency if there is no valid synchronization signal at the SYNC IN pin, or the synchronization frequency if there is.

Figure B shows the equivalent circuit looking into the SYNC IN pin and Figure C shows the equivalent circuit looking into the SYNC OUT pin.

**OUTPUT VOLTAGE TRIM:** The TRIM pin (pin 11) can adjust the MCOTS converter's output voltage  $\pm 10\%$  around its nominal value.

To trim the output voltage above its nominal value, connect an external resistor from the TRIM pin to the OUTPUT RETURN pin as shown in Figure D. The value of this trim up resistor should be chosen according to the following equation or from Figure E:

$$R_{\text{trim up}}(\Omega) = \frac{7900\Omega \cdot V_{\text{nom}}}{V_{\text{out}} - V_{\text{nom}}} - 39600\Omega$$

where:

$V_{\text{nom}}$  = the converter's nominal output voltage,  
 $V_{\text{out}}$  = the desired output voltage (greater than  $V_{\text{nom}}$ ),  
 and  
 $R_{\text{trim up}}$  is in Ohms.

As the output voltage is trimmed up, it produces a greater voltage stress on the converter's internal components and may cause the converter to fail to deliver the desired output voltage at the low

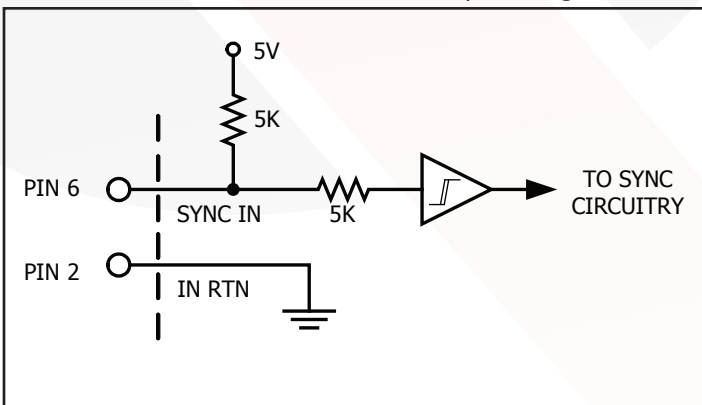

Figure B: Equivalent circuit looking into the SYNC IN pin with respect to the IN RTN (input return) pin.

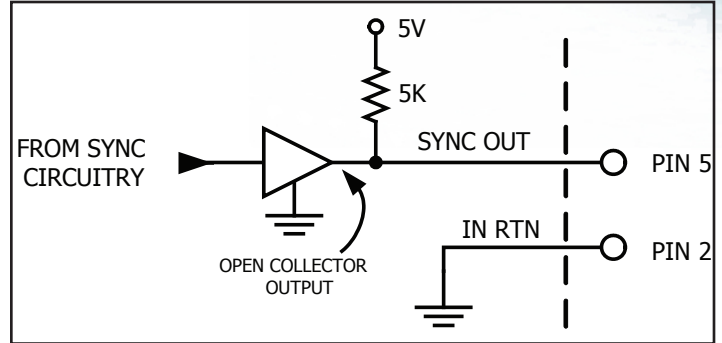

Figure C: Equivalent circuit looking into SYNC OUT pin with respect to the IN RTN (input return) pin.

end of the input voltage range at the higher end of the load current and temperature range. Please consult the factory for details. To trim the output voltage below its nominal value, connect an external resistor ( $R_{\text{trim down}}$ ) between the TRIM pin and the POSITIVE OUTPUT pin, and another resistor ( $R_{\text{trim sense}}$ ) connected between the TRIM pin and the OUTPUT RETURN pin as shown in Figure D. The value of this trim down resistor should be chosen according to the following equation or from Figure E:

$$R_{\text{trim down}}(\Omega) = \frac{38100\Omega \cdot V_{\text{out}} - 20900\Omega \cdot V_{\text{nom}}}{V_{\text{nom}} - V_{\text{out}}} - 104500\Omega$$

$$R_{\text{trim sense}}(\Omega) = 0.61 \cdot R_{\text{trim down}}(\Omega)$$

where:

$V_{\text{nom}}$  = the converter's nominal output voltage,  
 $V_{\text{out}}$  = the desired output voltage (less than  $V_{\text{nom}}$ ),  
 and  
 $R_{\text{trim down}}$  and  $R_{\text{trim sense}}$  are in Ohms.

**INPUT UNDER-VOLTAGE SHUTDOWN:** The MCOTS converter has an under-voltage shutdown feature that ensures the converter will be off if the input voltage is too low. The input voltage turn-on threshold is higher than the turn-off threshold. In addition, the MCOTS converter will not respond to a state of the input voltage unless it has remained in that state for more than about 200 $\mu$ s. This hysteresis and the delay ensure proper operation when the source impedance is high or in a noisy environment.

**INPUT OVER-VOLTAGE SHUTDOWN:** The MCOTS converter also has an over-voltage feature that ensures the converter will be off if the input voltage is too high. It also has a hysteresis and time delay to ensure proper operation.

**OUTPUT OVER-VOLTAGE SHUTDOWN:** The MCOTS converter will shut down if the voltage at its power output pins ever exceeds about 130% of the nominal value. The shutdown threshold does not change with output trim or sense drops; excessive trim-up or output wiring drops may cause an output over-voltage shutdown event. After a startup inhibit delay, the converter will attempt to restart.



## Application Section

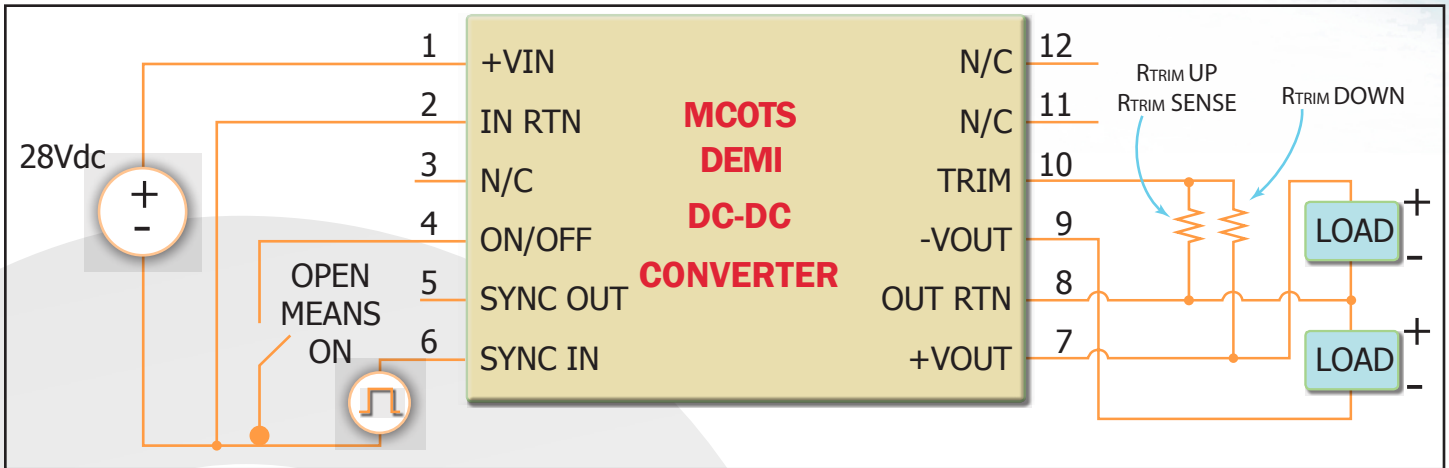

Figure D: Typical connection for output voltage trimming.

**OUTPUT UNDER-VOLTAGE SHUTDOWN:** The MCOTS converter will also shut down if the voltage at its power output pins ever dips below 60% of the nominal value for more than a few milliseconds. Output voltage reduction due to output current overload (current limit) is the most common trigger for this shutdown. The shutdown threshold does not change with output trim but at only 10%, trim-down should not trigger this event. After a startup inhibit delay, the converter will attempt to restart. This shutdown is disabled during startup.

**BACK-DRIVE CURRENT LIMIT:** Converters that use MOSFETs as synchronous rectifiers are capable of drawing a negative current from the load if the load is a source of short- or long-term energy. This negative current is referred to as a “back-drive current”.

Conditions where back-drive current might occur include paralleled converters that do not employ current sharing. It can also occur when converters having different output voltages are connected together through either explicit or parasitic diodes that, while

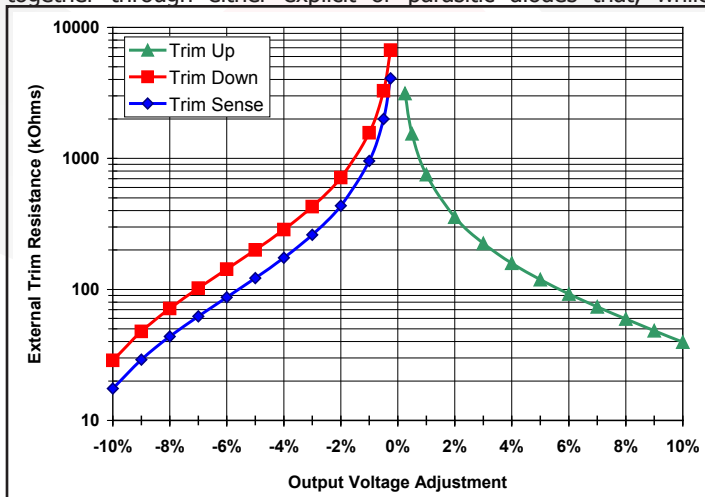

Figure E: Trim up and Trim down as a function of external trim resistance.

normally off, become conductive during startup or shutdown. Finally, some loads, such as motors, can return energy to their power rail. Even a load capacitor is a source of back-drive energy for some period of time during a shutdown transient.

To avoid any problems that might arise due to back-drive current, the MCOTS converters limit the negative current that the converter can draw from its output terminals. The threshold for this back-drive current limit is placed sufficiently below zero so that the converter may operate properly down to zero load, but its absolute value (see the Electrical Characteristics page) is small compared to the converter’s rated output current.

**CURRENT LIMIT:** In the event of excess load, the MCOTS converter will quickly reduce its output voltage to keep the load current within safe limits (see Figure 6). If the overload persists for more than 14 milliseconds, the converter will shut off, wait a restart delay, and then automatically attempt to re-start. The timeout is internally implemented with an integrator: counting up whenever current limit is active, and counting down at 1/5th the rate whenever current limit becomes inactive. In this way a series of short-duration overloads will not cause the converter to shut down, while it will shut down in response to sustained overloads.

**INPUT SYSTEM INSTABILITY:** This condition can occur because any dc-dc converter appears incrementally as a negative resistance load. A detailed application note titled “Input System Instability” is available on the SynQor website which provides an understanding of why this instability arises, and shows the preferred solution for correcting it.



## Application Section

**THERMAL CONSIDERATIONS:** The maximum operating baseplate temperature,  $T_B$ , is 100°C. Refer to the thermal derating curve, Figure 5, to see the available output current at baseplate temperatures below 100°C.

A power derating curve can be calculated for any heatsink that is attached to the base-plate of the converter. It is only necessary to determine the thermal resistance,  $R_{TH_{BA}}$ , of the chosen heatsink between the base-plate and the ambient air for a given airflow rate. This information is usually available from the heatsink vendor. The following formula can then be used to determine the maximum power the converter can dissipate for a given thermal condition:

$$P_{diss}^{max} = \frac{T_B - T_A}{R_{TH_{BA}}}$$

This value of power dissipation can then be used in conjunction with the data shown in Figure 3 to determine the maximum load current (and power) that the converter can deliver in the given thermal condition.

**INPUT FILTERING AND EXTERNAL CAPACITANCE:** Figure F provides a diagram showing the internal input filter components. This filter dramatically reduces input terminal ripple current, which otherwise could exceed the rating of the converter's external electrolytic input capacitor. More detailed information is available in the application note titled "EMI Characteristics" on the SynQor website.

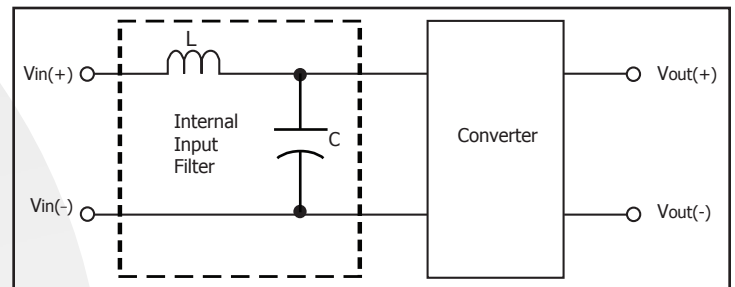
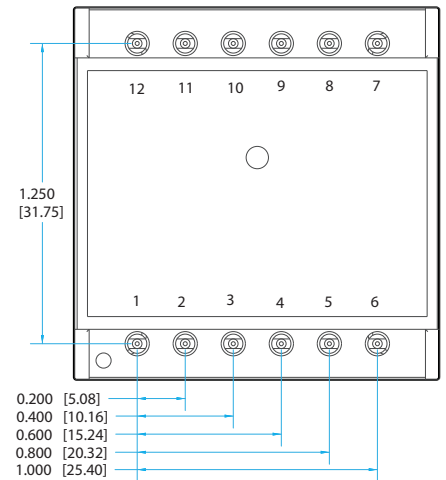
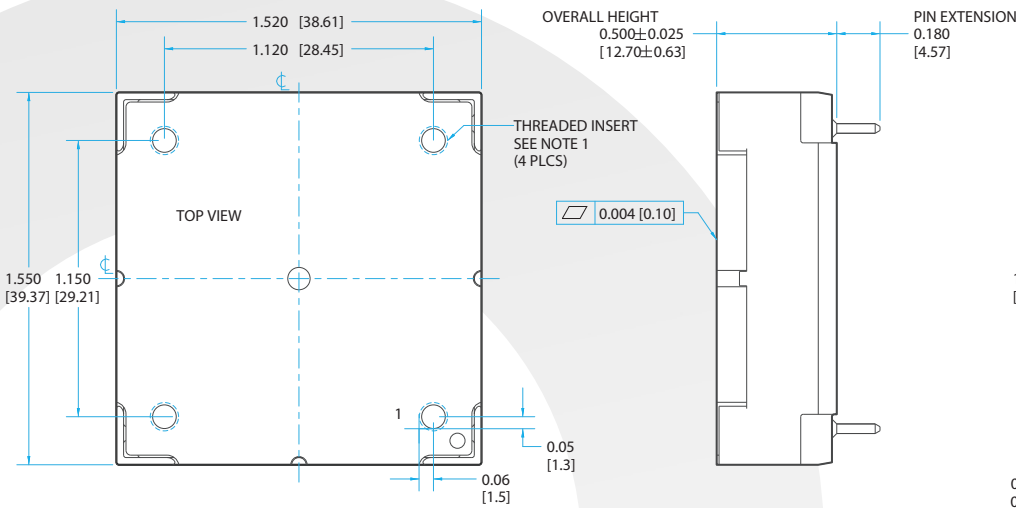

Figure F: Internal Input Filter Diagram.



**MCOTS-C-28-12D-DM**  
**Input: 16-40V**  
**Output: ±12V**  
**Current: 4A Total**

## Encased Mechanical Diagram



### NOTES:

- 1: APPLIED TORQUE PER M3 SCREW  
6in-lb (0.7Nm) RECOMMENDED.  
SCREW SHOULD NOT EXCEED 0.100" (2.54mm)  
DEPTH BELOW THE SURFACE OF THE BASEPLATE.
- 2: BASEPLATE FLATNESS TOLERANCE IS  
0.004" (.10mm) TIR FOR SURFACE.
- 3: PINS 1-12 ARE .040" (1.02mm) DIA, WITH 0.080"  
(2.03mm) DIA. STANDOFF
- 4: ALL PINS: MATERIAL: COPPER ALLOY  
FINISH: MATTE TIN OVER NICKEL PLATE
- 5: WEIGHT: 1.97 oz. (56g)
- 6: ALL DIMENSIONS IN INCHES(mm)  
TOLERANCES: X.XXIN +/-0.02 (X.Xmm +/-0.5mm)  
X.XXXIN +/-0.010 (X.XXmm +/-0.25mm)

### PIN DESIGNATIONS

Pin #	Function
1	Positive input
2	Input return
3	No connection
4	On/Off
5	Sync output
6	Sync input
7	Positive output
8	Output return
9	Negative output
10	Trim
11	No connection
12	No connection

Pin Designation Notes:

- 1: Pin out differs from other  
Mil-COTS products.



**MCOTS-C-28-12D-DM**  
**Input: 16-40V**  
**Output: ±12V**  
**Current: 4A Total**

## Flanged Encased Mechanical Diagram

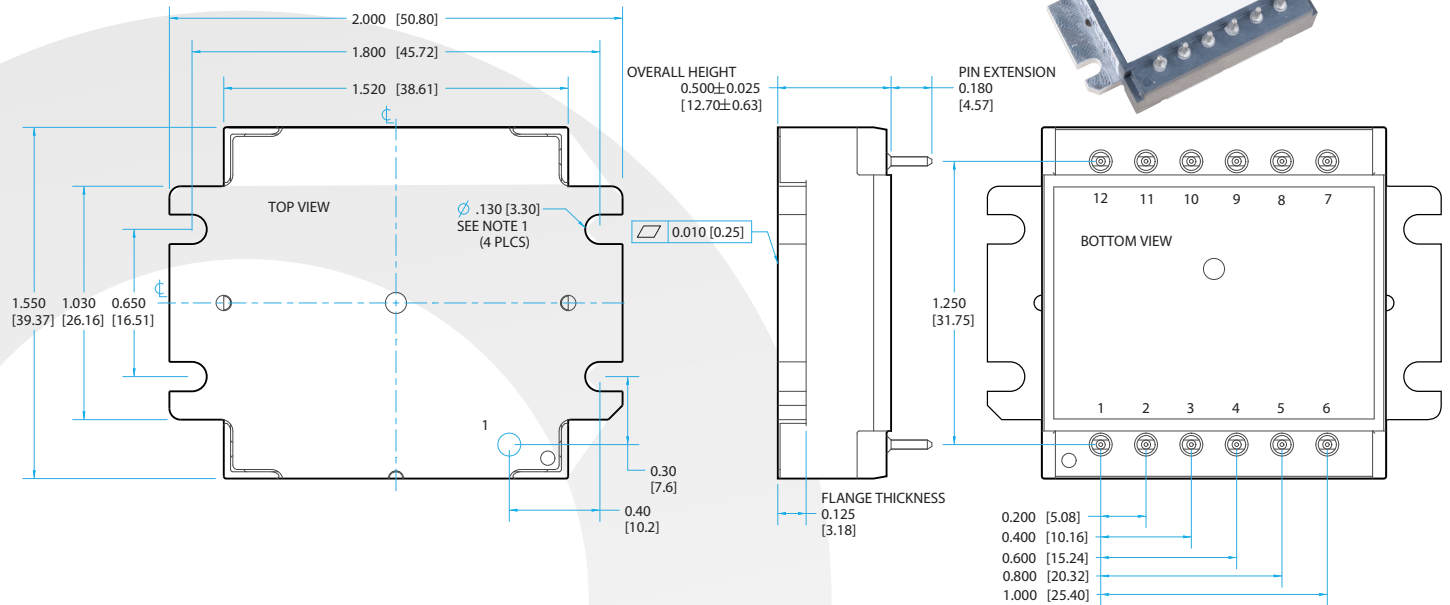
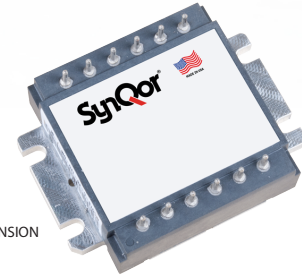

### NOTES:

- 1: APPLIED TORQUE PER M3 OR 4-40 SCREW 6in-lb (0.7Nm) RECOMMENDED.
- 2: BASEPLATE FLATNESS TOLERANCE IS 0.010" (.25mm) TIR FOR SURFACE.
- 3: PINS 1-12 ARE .040" (1.02mm) DIA, WITH 0.080" (2.03mm) DIA. STANDOFF
- 4: ALL PINS: MATERIAL: COPPER ALLOY  
FINISH: MATTE TIN OVER NICKEL PLATE
- 5: WEIGHT: 2.08 oz. (59g)  
ALL DIMENSIONS IN INCHES(mm)
- 6: TOLERANCES: X.XXIN +/-0.02 (X.Xmm +/-0.5mm)  
X.XXXIN +/-0.010 (X.XXmm +/-0.25mm)

### PIN DESIGNATIONS

Pin #	Function
1	Positive input
2	Input return
3	No connection
4	On/Off
5	Sync output
6	Sync input
7	Positive output
8	Output return
9	Negative output
10	Trim
11	No connection
12	No connection

### Pin Designation Notes:

- 1: Pin out differs from other Mil-COTS products.



**MCOTS-C-28-12D-DM**  
**Input: 16-40V**  
**Output: ±12V**  
**Current: 4A Total**

## Qualifications & Screening

### Mil-COTS Qualification

Test Name	Details	# Tested (# Failed)	Consistent with MIL-STD-883F Method
<b>Life Testing</b>	Visual, mechanical and electrical testing before, during and after 1000 hour burn-in @ full load	15 (0)	Method 1005.8
<b>Shock-Vibration</b>	Visual, mechanical and electrical testing before, during and after shock and vibration tests	5 (0)	MIL-STD-202, Methods 201A & 213B
<b>Humidity</b>	+85 °C, 95% RH, 1000 hours, 2 minutes on / 6 hours off	8 (0)	Method 1004.7
<b>Temperature Cycling</b>	500 cycles of -55 °C to +100 °C (30 minute dwell at each temperature)	10 (0)	Method 1010.8, Condition A
<b>Solderability</b>	15 pins	15 (0)	Method 2003
<b>DMT</b>	-65 °C to +110 °C across full line and load specifications in 5 °C steps	7 (0)	
<b>Altitude</b>	70,000 feet (21 km), see Note	2 (0)	

Note: A conductive cooling design is generally needed for high altitude applications because of naturally poor convective cooling at rare atmospheres.

### Mil-COTS Converter and Filter Screening

Screening	Process Description	S-Grade	M-Grade
<b>Baseplate Operating Temperature</b>		-55 °C to +100 °C	-55 °C to +100 °C
<b>Storage Temperature</b>		-65 °C to +135 °C	-65 °C to +135 °C
<b>Pre-Cap Inspection</b>	IPC-A-610, Class III	•	•
<b>Temperature Cycling</b>	MIL-STD-883F, Method 1010, Condition B, 10 Cycles		•
<b>Burn-In</b>	100 °C Baseplate	12 Hours	96 Hours
<b>Final Electrical Test</b>	100%	25 °C	-55 °C, +25 °C, +100 °C
<b>Final Visual Inspection</b>	MIL-STD-883F, Method 2009	•	•

### Mil-COTS MIL-STD-810G Qualification Testing

MIL-STD-810G Test	Method	Description
<b>Fungus</b>	508.6	Table 508.6-I
<b>Altitude</b>	500.5 - Procedure I	Storage: 70,000 ft / 2 hr duration
	500.5 - Procedure II	Operating: 70,000 ft / 2 hr duration; Ambient Temperature
<b>Rapid Decompression</b>	500.5 - Procedure III	Storage: 8,000 ft to 40,000 ft
<b>Acceleration</b>	513.6 - Procedure II	Operating: 15 g
<b>Salt Fog</b>	509.5	Storage
<b>High Temperature</b>	501.5 - Procedure I	Storage: 135 °C / 3 hrs
	501.5 - Procedure II	Operating: 100 °C / 3 hrs
<b>Low Temperature</b>	502.5 - Procedure I	Storage: -65 °C / 4 hrs
	502.5 - Procedure II	Operating: -55 °C / 3 hrs
<b>Temperature Shock</b>	503.5 - Procedure I - C	Storage: -65 °C to 135 °C; 12 cycles
<b>Rain</b>	506.5 - Procedure I	Wind Blown Rain
<b>Immersion</b>	512.5 - Procedure I	Non-Operating
<b>Humidity</b>	507.5 - Procedure II	Aggravated cycle @ 95% RH (Figure 507.5-7 aggravated temp - humidity cycle, 15 cycles)
<b>Random Vibration</b>	514.6 - Procedure I	10 - 2000 Hz, PSD level of 1.5 g <sup>2</sup> /Hz (54.6 g <sub>rms</sub> ), duration = 1 hr/axis
<b>Shock</b>	516.6 - Procedure I	20 g peak, 11 ms, Functional Shock (Operating no load) (saw tooth)
	516.6 - Procedure VI	Bench Handling Shock
<b>Sinusoidal vibration</b>	514.6 - Category 14	Rotary wing aircraft - helicopter, 4 hrs/axis, 20 g (sine sweep from 10 - 500 Hz)
<b>Sand and Dust</b>	510.5 - Procedure I	Blowing Dust
	510.5 - Procedure II	Blowing Sand



**MCOTS-C-28-12D-DM**  
**Input: 16-40V**  
**Output: ±12V**  
**Current: 4A Total**

## Ordering Information

Part Numbering Scheme							
Family	Product	Input Voltage	Output Voltage	Package Size	Heatsink Option	Screening Level	Options
<b>MCOTS</b>	<b>C:</b> Converter	<b>28:</b> 16-40V <b>28E:</b> 16-70V	<b>3R3S:</b> 3.3V Single <b>05S:</b> 5.0V Single <b>12S:</b> 12V Single <b>15S:</b> 15V Single <b>28S:</b> 28V Single <b>05D:</b> 5.0V Dual <b>12D:</b> 12V Dual <b>15D:</b> 15V Dual	<b>DM:</b> Demi Mega	<b>N:</b> Normal Threaded <b>F:</b> Flanged	<b>S:</b> S-Grade <b>M:</b> M-Grade	[ ]: Standard Feature

### Ordering Information / Part Numbering

Example: MCOTS-C-28-12D-DM-N-S  
 Not all combinations make valid part numbers, please contact SynQor for availability.

### Application Notes

A variety of application notes and technical white papers can be downloaded in pdf format from our website.

## STANDARDS COMPLIANCE

Parameter	Notes & Conditions
<b>STANDARDS COMPLIANCE</b>	
UL 60950-1	Basic Insulation
CAN/CSA C22.2 No. 60950-1	
EN 60950-1	

Note: An external input fuse must always be used to meet these safety requirements.

Contact SynQor for official safety certificates on new releases or download from the SynQor website.

### Contact SynQor for further information and to order:

**Phone:** 978-849-0600  
**Toll Free:** 888-567-9596  
**Fax:** 978-849-0602  
**E-mail:** power@synqor.com  
**Web:** [www.synqor.com](http://www.synqor.com)  
**Address:** 155 Swanson Road  
 Boxborough, MA 01719  
 USA

### PATENTS

SynQor holds numerous U.S. patents, one or more of which apply to most of its power conversion products. Any that apply to the product(s) listed in this document are identified by markings on the product(s) or on internal components of the product(s) in accordance with U.S. patent laws. SynQor's patents include the following:

6,545,890 6,894,468 6,896,526 6,927,987 7,050,309 7,085,146  
 7,119,524 7,765,687 7,787,261 8,149,597 8,644,027

### WARRANTY

SynQor offers a two (2) year limited warranty. Complete warranty information is listed on our website or is available upon request from SynQor.