

MILITARY COTS EMI FILTER

-40V to +40V Continuous Input	70A Output Current	7mΩ @ 100°C Max. DC Resistance	>150dB @ 250kHz Differential Attenuation
---	------------------------------	--	---

FULL POWER OPERATION: -55°C to +100°C

The Mil-COTS series of EMI filters brings SynQor's field proven technology and manufacturing expertise to the military and aerospace industry. SynQor's innovative packaging approach ensures survivability in the most hostile environments. Compatible with the industry standard format, these filters have high differential-mode and common-mode attenuation, low DC resistance, and a stabilizing bulk capacitor resistor. They follow conservative component derating guidelines and they are designed and manufactured to the highest standards.

MilCOTS™

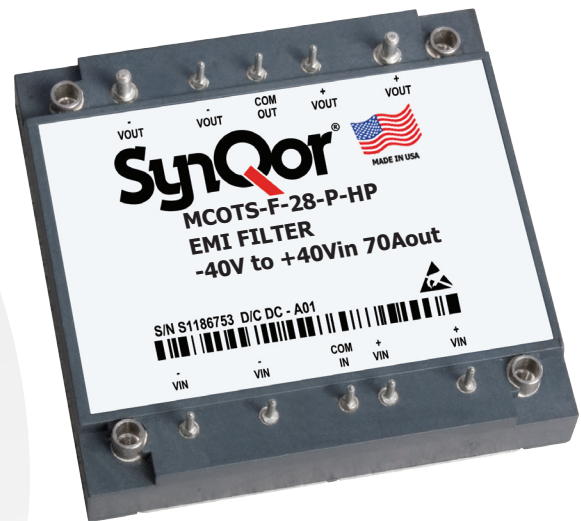

Designed and Manufactured in the USA

Operational Features

- 70A output current
- Very low DC resistance
- >150 dB differential-mode attenuation at 250kHz
- >20dB common-mode attenuation at 250kHz
- Stabilizing bulk capacitor and damping resistor included
- All capacitors are X7R multi-layer ceramic
- Designed to meet all MIL-STD 461 EMI requirements (D, E, F)

Mechanical Features

- Size: 2.49" x 2.39" x 0.51" (63.1 x 60.6 x 13.0 mm)
- Total Weight: 5.2 oz. (146 g)
- Flanged baseplate version available

Safety Features

- 2250V input/output to common-mode pins
- Certified 62368-1 requirement pending (see Standards and Qualifications page)

In-Line Manufacturing Process

- AS9100 and ISO 9001 Certified Facility
- Full component traceability

Screening Qualifications

- Qualified to MIL-STD-810
- Available with S-Grade or M-Grade screening
- Pre-cap inspection per IPC-610, Class III
- Temperature cycling per MIL-STD-883, Method 1010, Condition B, 10 cycles
- Burn-In at 100°C baseplate temperature
- Final visual inspection per MIL-STD-883, Method 2009



MCOTS-F-28-P-HP
Current: 70A

Fundamental Circuit Diagram

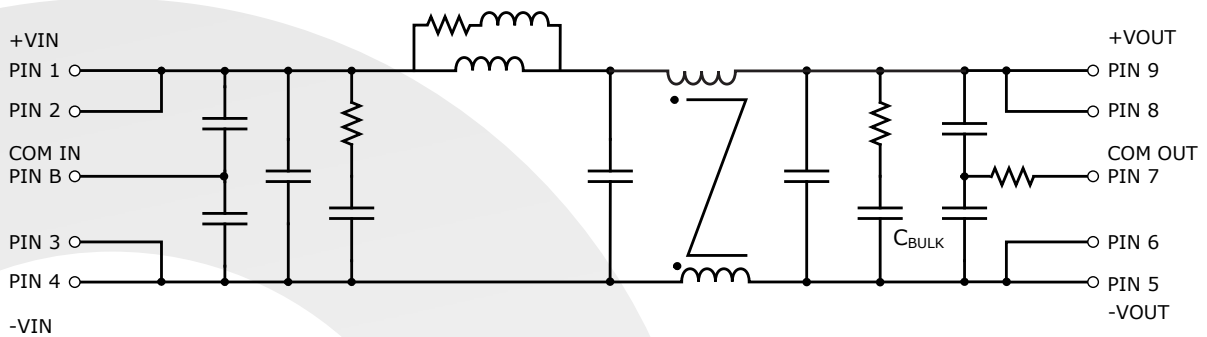

Typical Connection Diagram

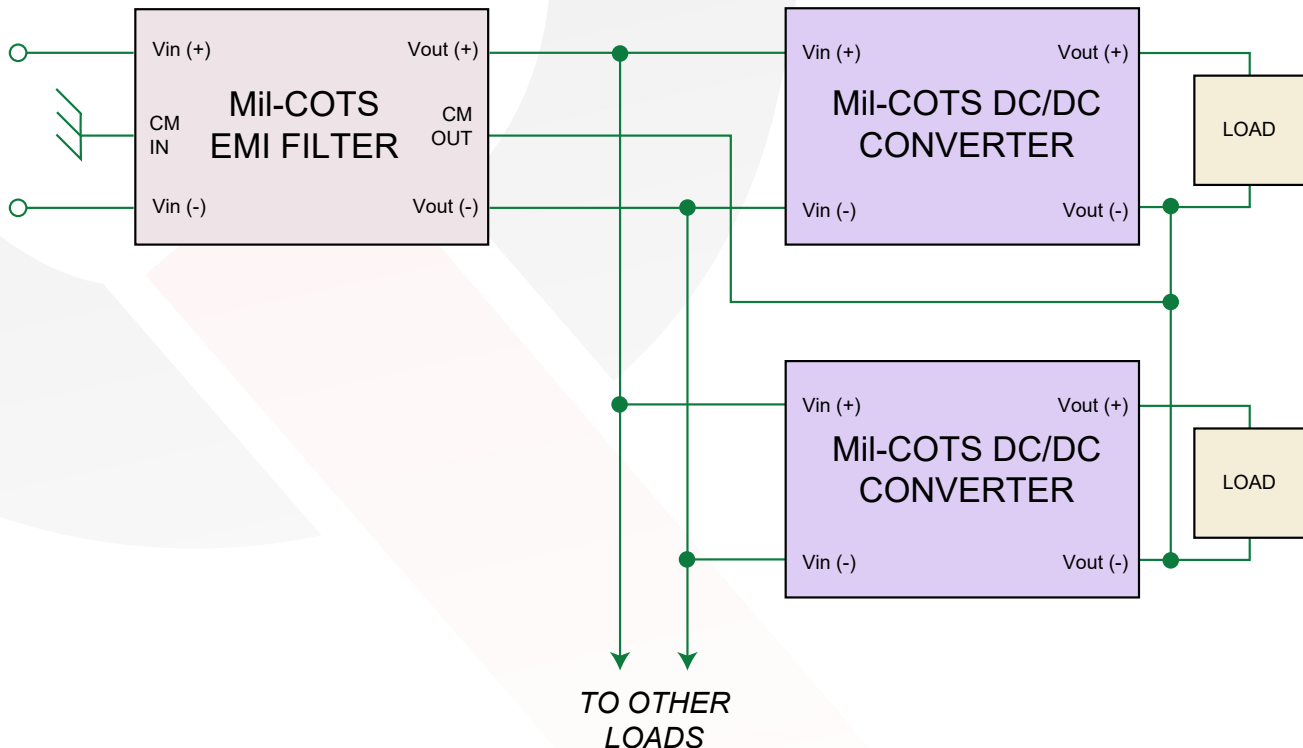



MCOTS-F-28-P-HP
Current: 70A

MCOTS-F-28-P-HP ELECTRICAL CHARACTERISTICS

|Vin| <=28V, |Iout| <= 70A unless otherwise specified.

Specifications subject to change without notice.

Parameter	Min.	Typ.	Max.	Units	Notes & Conditions
ABSOLUTE MAXIMUM RATINGS					
Input Voltage					
Continuous	-40		40	V	
Transient (≤ 1 s)	-50		50	V	
Isolation Voltage	-2250		2250	V	Input/Output to Common-mode pins
Output Current			70	A	
Operating Case Temperature	-55		100	°C	Baseplate Temperature
Storage Case Temperature	-65		135	°C	
RECOMMENDED OPERATION CONDITIONS					
Input Voltage					
Continuous	-40		40	V	
Transient (1 s, Rs* = 0 Ω)	-50		50	V	* Rs = Source Impedance
Output Power (continuous)	-70		70	A	
ELECTRICAL CHARACTERISTICS					
Output Voltage (continuous)	Vout = Vin - (Iin x Rdc)			V	
DC Resistance (Rdc)					Total
Tcase = 25°C		5.0		mΩ	
Tcase = 100°C			7.0	mΩ	
Power Dissipation					70A output current
Tcase = 25°C		25.0		W	
Tcase = 100°C			35.0	W	
Total Differential-Mode Capacitance		1.0		mF	Measured across input or output pins @100KHz
Total Common-Mode Capacitance		0.17		μF	Measured between any pin to case @100KHz
Bulk Capacitor		180		μF	
Damping Resistor		0.33		Ω	
Noise Attenuation					
Differential-Mode		150		dB	
Common-Mode		20		dB	
Isolation Resistance	100			MΩ	Any pin to common-mode pins
INPUT VOLTAGE SPIKE SUPPRESSION					
Output Voltage Deviation due to a Spike					
Input Voltage Spike (Centered on Vin)					
±250V, 100μs, Emax=15mJ	-5		5	ΔV	MIL-STD-1275D
±600V, 10μs, Rs* = 50Ω	-5		10	ΔV	RTCA/DO-160E/F/G
ISOLATION CHARACTERISTICS					
Isolation Voltage (any pin to common-mode pins)					
Continuous	-2000		2000	V	
Transient (≤ 100 μs)	-2250		2250	V	
Isolation Resistance (any pin to common-mode pins)	30			MΩ	
RELIABILITY CHARACTERISTICS					
Calculated MTBF (MIL-STD-217F2)					
GB @ Tcase = 70°C		113		MHrs.	
GM @ Tcase = 70°C		6.4		MHrs.	
Demonstrated MTBF				MHrs.	See our website for details
WEIGHT CHARACTERISTICS					
Device Weight		165.9		g	

* Rs = Source Impedance



Basic Operation and Features

This module is a multi-stage differential-mode and common-mode passive EMI filter designed to interface a power source with one or more Mil-COTS DC-DC converters (or other loads that create EMI). Each stage of this filter is well damped to avoid resonances and oscillations, and only X7R multi-layer ceramic capacitors are used. This Mil-COTS EMI filter includes a large bulk capacitor with a series damping resistor to correct for the unstabilizing effect of a converter's negative input resistance. A white paper discussing this negative input resistance and the need for corrective damping can be found on the SynQor website (see Input System Instability application note).

When used with SynQor's DC-DC converters, the Mil-COTS EMI filter is designed to pass all of the relevant MIL-STD-461C/D/E requirements to their most stringent limits. The MIL-STD-461 Compliance Matrix Table lists these requirements and describes the setup used to pass them. Figures 1-4 show results from selected conductive and radiated emissions tests when used with SynQor's MCOTS-C-28V-xx-HY% DC-DC converter.

A typical application would place the Mil-COTS filter close to the input of the DC-DC converter. The input-side common-mode pin would be connected to the chassis ground that is common with the system input line filter or other earthed point used for EMI measurement. The output-side common-mode pin would be connected to the output ground or plane of the power converters with as low inductance a path as possible. There are no connections to the metal baseplate, which may also be connected to the chassis ground if desired.

Do not connect the outputs of multiple Mil-COTS filters in parallel. Connecting filters in this manner may result in slightly unequal currents to flow in the positive and return paths of each filter. These unequal currents may cause the internal common-mode chokes to saturate and thus cause degraded common-mode rejection performance.

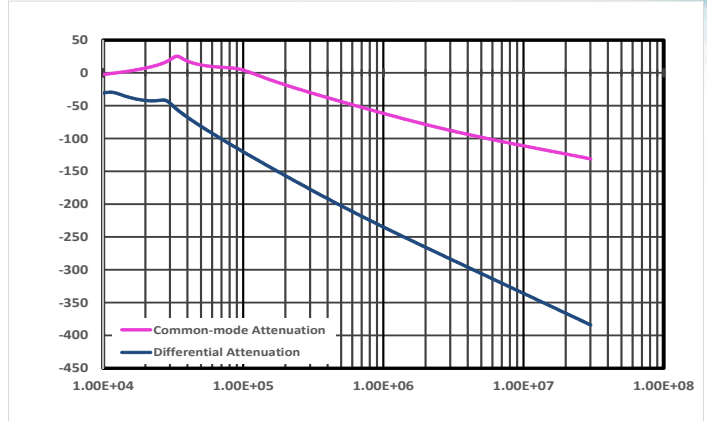

Figure A: Simulation of calculated common mode and differential mode attenuation. The curves plot the ratio of noise current in a 50Ω LISN sensing port connected to the noise output side of the filter (the power input side, pins 1 and 3) to the noise current on the input side (the power output side, pins 4 and 6). Refer to Figures B and C.

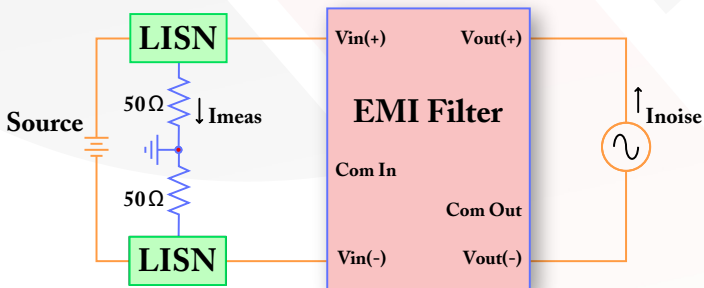

Figure B: Differential-Mode Current Attenuation, I_{meas} / I_{noise}

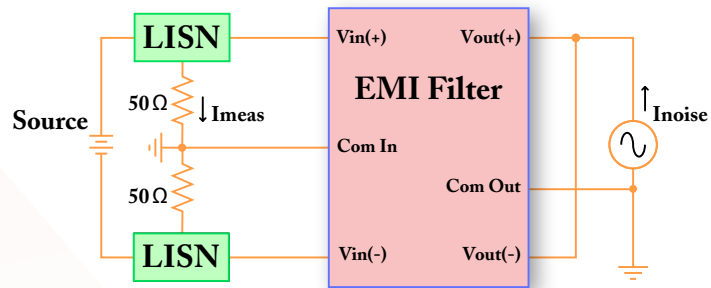

Figure C: Common-Mode Current Attenuation, I_{meas} / I_{noise}

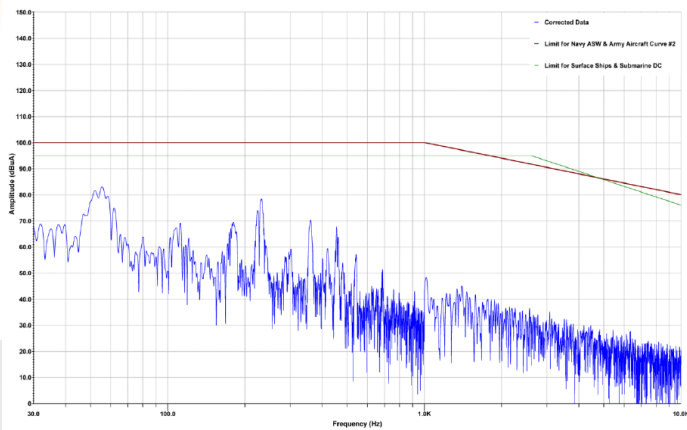

Figure 1: MIL-STD-461F Method CE101 Low Frequency Conducted Emissions.

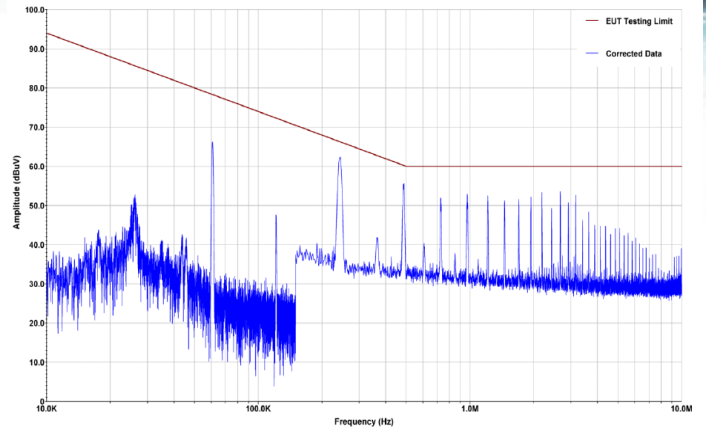

Figure 2: MIL-STD-461F Method CE102 High Frequency Conducted Emissions. Limit line (in red) is the 'Basic Curve'.

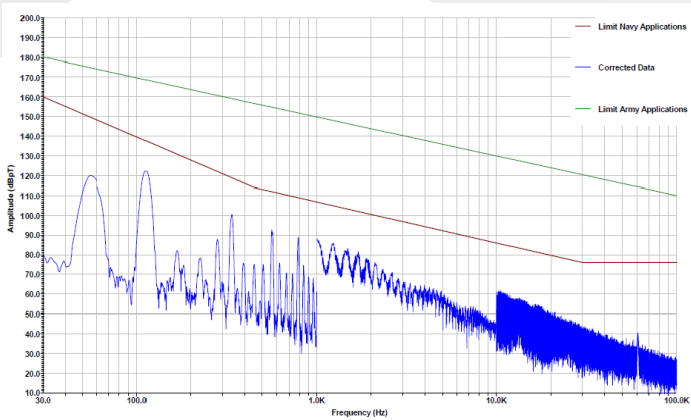

Figure 3: MIL-STD-461F Method RE101 Low Frequency Radiated Emissions.

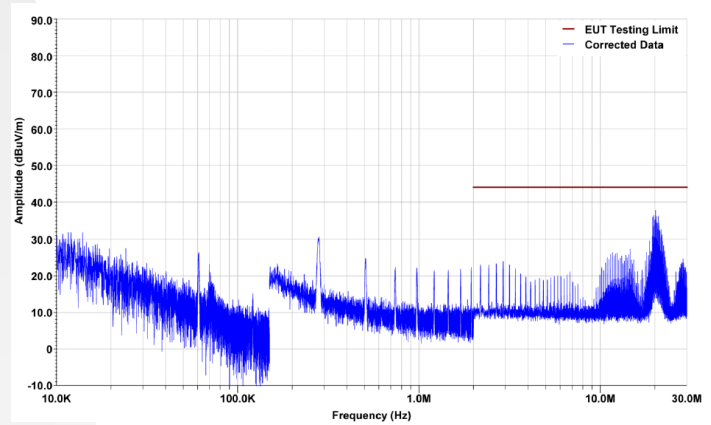
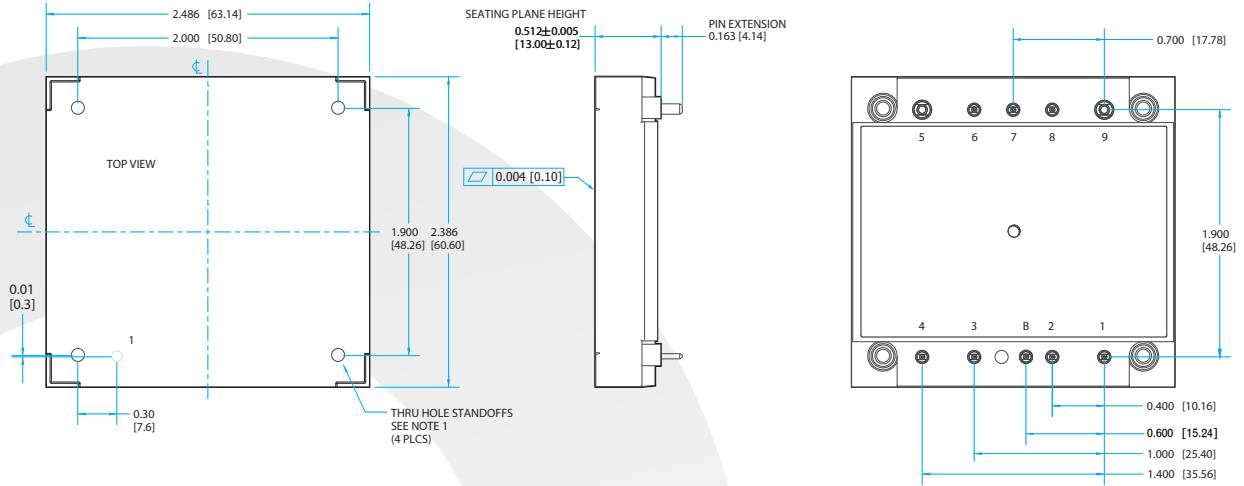

Figure 4: MIL-STD-461F Method RE102 High Frequency Radiated Emissions. Limit line (in red) is the 'Navy Fixed and Air Force'.

Encased Mechanical Diagram



NOTES

- Applied torque per M3 screw should not exceed 6in-lb (0.7 Nm).
For non-threaded standoffs, internal diameter 0.125" (3.18 mm)
- Baseplate flatness tolerance is 0.004" (.10mm) TIR for surface.
- Pins 1-4,6-8, and B are 0.040" (1.02mm) diameter, with 0.080" (2.03mm) diameter standoff shoulders.
- Pins 5 and 9 are 0.080" (2.03 mm) diameter with 0.125" (3.18 mm) diameter standoff shoulders.
- All Pins: Material – Copper Alloy; Finish – Matte Tin over Nickel plate
- Undimensioned components are shown for visual reference only.
- Weight: 5.2 oz. (146 g) typical
- Threaded or Non-Threaded options available
- All dimensions in inches (mm)
Tolerances: x.xx +/-0.02 in. (x.x +/-0.5mm)
x.xxx +/-0.010 in. (x.xx +/-0.25mm)
- Workmanship: Meets or exceeds IPC-A610 Class II

Pin	Label	Function
1	+VIN	Positive input voltage
2	+VIN	Positive input voltage
B	COM IN	Common mode input
3	-VIN	Negative input voltage
4	-VIN	Negative input voltage
5	-VOUT	Negative output voltage
6	-VOUT	Negative output voltage
7	COM OUT	Common mode output
8	+VOUT	Positive output voltage
9	+VOUT	Positive output voltage

Flanged Encased Mechanical Diagram

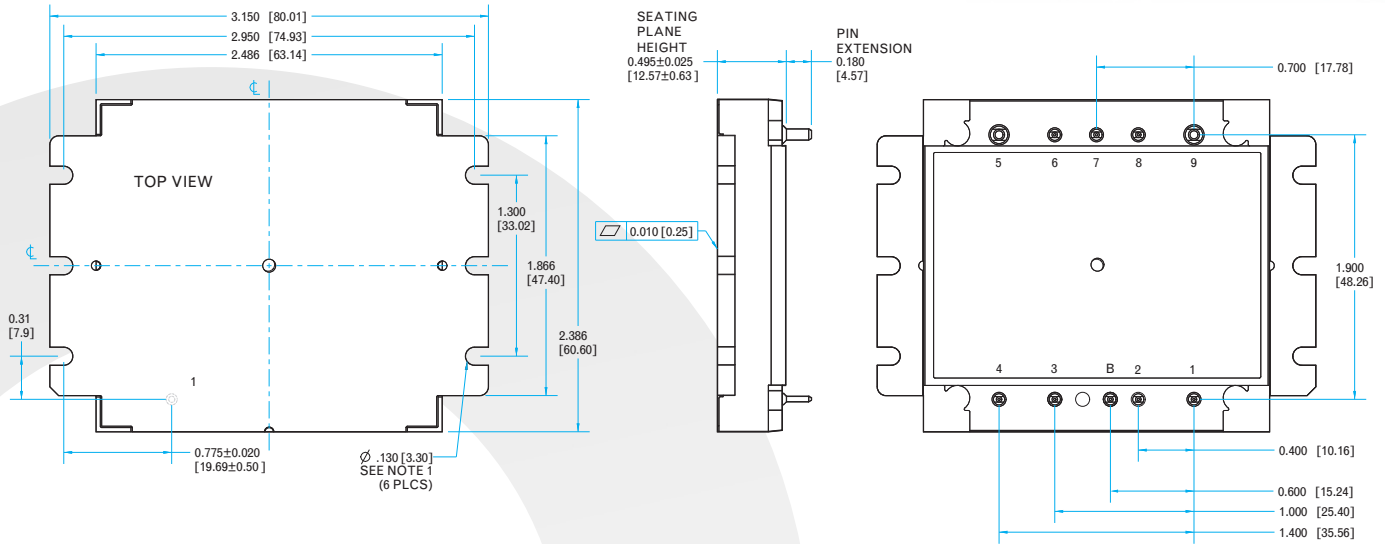

NOTES

- 1) Applied torque per M3 or 4-40 screw should not exceed 6in-lb (0.7 Nm).
- 2) Baseplate flatness tolerance is 0.010" (.2mm) TIR for surface.
- 3) Pins 1-4,6-8, and B are 0.040" (1.02mm) diameter, with 0.080" (2.03mm) diameter standoff shoulders.
- 4) Pins 5 and 9 are 0.080" (2.03 mm) diameter with 0.125" (3.18 mm) diameter standoff shoulders.
- 5) All Pins: Material – Copper Alloy; Finish – Matte Tin over Nickel plate
- 6) Undimensioned components are shown for visual reference only.
- 7) Weight: 5.4 oz. (152 g) typical
- 8) All dimensions in inches (mm)
Tolerances: x.xx +/-0.02 in. (x.x +/-0.5mm)
x.xxx +/-0.010 in. (x.xx +/-0.25mm)
- 9) Workmanship: Meets or exceeds IPC-A610 Class II

Pin	Label	Function
1	+VIN	Positive input voltage
2	+VIN	Positive input voltage
B	COM IN	Common mode input
3	-VIN	Negative input voltage
4	-VIN	Negative input voltage
5	-VOUT	Negative output voltage
6	-VOUT	Negative output voltage
7	COM OUT	Common mode output
8	+VOUT	Positive output voltage
9	+VOUT	Positive output voltage



MCOTS-F-28-P-HP
Current: 70A

Mil-COTS Qualification

Test Name	Details	# Tested (# Failed)	Consistent with MIL-STD-883F Method
Life Testing	Visual, mechanical and electrical testing before, during and after 1000 hour burn-in @ full load	15 (0)	Method 1005.8
Shock-Vibration	Visual, mechanical and electrical testing before, during and after shock and vibration tests	5 (0)	MIL-STD-202, Methods 201A & 213B
Humidity	+85 °C, 95% RH, 1000 hours, 2 minutes on / 6 hours off	8 (0)	Method 1004.7
Temperature Cycling	500 cycles of -55 °C to +100 °C (30 minute dwell at each temperature)	10 (0)	Method 1010.8, Condition A
Solderability	15 pins	15 (0)	Method 2003
DMT	-65 °C to +110 °C across full line and load specifications in 5 °C steps	7 (0)	
Altitude	70,000 feet (21 km), see Note	2 (0)	

Note: A conductive cooling design is generally needed for high altitude applications because of naturally poor convective cooling at rare atmospheres.

Mil-COTS Converter and Filter Screening

Screening	Process Description	S-Grade	M-Grade
Baseplate Operating Temperature		-55 °C to +100 °C	-55 °C to +100 °C
Storage Temperature		-65 °C to +135 °C	-65 °C to +135 °C
Pre-Cap Inspection	IPC-A-610, Class III	•	•
Temperature Cycling	MIL-STD-883F, Method 1010, Condition B, 10 Cycles		•
Burn-In	100 °C Baseplate	12 Hours	96 Hours
Final Electrical Test	100%	25 °C	-55 °C, +25 °C, +100 °C
Final Visual Inspection	MIL-STD-883F, Method 2009	•	•

STANDARDS COMPLIANCE

Parameter	Notes & Conditions
STANDARDS COMPLIANCE	Pending
UL 62368-1	Basic insulation
CAN/CSA-C22.2 No. 62368-1	
EN 62368-1	

Note: An external input fuse must always be used to meet these safety requirements. Contact SynQor for official safety certificates on new releases or download from the SynQor website.



MCOTS-F-28-P-HP
Current: 70A

Mil-COTS MIL-STD-810G Qualification Testing

MIL-STD-810G Test	Method	Description
Fungus	508.6	Table 508.6-I
Altitude	500.5 - Procedure I	Storage: 70,000 ft / 2 hr duration
	500.5 - Procedure II	Operating: 70,000 ft / 2 hr duration; Ambient Temperature
Rapid Decompression	500.5 - Procedure III	Storage: 8,000 ft to 40,000 ft
Acceleration	513.6 - Procedure II	Operating: 15 g
Salt Fog	509.5	Storage
High Temperature	501.5 - Procedure I	Storage: 135 °C / 3 hrs
	501.5 - Procedure II	Operating: 100 °C / 3 hrs
Low Temperature	502.5 - Procedure I	Storage: -65 °C / 4 hrs
	502.5 - Procedure II	Operating: -55 °C / 3 hrs
Temperature Shock	503.5 - Procedure I - C	Storage: -65 °C to 135 °C; 12 cycles
Rain	506.5 - Procedure I	Wind Blown Rain
Immersion	512.5 - Procedure I	Non-Operating
Humidity	507.5 - Procedure II	Aggravated cycle @ 95% RH (Figure 507.5-7 aggravated temp - humidity cycle, 15 cycles)
Random Vibration	514.6 - Procedure I	10 - 2000 Hz, PSD level of 1.5 g ² /Hz (54.6 g _{rms}), duration = 1 hr/axis
Shock	516.6 - Procedure I	20 g peak, 11 ms, Functional Shock (Operating no load) (saw tooth)
	516.6 - Procedure VI	Bench Handling Shock
Sinusoidal vibration	514.6 - Category 14	Rotary wing aircraft - helicopter, 4 hrs/axis, 20 g (sine sweep from 10 - 500 Hz)
Sand and Dust	510.5 - Procedure I	Blowing Dust
	510.5 - Procedure II	Blowing Sand

EMI

Military Standard 461 Compliance Matrix

This table shows the MIL-STD-461 requirements/limits that will be met* by the stand-alone setups indicated below:

Mil-Std-461	MIL-STD-461D/E/F	
	Requirement	Most Stringent Limit Listed
Conducted Emissions	CE101 CE102	Submarine Basic Curve
Conducted Susceptibility	CS101 CS106 CS114 CS115 CS116	Curve #2 461F Only Curve #5 Basic Waveform I _{max} = 10A
Radiated Emissions	RE101	Navy
	RE102†	Submarine Fixed Wing Internal, >25 meters Nose to Tail
Radiated Susceptibility	RS101 RS103	Army Aircraft External

* Susceptibility requirements/limits are considered to be met as long as transient deviations in the converter's output voltage remain within ±10% of its initial value.

† Met with metal screen shield covering the filter, converter, and resistive load.

‡ In almost every case the limit listed is the most stringent of the requirements. The one exception is CE03 - High Frequency Broadband Conducted Emissions, Converter with Passive Filter. In this case the filter and converter passed the A1 limit. The filter and converter pass the CE03 - Narrowband Conducted Emissions at the A5 limit level.

MCOTS	<ul style="list-style-type: none"> • MCOTS-F-28-P Filter • MCOTS-28-05S Converter • 120W Resistive load • Metal Chassis Plane • MCOTS-F-270-P Filter • MCOTS-270-05-QT Converter
--------------	--



Ordering Information

Example MCOTS-F-28-P-HP-N-S

Family	Product	Input Voltage	Filter Type	Package	Thermal Design	Screening Level
MCOTS	F: Filter	28: -40V to +40V 28E: -70V to +70V 48: -80V to +80V 270: -500V to +500V	P: Passive T: Transient	DM: Demi-Brick QT: Quarter-Brick Tera HT: Half-Brick Tera HP: Half-Brick Peta	N: Normal Threaded D: Normal Non-Threaded F: Flanged	S: S-Grade M: M-Grade

Not all combinations make valid part numbers, please contact SynQor for availability. See the Product Summary web page for more options.

Application Notes

A variety of application notes and technical white papers can be downloaded in pdf format from our website.

Contact SynQor for further information and to order:

Phone: 978-849-0600 Toll Free: 888-567-9596 Fax: 978-849-0602

E-mail: power@synqor.com Web: www.synqor.com

Address: 155 Swanson Road, Boxborough, MA 01719 USA

Warranty

SynQor offers a two (2) year limited warranty. Complete warranty information is listed on our website or is available upon request from SynQor.

PATENTS

SynQor holds numerous U.S. patents, one or more of which apply to most of its power conversion products. Any that apply to the product(s) listed in this document are identified by markings on the product(s) or on internal components of the product(s) in accordance with U.S. patent laws. SynQor's patents include the following:

6,927,987	7,050,309	7,765,687
7,787,261	8,149,597	8,644,027