



MPFC-115-270-QP
Power Factor Correction
Quarter-brick

Military Power Factor Correction Module

85-180Vrms Input Voltage	47 - 63Hz / 360 - 800Hz Input Frequency	270Vdc Output Voltage	350W Output Power	≥0.99 Power Factor	Up to 95% Full Load Efficiency
------------------------------------	---	---------------------------------	-----------------------------	------------------------------	--

The MPFCQor Power Factor Correction module is an essential building block of an AC-DC power supply. Used in conjunction with a hold-up capacitor, SynQor’s high efficiency DC-DC converters and SynQor’s AC line filter, the MPFCQor will draw a nearly perfect sinusoidal current (PF>0.99) from a single phase AC input. The module is supplied completely encased to provide protection from the harsh environments seen in many military and aerospace environments.

MPFCQor™



Designed and manufactured in the USA

Operational Features

- Input voltage range: 85-180Vrms
- Universal input frequency range: 47 - 63Hz / 360 - 800Hz
- 350W output power
- ≥0.99 Power Factor
- High efficiency: >95% (115Vrms)
- Internal inrush current limit
- Auxiliary 10V bias supply
- Compatible with SynQor’s MCOTS DC-DC converters and SynQor’s MCOTS AC line filters

Mechanical Features

- Industry standard quarter-brick pin-out
- Size: 1.54" x 2.39" x 0.50" (39.0 x 60.6 x 12.7 mm)
- Total weight: 3.07 oz. (87 g)
- Flanged baseplate version available

Protection Features

- Input current limit and auto-recovery short circuit protection
- Auto-recovery input under/over-voltage protection
- Auto-recovery output over-voltage protection
- Auto-recovery thermal shutdown

Safety Features

- Input/Output to baseplate isolation 2150Vdc
- CE Marked

Control Features

- PFC Enable
- Load Enable (also: Power Out Good signal)

Compliance Features

- Designed to meet these standards when used with SynQor MACF Filters & MCOTS DC-DC Converters.
- MIL-STD-461(A-F)
 - MIL-STD-1399
 - MIL-STD-704-2, -704-4, & -704-6* (see 704 app section)

Contents

Typical Application	2
Technical Specification	3
Technical Diagrams	5
Screening & Qualification Testing	7
Application Section	8
Encased Mechanical	14
Encased Mechanical with Flange	15
Ordering Information	16



MPFC-115-270-QP
Input:85-180Vrms
Output:270Vdc
Power:350W

Typical Application of the MPFC Module

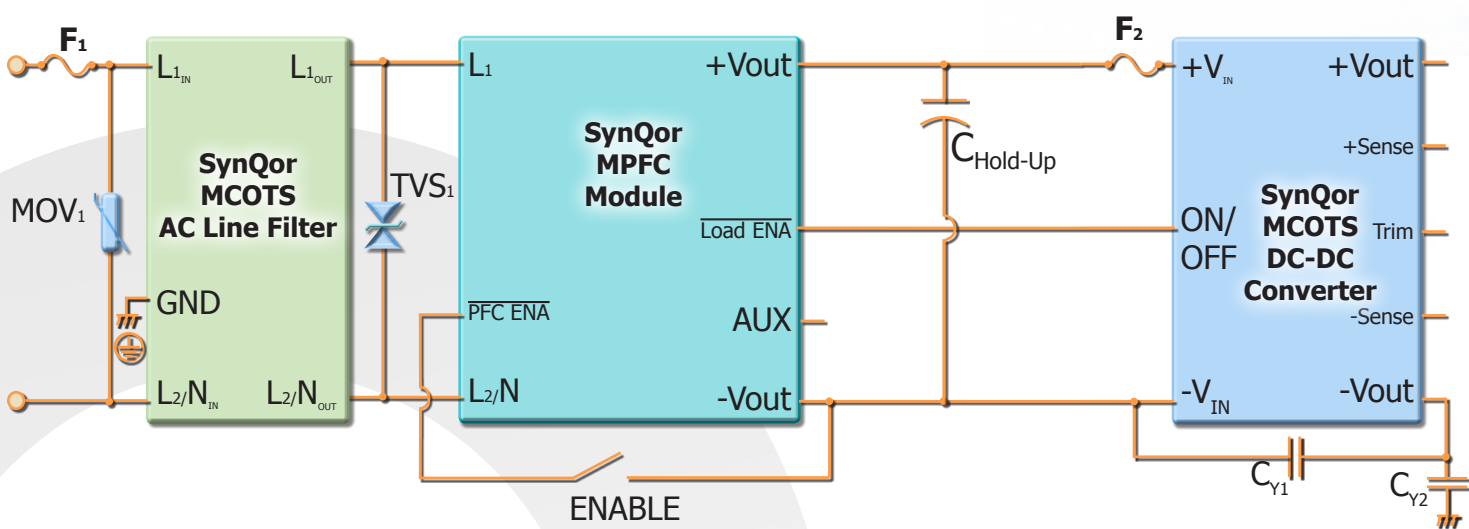

- F_1 : 5A / 250V Fuse
- MOV_1, TVS_1 : Must prevent peak voltage from exceeding 450V during all transients.
- F_2 : Use fuse recommended in converter specification
- $C_{Hold-Up}$: 100 - 1,000 μF (Dependent on Power Level and Line Frequency)
- C_{Y1-Y2} : See "EMI Considerations" in application notes

Example Parts:

- F_1 : 250VAC, 5A; Littelfuse 0216005.MXEP
- MOV_1 : 210VAC, 80J; EPCOS S14K210E2
- TVS_1 : 300V, 3J; two VISHAY 1.5KE150CA devices connected in series
- $C_{Hold-Up}$: Two 315V, 330 μF ; Nichicon UVZ 2F331MRD in parallel (-40C)
 Four 200V, 720 μF ; Cornell Dubilier MLSG721M200EB0C in **series & parallel** connection (-55C)
- C_{Y1} : 3.3nF, 500VAC; Vishay VY1332M59Y5UQ6TV0
- C_{Y2} : 10nF, 300VAC; Vishay VY2103M63Y5US63V7

Figure A: Typical Application of the MPFCQor module to create an AC-DC Power Supply



MPFC-115-270-QP
Input:85-180Vrms
Output:270Vdc
Power:350W

Technical Specification

MPFC-115-270-QP Electrical Characteristics

Operating conditions of 115Vrms, 60Hz input, 350W output, 400uF bulk capacitance, and baseplate temperature = 25°C unless otherwise noted; full operating baseplate temperature range is -55 °C to +100 °C with appropriate power derating. Specifications subject to change without notice.

Parameter	Min.	Typ.	Max.	Units	Notes & Conditions
ABSOLUTE MAXIMUM RATINGS					
Input Voltage (L1 to L2/N)			575		
Isolation Voltage (Input / Output to Baseplate)			2150	Vdc	
Operating Temperature	-55		100	°C	Baseplate temperature
Storage Temperature	-65		135	°C	
Voltage at LOAD ENA pins	-0.3		16	V	Relative to Vout- pin
Current drawn from AUX pin	0		10	mADC	
Voltage at PFC enable pin	-2		575	V	Relative to Vout- pin
INPUT CHARACTERISTICS (L1 to L2/N)					
Operating Input Voltage Range					
AC Input Continuous	85		180	Vrms	See Figure 10 for power derating vs. Vin, f
AC Input 100ms Transient	40		180	Vrms	Available output power reduced when <85 Vrms
Input Under-Voltage Lockout		30		Vrms	>1s Duration
Operating Input Frequency	47		63	Hz	50/60Hz range
	360		800	Hz	400Hz range
Power Factor of AC Input Current		0.99			50/60Hz, min 200W output
		0.97			400Hz, min 200W output
Total Harmonic Distortion of AC Input Current		3		%	
Inrush of AC Input Current					When used with SynQor MACF AC line filter
50/60Hz			10	Apk	
400Hz			20	Apk	
Enabled AC Input Current (no load)		50	80	mArms	
Disabled AC Input Current		30	50	mArms	
Maximum Input Power			385	W	
Maximum Input Current			4.8	Arms	85 VAC in
OUTPUT CHARACTERISTICS					
Output Voltage Set Point	265	270	275	Vdc	
Output Voltage Regulation					
Over Line			±0.3	%	Vin <160Vrms
Over Load			±2	%	
Over Temperature			±1.5	%	
Total Output Voltage Range	260	270	275	V	
Output Voltage Ripple and Noise					60Hz, see Note 1
Peak-to-Peak			10	V	With 400uF hold-up capacitor
RMS			4	V	
Operating Output Current Range	0		1.3	A	
Output Over-Voltage Threshold	320		330	V	See application section
Output (Hold-up) Capacitance	100		1,000	µF	See Note 2
Output Common-Mode Capacitance			20	nF	See "EMI Considerations" in application notes
Efficiency					
50% Load		94		%	See Figure 1 for efficiency curve
100% Load		95		%	See Figure 1 for efficiency curve

Note 1: 400 µF electrolytic hold-up capacitor having a typical ESR of 0.5Ω. Ripple amplitude dependent on capacitance and ESR of hold-up capacitor.
 Note 2: The MPFCQor is able to operate with a minimum of 100uF of hold-up capacitance, but Synqor recommends at least 660uF if the power system will be required to conform to lightning surge standards. This is because the PFCQor relies on the hold-up capacitor to absorb the energy from a lightning surge.



MPFC-115-270-QP
Input:85-180Vrms
Output:270Vdc
Power:350W

Technical Specification

MPFC-115-270-QP Electrical Characteristics (continued)

Operating conditions of 115Vrms, 60Hz input, 350W output, 400uF bulk capacitance, and baseplate temperature = 25°C unless otherwise noted; full operating baseplate temperature range is -55 °C to +100 °C with appropriate power derating. Specifications subject to change without notice.

Parameter	Min.	Typ.	Max.	Units	Notes & Conditions
DYNAMIC CHARACTERISTICS					
Turn-On Transient					
Start-up Inhibit Time		10		ms	
Turn-On Time		2		s	
Output Voltage Overshoot		0	2	%	
ISOLATION CHARACTERISTICS (Input/output to baseplate)					
Isolation Voltage			2150	V	
Isolation Resistance		100		MΩ	
Isolation Capacitance		100		pF	
TEMPERATURE LIMITS FOR POWER DERATING CURVES					
Semiconductor Junction Temperature			125	°C	
Board Temperature			125	°C	
Transformer Temperature			125	°C	
Maximum Baseplate Temperature, Tb			100	°C	
FEATURE CHARACTERISTICS					
Output Precharge					
Output Current		50		mA	
Output Short-Circuit Withstand			indefinite	s	
Free Running Switching Frequency		250		kHz	Each of 2 interleaved phases
PFC Enable (PFC ENA)				V	
Off-State Voltage	2			V	
On-State Voltage			0.8	V	
Internal Pull-Up Voltage		5		V	
Internal Pull-Up Resistance		10		kΩ	
Load Enable					
Pull-down resistance			20	Ω	Open collector
Output Voltage for Load Enable (Good) State					
Rising / Startup		250		V	
Falling / Shutdown		100		V	
Over-Temperature Trip Point		130		°C	At internal PCB
Auxiliary Bias Supply					
Voltage Range (≤3 mA Load)	7		12	V	
Maximum Source Current			10	mA DC	
Equivalent Series Resistance		1		kΩ	
RELIABILITY CHARACTERISTICS					
Calculated MTBF (MIL-217) MIL-HDBK-217F		1260		kHrs	Ground Benign, Tb = 70°C
Calculated MTBF (MIL-217) MIL-HDBK-217F		150		kHrs	Ground Mobile, Tb = 70°C



MPFC-115-270-QP
Input:85-180Vrms
Output:270Vdc
Power:350W

Technical Diagrams

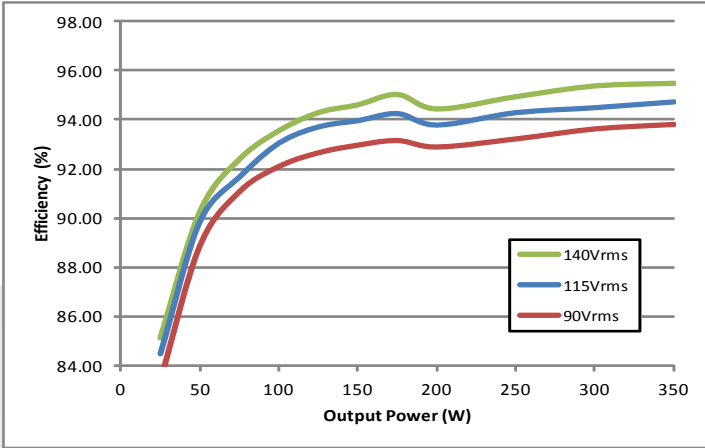

Figure 1: Efficiency at nominal output voltage vs. load power for 90Vrms, 115Vrms and 140Vrms (60Hz) input voltage at $T_b = 25^\circ\text{C}$.

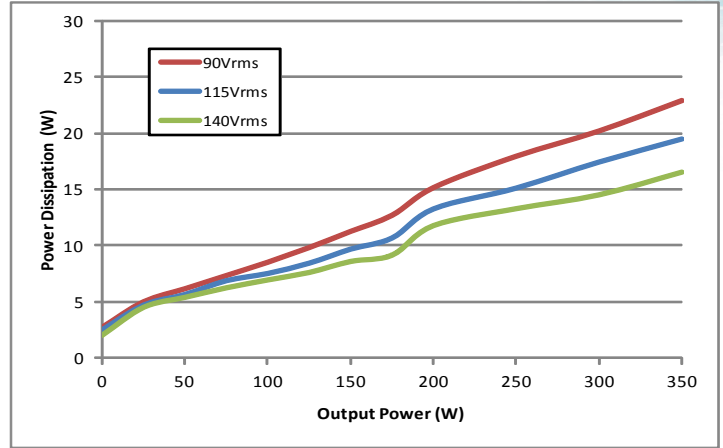

Figure 2: Power dissipation at nominal output voltage vs. load power for 90Vrms, 115Vrms and 140Vrms (60Hz) input voltage at $T_b = 25^\circ\text{C}$.

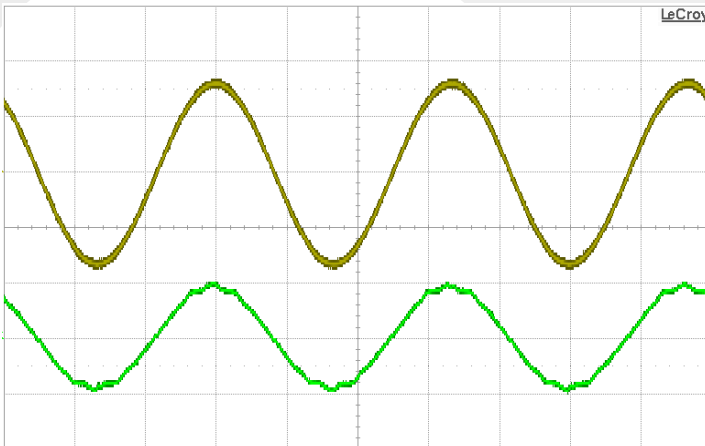

Figure 3: Typical Input Voltage and Current waveforms at full rated power (115Vrms, 60Hz) Top: V_{in} (100V/div), Bottom: I_{in} (5A/div), Timebase: (5ms/div).

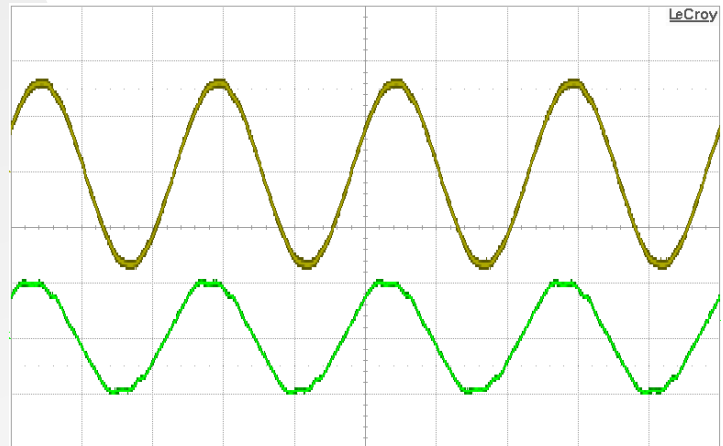

Figure 4: Typical Input Voltage and Current waveforms at full rated power (115Vrms, 400Hz). Top: V_{in} (100V/div), Bottom: I_{in} (5A/div), Timebase: (1ms/div).

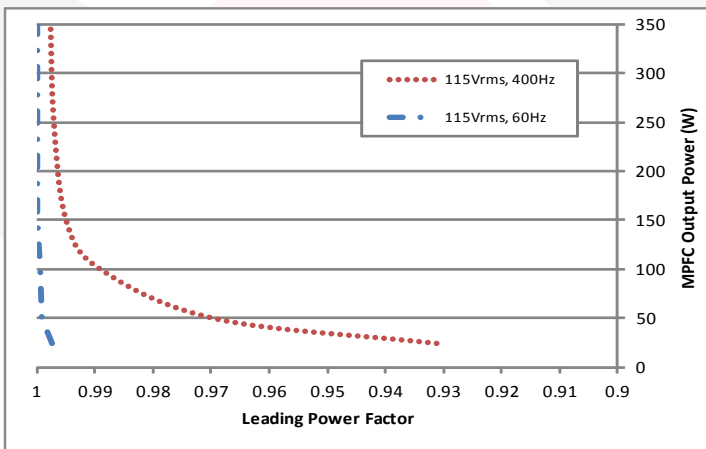

Figure 5: Output power vs. leading power factor, MPFC module only

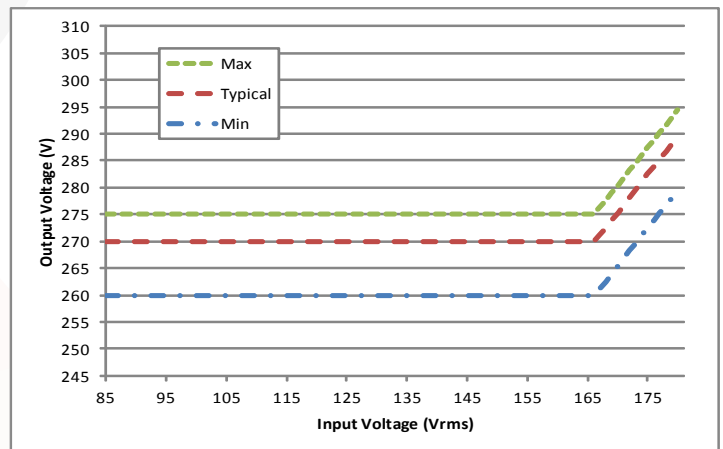

Figure 6: DC output voltage range vs. input voltage



MPFC-115-270-QP
Input:85-180Vrms
Output:270Vdc
Power:350W

Technical Specification

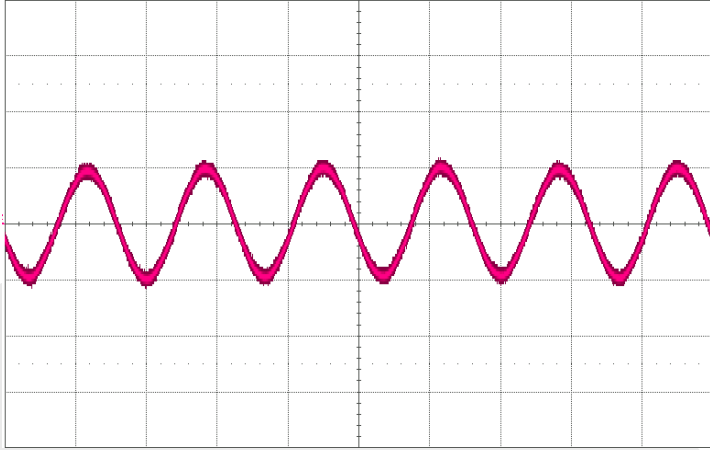

Figure 7: Output voltage ripple with 400µF Hold-up capacitor at full rated power (115VAC, 60Hz) Vout (5V/div), Timebase: (5ms/div)

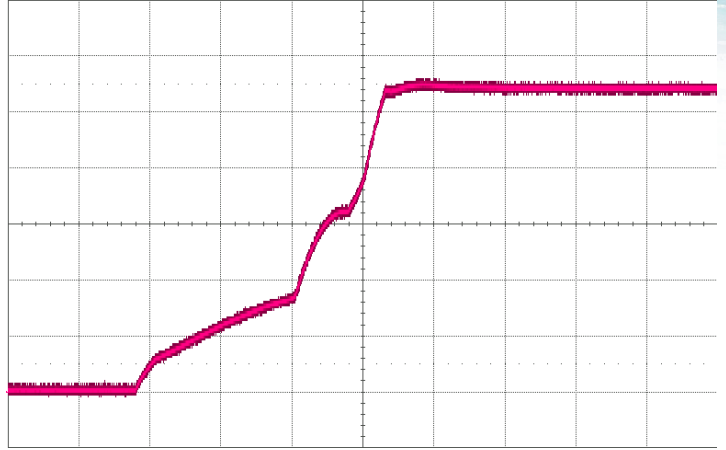

Figure 8: Output voltage startup waveform with 400µF hold-up capacitor, no load (115VAC, 60Hz), (50V/div), Timebase: (500ms/div)

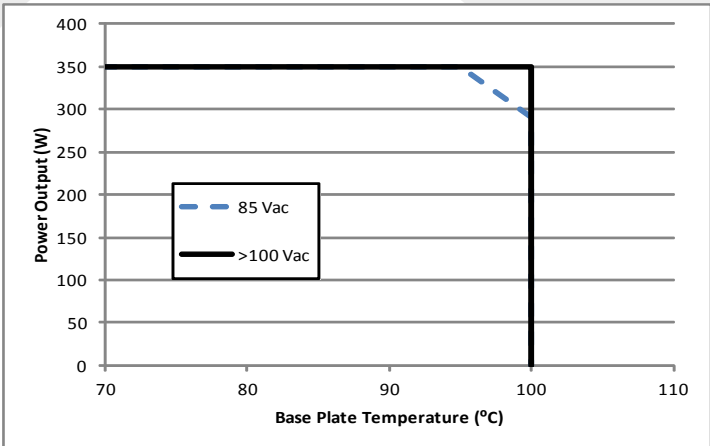

Figure 9: Output power vs. baseplate temperature derating curve

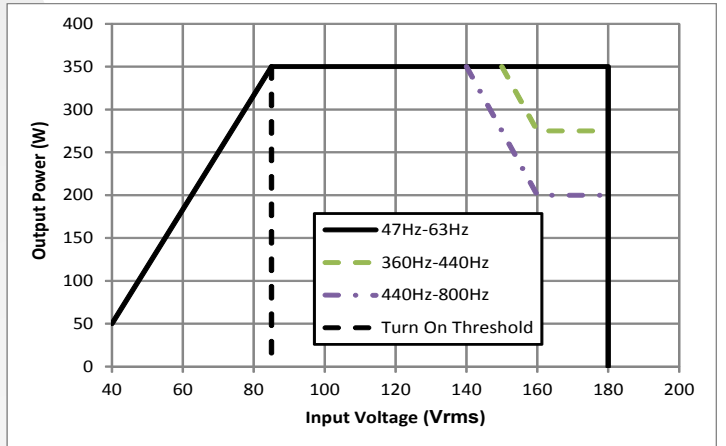

Figure 10: Continuous output power vs. input voltage, output turn-on threshold is 85Vrms



MPFC-115-270-QP
Input:85-180Vrms
Output:270Vdc
Power:350W

Screening & Qualification Testing

Mil-COTS Qualification

Test Name	Details	# Tested (# Failed)	Consistent with MIL-STD-883F Method
Life Testing	Visual, mechanical and electrical testing before, during and after 1000 hour burn-in @ full load	15 (0)	Method 1005.8
Shock-Vibration	Visual, mechanical and electrical testing before, during and after shock and vibration tests	5 (0)	MIL-STD-202, Methods 201A & 213B
Humidity	+85 °C, 95% RH, 1000 hours, 2 minutes on / 6 hours off	8 (0)	Method 1004.7
Temperature Cycling	500 cycles of -55 °C to +100 °C (30 minute dwell at each temperature)	10 (0)	Method 1010.8, Condition A
Solderability	15 pins	15 (0)	Method 2003
DMT	-65 °C to +110 °C across full line and load specifications in 5 °C steps	7 (0)	
Altitude	70,000 feet (21 km), see Note	2 (0)	

Note: A conductive cooling design is generally needed for high altitude applications because of naturally poor convective cooling at rare atmospheres.

Mil-COTS Converter and Filter Screening

Screening	Process Description	S-Grade	M-Grade
Baseplate Operating Temperature		-55 °C to +100 °C	-55 °C to +100 °C
Storage Temperature		-65 °C to +135 °C	-65 °C to +135 °C
Pre-Cap Inspection	IPC-A-610, Class III	•	•
Temperature Cycling	MIL-STD-883F, Method 1010, Condition B, 10 Cycles		•
Burn-In	100 °C Baseplate	12 Hours	96 Hours
Final Electrical Test	100%	25 °C	-55 °C, +25 °C, +100 °C
Final Visual Inspection	MIL-STD-883F, Method 2009	•	•

Mil-COTS MIL-STD-810G Qualification Testing

MIL-STD-810G Test	Method	Description
Fungus	508.6	Table 508.6-I
Altitude	500.5 - Procedure I	Storage: 70,000 ft / 2 hr duration
	500.5 - Procedure II	Operating: 70,000 ft / 2 hr duration; Ambient Temperature
Rapid Decompression	500.5 - Procedure III	Storage: 8,000 ft to 40,000 ft
Acceleration	513.6 - Procedure II	Operating: 15 g
Salt Fog	509.5	Storage
High Temperature	501.5 - Procedure I	Storage: 135 °C / 3 hrs
	501.5 - Procedure II	Operating: 100 °C / 3 hrs
Low Temperature	502.5 - Procedure I	Storage: -65 °C / 4 hrs
	502.5 - Procedure II	Operating: -55 °C / 3 hrs
Temperature Shock	503.5 - Procedure I - C	Storage: -65 °C to 135 °C; 12 cycles
Rain	506.5 - Procedure I	Wind Blown Rain
Immersion	512.5 - Procedure I	Non-Operating
Humidity	507.5 - Procedure II	Aggravated cycle @ 95% RH (Figure 507.5-7 aggravated temp - humidity cycle, 15 cycles)
Random Vibration	514.6 - Procedure I	10 - 2000 Hz, PSD level of 1.5 g ² /Hz (54.6 g _{rms}), duration = 1 hr/axis
Shock	516.6 - Procedure I	20 g peak, 11 ms, Functional Shock (Operating no load) (saw tooth)
	516.6 - Procedure VI	Bench Handling Shock
Sinusoidal vibration	514.6 - Category 14	Rotary wing aircraft - helicopter, 4 hrs/axis, 20 g (sine sweep from 10 - 500 Hz)
Sand and Dust	510.5 - Procedure I	Blowing Dust
	510.5 - Procedure II	Blowing Sand

Application Section

Basic Operation & Features

The MPFCQor power factor correction module is an essential building block of an overall high power AC-DC power supply. As shown in Fig. A, a typical power supply would be comprised of a SynQor MCOTS AC Line Filter, a SynQor MPFCQor module, an energy storage hold-up capacitor and one or more SynQor MCOTS DC-DC converters, depending on how many output voltages are required. Fuses are needed in various places to meet safety requirements.

The primary purpose of the MPFCQor is to shape the input current that is drawn from a single-phase sinusoidal AC source into a nearly perfect sinusoidal waveform so that the AC-DC power supply will present a very high power factor load ($PF > 0.99$) to this source. In doing this wave-shaping, the MPFCQor ensures that the harmonic components of the AC current waveform are below the levels called for in MIL-STD-1399.

The MPFCQor accomplishes its wave-shaping task by first rectifying the filtered AC source voltage, and then processing the input power through a non-isolated, high-efficiency, high-frequency “boost converter” that both gives the input AC current its sinusoidal shape and provides a regulated DC voltage across the hold-up capacitor.

The hold-up capacitor handles the cyclic imbalance between the flow of energy drawn from the AC source and the flow of energy delivered to the DC-DC converters. This energy imbalance has a cyclic frequency twice that of the AC source voltage (e.g. 120Hz for a 60Hz input). This relatively low frequency makes the hold-up capacitor relatively large. Another purpose of the hold-up capacitor is to be a source of energy so that the DC-DC converters can continue to deliver load power during a temporary brownout or dropout of the AC source. A typical power supply will have sufficient hold-up capacitor to give a “hold-up time” in the 20ms range, but longer times can be achieved with yet more hold-up capacitance.

Besides shaping the AC current waveform, the MPFCQor performs several other important functions. At start-up it controls the level of inrush current drawn from the AC source to charge the hold-up capacitor. It limits the DC current that can be drawn from its output and it will shut-down if a short circuit appears across the output. It will also shut-down if the AC input voltage is out of its range (either too high or too low) for too long, or if the temperature of the module is too high.

In addition, the MPFCQor has input and output control signals that include PFC_ENABLE, and LOAD_ENABLE, (which doubles as a POWER_OUT_GOOD signal). Both signals are described in more detail below. There is also an auxiliary bias supply that can be used to power a low power control circuit at the output of the MPFCQor.

StartUp Sequence

When the AC source voltage is first applied, regardless of whether the MPFCQor is enabled or disabled through its PFC_ENABLE pin, the MPFCQor will pre-charge the output hold-up capacitor with a current limited to approximately 50mA. This pre-charging continues until the output voltage is within approximately 10V of the peak voltage of the AC source. If, at this time, the PFC_ENABLE input is logically high, and the MPFCQor is therefore disabled, the MPFCQor will remain in this pre-charged state indefinitely.

NOTE: During both this pre-charging time and for whatever time afterwards that the MPFCQor remains disabled it is essential that all the load converters connected to the output of the MPFCQor be disabled so that the total load current seen by the MPFCQor is only a small fraction of the 50mA charging current. To help facilitate this requirement, the MPFCQor’s LOAD_ENABLE output can be used to disable the load converters.

When the PFC_ENABLE input pin is pulled low, and after the pre-charging is completed if it is not already, the boost converter within the MPFCQor will start operating and the MPFCQor’s output voltage will be increased to its nominal regulated value.

After this regulated voltage level is achieved, the MPFCQor will provide a logical low signal on its LOAD_ENABLE output pin. This signal should be used to enable the load converters so that they can begin to draw power from the MPFCQor.

If the PFC_ENABLE input is de-asserted (pulled high or allowed to float), the boost converter in the MPFCQor will shut down and the LOAD_ENABLE output pin will return to a logic high. This will then disable the load converters.

NOTE: The voltage across the hold-up capacitor will remain in a charged state after the MPFCQor is disabled as long as the AC source voltage is present.



MPFC-115-270-QP
Input:85-180Vrms
Output:270Vdc
Power:350W

Application Section

Brownout/Dropout Sequence

If the AC source voltage is present but it is below its continuous minimum input voltage limit, the MPFCQor will still draw whatever power it can (within its current limits) from the AC source. This power may not be enough for the total load power, in which case the hold-up capacitor will provide the balance of the power. The voltage across the hold-up capacitor will therefore drop as it discharges.

If the AC source voltage drops below its specified transient minimum input voltage limit, the MPFCQor's boost converter will shut down and no longer deliver power to the output. Under this condition, all of the load power will be drawn from the hold-up capacitor.

If and when the voltage across the hold-up capacitor drops below its specified minimum limit, the `LOAD_ENABLE` output will be de-asserted to a logic high. Besides disabling the load converters, this condition will cause the MPFCQor to return to the beginning of the startup sequence described above.

NOTE: Regardless of what happens to the MPFCQor's output voltage under a brownout or dropout condition, if the AC source voltage drops below its rated under-voltage value for 1 second or more, the MPFCQor will shut down.

If, however, the voltage across the hold-up capacitor does not drop below its specified minimum limit before the AC source voltage returns to within its continuous operating range (and it hasn't been absent for more than 1 second), the MPFCQor will automatically re-establish its power flow. The hold-up capacitor will be recharged immediately to the peak of the AC source voltage (if it has fallen below this value) and to its nominal regulated voltage level within a few cycles of the AC source waveform.

NOTE: During the first phase where the hold-up capacitor is recharged (if this phase exists) there will be an inrush current drawn from the AC source that depends on the details of how quickly the AC source voltage returns to its normal operating condition.

Control Features

Auxiliary Power Supply (AUX) (Pin 5):

The circuit shown below is an effective model for the AUX bias power supply:

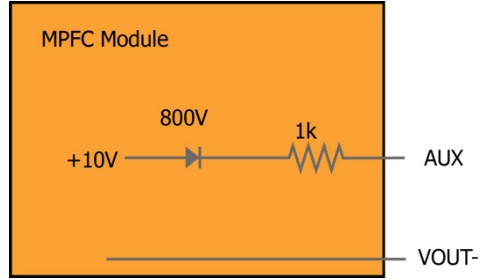

The purpose of the AUX power supply is to provide a low level of power to control circuitry at the output of the MPFCQor, such as the circuits shown earlier in this section.

The AUX power supply is present and regulated whenever the MPFCQor's output voltage is greater than approximately 75V. The AUX bias power supply is unspecified when MPFCQor's output voltage is less than about 75V (it may, for instance, come and go as the output voltage rises on its way to 75V).

PFC_ENABLE (Pin 2):

The MPFCQor uses the following circuit for this input logic signal:

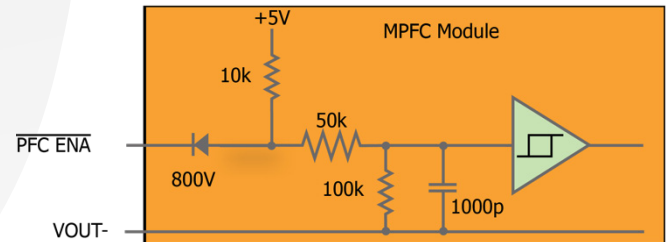

- If this input is floating or tied high the MPFCQor's boost converter is disabled and the `LOAD_ENABLE` output signal is de-asserted high.
- If this input is pulled low the MPFCQor's boost is enabled after the pre-charger has charged the voltage across the hold-up capacitor to within approximately 10 volts of the peak of the AC source voltage.



MPFC-115-270-QP
Input:85-180Vrms
Output:270Vdc
Power:350W

Application Section

LOAD_ENABLE

(also: POWER OUT GOOD signal) (Pin 6):

The MPFCQor uses the following circuit for this output logic signal:

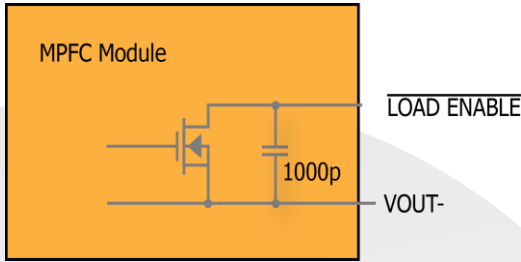

- When the **LOAD_ENABLE** pin is internally pulled LOW the load converters are permitted to draw power from the MPFCQor's output.
- When the **LOAD_ENABLE** floats all load converters should be disabled.
- The **LOAD_ENABLE** can be tied directly to the **ON/OFF** control pins of SynQor's DC-DC converters as shown in Figure A.
- For loads that are not SynQor DC-DC converters and that do not otherwise have a way to be enabled/disabled, an external power MOSFET can be used to connect and disconnect these loads from the MPFCQor's output based on the status of the **LOAD_ENABLE** signal, as shown below.

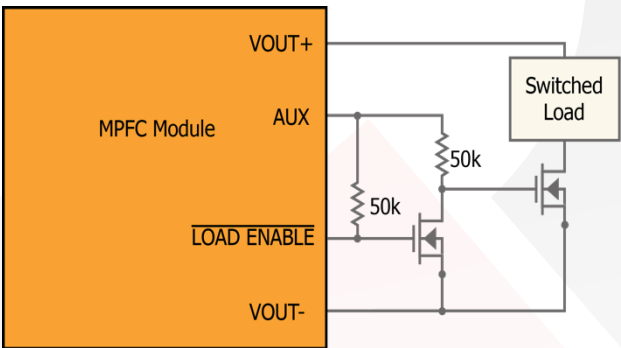

- For high-side or remotely switched loads, an optoisolator can be employed as shown below.

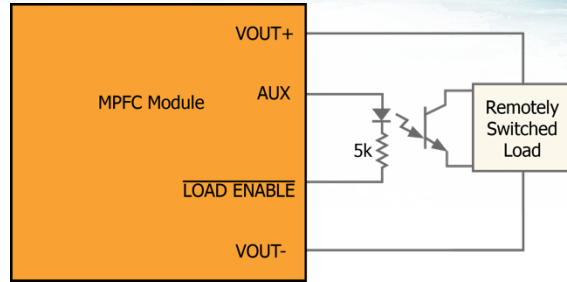

Protection Features

Input Over- and Under-Voltage:

If the AC source voltage exceeds the maximum peak voltage rating defined in the electrical specifications, the MPFCQor will shut down. However, under this condition the MPFCQor's pre-charge circuit will continue to deliver 50mA of current to the output whenever the AC source voltage is higher than the DC output voltage. Care must be taken to ensure this condition does not allow the output voltage to rise high enough to damage the MPFCQor or the load converters.

If a brownout or dropout of the AC source voltage occurs, and if it lasts long enough for the MPFCQor's output voltage to drop below its specified minimum limit, the MPFCQor will shut down. Furthermore, regardless of what happens to the MPFCQor's output voltage, if the AC source voltage drops below its rated under-voltage value for 1 second or more, the MPFCQor will shut down.

After any shutdown, the MPFCQor will automatically return to the beginning of the startup sequence described above.

Output Over-Voltage:

If the output voltage exceeds its specified maximum limit, the MPFC will remain active, but will stop delivering power through its main boost stage until the output voltage falls below the over-voltage threshold.

Under this condition, the MPFCQor's pre-charge circuit will continue to deliver 50mA of current to the output whenever the AC source voltage is higher than the dc output voltage. Care must be taken to ensure this condition does not allow the output voltage to rise high enough to damage the MPFCQor or the load converters.



MPFC-115-270-QP
Input:85-180Vrms
Output:270Vdc
Power:350W

Application Section

Output Current Limit and Short-Circuit Shutdown:

If the MPFCQor's output is overloaded such that its output current limit becomes activated, the output voltage will fall as the excess load current discharges the hold-up capacitor. The MPFCQor will continue to deliver power into this overload condition for 100 ms, after which the unit will shut down and automatically return to the beginning of the startup sequence described above. If at any point the output voltage falls below the peak of the AC source voltage, the MPFCQor will immediately shut down and return to the startup sequence.

Over Temperature:

If the internal temperature of the MPFCQor reaches 130°C, the MPFCQor will turn off its boost converter. The **LOAD_ENABLE** output will simultaneously be deasserted high. When the internal temperature falls below 110°C, the MPFCQor will return to the beginning of the startup sequence described above.

Energy Storage Hold-Up Capacitor

The hold-up capacitor performs two functions:

- It handles the cyclic imbalance between the flow of energy drawn from the AC source and the flow of energy delivered to the DC-DC converters. In doing so, the voltage across the hold-up capacitor has a ripple at a frequency twice that of the AC source voltage (e.g. 120Hz for a 60Hz input). The larger the hold-up capacitor, or the higher the frequency of the AC source, the smaller this ripple will be.
- It provides a source of energy so that the DC-DC converters can continue to deliver load power during a temporary brownout or dropout of the AC source. The larger the hold-up capacitor the longer it can provide this energy. Often it will be made large enough to allow the load to be gracefully shutdown after the AC source has been outside of its normal range for a set amount of time. A typical "hold-up time" would be in the 20 ms range for a 50/60 Hz system.

The total energy stored in a hold-up capacitor having capacitance C at any given voltage V is:

$$E = \frac{1}{2}CV^2$$

The amount of energy, ΔE , which can be drawn from this capacitor depends on the capacitor's starting voltage, V_s , and its final voltage, V_f , where V_s is the MPFCQor's nominal regulated output voltage and V_f is the MPFCQor's minimum output voltage limit. This energy equals the amount of power, P, which the DC-DC converters draw from the hold-up capacitor times the length of time, Δt , which it takes for the hold-up capacitor's voltage to drop from V_s to V_f . This energy can be equated to the hold-up capacitance according to the following formula:

$$\Delta E = P\Delta t = \frac{1}{2}C(V_s^2 - V_f^2)$$

This formula can be rearranged to find the minimum required value for C to provide the hold-up time desired for a given power level (note: this power level P is not the load power, but rather the load power divided by efficiency of the DC-DC converters):

$$C_{min} = 2P\Delta t / (V_s^2 - V_f^2)$$

For example, if we assume $P = 350W$, $\Delta t = 20ms$, $V_s = 270V$ and $V_f = 150V$, then we would want a hold-up capacitance of at least 280 μF .

NOTE: The MPFCQor is able to operate with a minimum of 100 μF of hold-up capacitance, but SynQor recommends at least 660 μF if the power system will be required to conform to lightning surge standards. This is because the MPFCQor relies on the hold-up capacitor to absorb most of the energy from a lightning surge.

NOTE: Even though the MPFCQor limits the inrush current drawn from the AC source during its startup sequence, it will not necessarily limit this current at the end of a temporary brownout or dropout of the AC source when the hold-up capacitor's voltage has not dropped below its minimum output voltage limit. In such a condition the MPFCQor will not reinitiate a startup sequence and it will therefore not limit the current flowing through it. If the peak of the AC source voltage is greater than the hold-up capacitor's voltage at the end of the brownout/dropout period, there will be a large inrush current for one half-cycle as the hold-up capacitor's voltage is charged up to the peak of the AC source voltage. The larger the hold-up capacitor, the larger this inrush current will be. To limit inrush current during this event, limit the charging current of additional hold-up capacitance with a resistor and diode as shown below.

If it is desired to have a hold-up time longer than can be achieved with the maximum specified hold-up capacitance, then the circuit shown below can be used.

Application Section

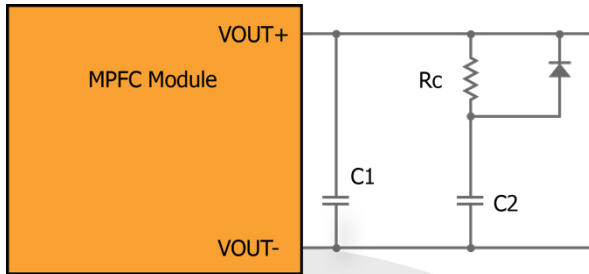

In this circuit the total hold-up capacitance is $(C1 + C2)$, and it can be made as large as desired as long as $C1$ does not exceed the maximum capacitance specified in the Technical Specifications table. The resistor, Rc , in series with $C2$ is present to limit the current that will charge this capacitor after a temporary brownout/dropout event. Its resistance should be large enough to limit the charging current to a fraction of the MPFCQor's rated output current. The diode in parallel with the resistor permits the load converters to draw whatever energy they need from $C2$ without being hindered by the resistor.

Output Ripple Considerations:

The hold-up capacitor must have a ripple current rating high enough to withstand the ripple current generated on the output of the MPFCQor. Ripple current amplitude is dependent only upon the total MPFCQor output power, P_{DC} , and the operating output voltage V_O . It can be calculated using the following formula:

$$I_{Crms} = \frac{P_{DC}}{\sqrt{2} \cdot V_O} = \frac{P_{DC}}{382}$$

The AC line frequency, f_{ac} , bulk capacitance, C , operating output voltage, and output power will determine the amplitude of the voltage ripple present on the output of the MPFCQor. It can be calculated with:

$$V_{pk-pk} = \frac{P_{DC}}{2\pi \cdot f_{ac} \cdot C \cdot V_O}$$

$$\text{At 60 Hz: } V_{pk-pk} = \frac{P_{DC}}{1.02 \cdot 10^5 \cdot C}$$

For example, to calculate voltage and current ripple for a MPFCQor with a 350W output, 400 μ F hold-up capacitor, and a 60Hz fundamental AC line frequency:

$$I_{Crms} = \frac{350W}{382} = 0.9A_{rms}$$

$$V_{pk-pk} = \frac{350W}{2\pi \cdot 60Hz \cdot 400 \cdot 10^{-6}F \cdot 270V} = 8.6V_{pk-pk}$$

In this case, the hold-up capacitor would require a minimum ripple current rating of 0.9A_{rms}, and the output voltage would have a pk-pk ripple voltage of 8.6V.

Safety Notes

The output of the MPFCQor is not isolated from the AC source, and it is therefore a hazardous voltage. Care must be taken to avoid contact with this voltage, as well as with the AC source voltage.

The MPFCQor must have a fuse in series with its AC source. The rating for this fuse is given in the Technical Specification table.

Thermal Consideration

The maximum operating base-plate temperature, T_B , is 100°C. Refer to the thermal derating curves to see the allowable power output for a given baseplate temperature and input voltage. A power derating curve can be calculated for any heatsink that is attached to the base-plate of the converter. It is only necessary to determine the thermal resistance, R_{THBA} , of the chosen heatsink between the base-plate and the ambient air for a given airflow rate. The following formula can then be used to determine the maximum power the converter can dissipate for a given thermal condition:

$$P_{diss}^{max} = \frac{T_B - T_A}{R_{THBA}}$$



MPFC-115-270-QP
Input:85-180Vrms
Output:270Vdc
Power:350W

Application Section

This value of power dissipation can then be used in conjunction with the data shown in the figures to determine the maximum load power that the converter can deliver in the given thermal condition.

MIL-STD-704 Power Level & Power Factor

All versions of MIL-STD-704 state that single-phase loads must draw less than 500VA of AC power. The MPFC's maximum output power complies with this requirement.

Section 5.4.3 of MIL-STD-704F states that AC equipment drawing greater than 100VA shall have no leading power factor. Most electronic loads, including the SynQor MPFC, contain a small amount of differential filter capacitance across the AC input, which draws a small amount of leading reactive power. This has a negligible effect on the power factor of the MPFC when it is drawing significant real power. Regardless, a small amount of leading power factor exists, and an exception to MIL-STD-704F section 5.4.3 must be taken. Use Figures 5 & 6 to determine the amount of leading power factor and ensure compatibility with the target AC power system.

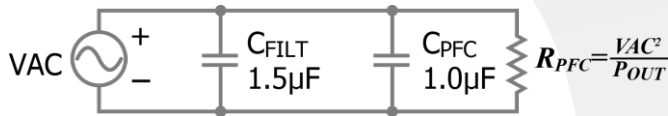

- C_{FILT} = MACF filter effective capacitance
- C_{PFC} = MPFC effective capacitance
- R_{PFC} = MPFC load
- P_{OUT} = MPFC total output power

This is an approximate representation of the input stage of the MPFC and MACF filter for the purpose of calculating the leading reactive power and power factor. The resistor represents in-phase current and varies with the load power. The capacitors represent the reactive current draw and are approximately constant over load.

MCOTS AC Line Filter

An AC line filter is needed to attenuate the differential- and common-mode voltage and current ripples created by the MPFCQor, the DC-DC converters, and the load, such that the system will comply with EMI requirements. The filter also provides protection for the MPFCQor from high frequency transients in the AC source voltage. SynQor has a family of AC line filters that will provide these functions. It is recommended that a metal-oxide varistor (MOV) be

placed from line-to-line on the input of the filter, and a TVS diode be placed from line-to-line on the output of the filter in order to keep the MPFCQor input voltage from exceeding 450V during all transients, except when the PFC is disabled, when the input can tolerate 575V transients for up to 100ms. See Figure A for example parts. If a non-SynQor AC line filter is used, the use of an MOV on the input and a TVS diode on the output of the filter is still recommended.

EMI Considerations

To meet various conducted line emission standards, additional Y-capacitors may be needed to attenuate common-mode noise. SynQor recommends that safety-rated ceramic capacitors be placed across any isolated DC-DC converters on the output of the PFC from V_{in-} to V_{out-} and V_{out-} to ground. However, the total capacitance from the PFC output leads to earth ground should not be more than 20nF if one of the PFC input leads is connected to earth ground. See "Typical Application of the PFC Module" (Figure A) for a diagram and suggested parts.



MPFC-115-270-QP
Input:85-180Vrms
Output:270Vdc
Power:350W

Encased Mechanical

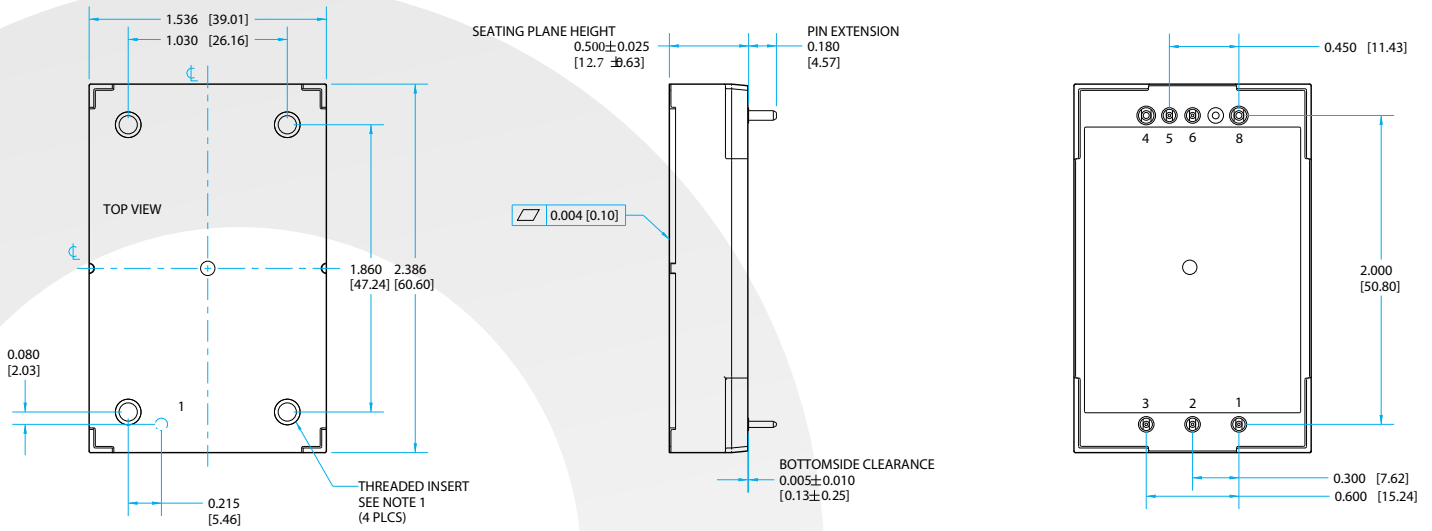

NOTES

- 1) Applied torque per screw should not exceed 6in-lb. (0.7 Nm). Screw should not exceed 0.100" (2.54mm) depth below the surface of the baseplate.
- 2) Baseplate flatness tolerance is 0.004" (.10 mm) TIR for surface.
- 3) Pins 1-3, 5-6 are 0.040" (1.02mm) diameter, with 0.080" (2.03mm) diameter standoff shoulders.
- 4) Pins 4 and 8 are 0.062" (1.57 mm) diameter with 0.100" (2.54 mm) diameter standoff shoulders.
- 5) All Pins: Material - Copper Alloy; Finish - Matte Tin over Nickel plate
- 6) Undimensioned components are shown for visual reference only.
- 7) Weight: 3.07 oz. (87 g)
- 8) All dimensions in inches (mm).
 Tolerances:
 x.xx +/-0.02 in. (x.x +/-0.5mm)
 x.xxx +/-0.010 in. (x.xx +/-0.25mm)
 unless otherwise noted.
- 9) Workmanship: Meets or exceeds IPC-A-610C Class II

PIN DESIGNATIONS		
Pin	Name	Function
1	L1	AC Line 1
2	PFC ENA	Negative Logic PFC Enable
3	L2/N	AC Line 2 / Neutral
4	-VOUT	Negative Output Voltage
5	AUX	Auxiliary Bias power supply
6	LOAD ENA	Negative Logic load enable and power out good signal
8	+VOUT	Positive Output voltage



MPFC-115-270-QP
Input:85-180Vrms
Output:270Vdc
Power:350W

Encased Mechanical with Flange

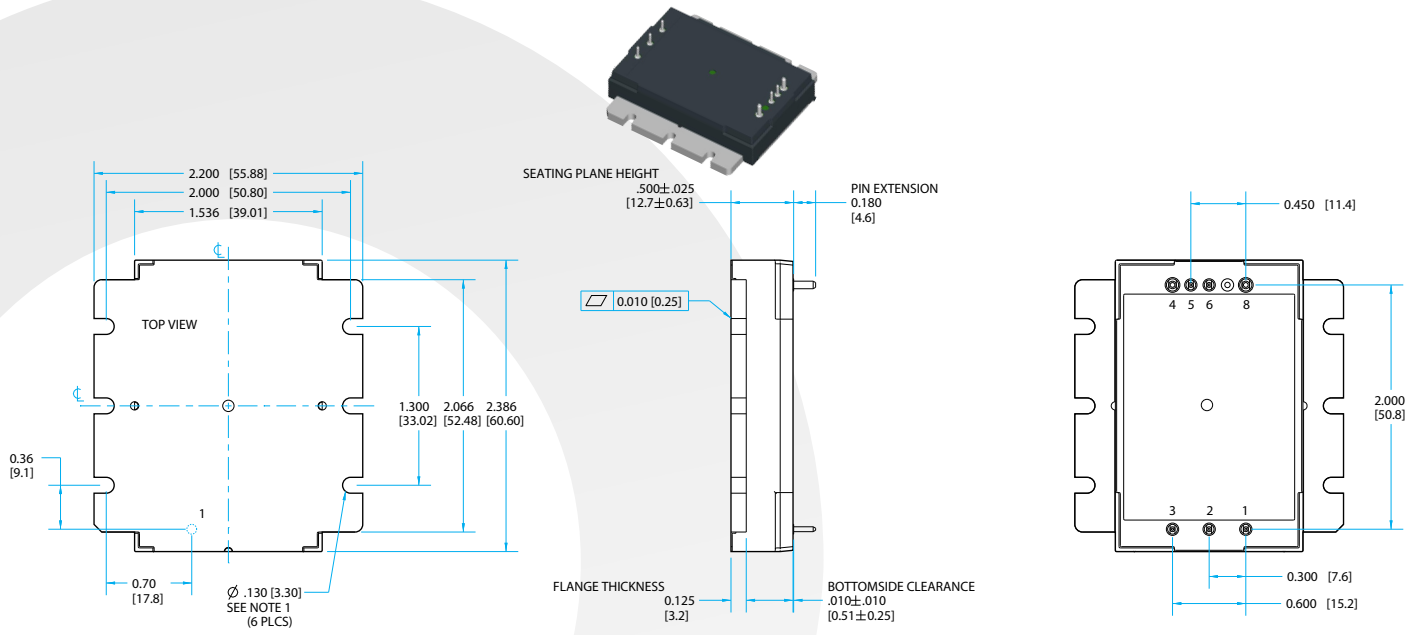

NOTES

- Applied torque per screw should not exceed 6in-lb. (0.7 Nm).
- Baseplate flatness tolerance is 0.010" (.2mm) TIR for surface.
- Pins 1-3, 5-6 are 0.040" (1.02mm) diameter, with 0.080" (2.03mm) diameter standoff shoulders.
- Pins 4 and 8 are 0.062" (1.57 mm) diameter with 0.100" (2.54 mm) diameter standoff shoulders.
- All Pins: Material - Copper Alloy; Finish - Matte Tin over Nickel plate
- Undimensioned components are shown for visual reference only.
- Weight: 3.32 oz. (94 g)
- All dimensions in inches (mm).
Tolerances:
x.xx +/-0.02 in. (x.x +/-0.5mm)
x.xxx +/-0.010 in. (x.xx +/-0.25mm)
unless otherwise noted.
- Workmanship: Meets or exceeds IPC-A-610C Class II

PIN DESIGNATIONS

Pin	Name	Function
1	L1	AC Line 1
2	PFC ENA	Negative Logic PFC Enable
3	L2/N	AC Line 2 / Neutral
4	-VOUT	Negative Output Voltage
5	AUX	Auxiliary Bias power supply
6	LOAD ENA	Negative Logic load enable and power out good signal
8	+VOUT	Positive Output voltage



MPFC-115-270-QP
Input:85-180Vrms
Output:270Vdc
Power:350W

Ordering Information

Ordering Information / Part Numbering Scheme

Family	Input Voltage	Output Voltage	Package Size	Thermal Design	Screening Level
MPFC	115: 85-180V	270: 270V	QP: Quarter-brick Peta	N: Encased F: Encased with Flanged Baseplate	S: S-Grade M: M-Grade

Example: MPFC-115-270-QP-N-M

PART NUMBERING SYSTEM

The part numbering system for SynQor’s ac-dc converters follows the format shown in the example.

APPLICATION NOTES

A variety of application notes and technical white papers can be downloaded in pdf format from our website.

STANDARDS COMPLIANCE

Input/Output to baseplate isolation 2150Vdc	Basic Insulation to Baseplate
CE Marked	

Note: An external input fuse must always be used to meet these safety requirements. Contact SynQor for official safety certificates on new releases or download from the SynQor website.

Contact SynQor for further information and to order:

Phone: 978-849-0600 Toll Free: 888-567-9596 Fax: 978-849-0602

E-mail: power@synqor.com Web: www.synqor.com

Address: 155 Swanson Road, Boxborough, MA 01719 USA

WARRANTY

SynQor offers a two (2) year limited warranty. Complete warranty information is listed on our website or is available upon request from SynQor.

PATENTS

SynQor holds numerous U.S. patents, one or more of which apply to most of its power conversion products. Any that apply to the product(s) listed in this document are identified by markings on the product(s) or on internal components of the product(s) in accordance with U.S. patent laws. SynQor’s patents include the following:

6,896,526	6,927,987	7,050,309	7,765,687
7,787,261	8,149,597	8,644,027	