



MPFIC-U-55-FG

Isolated PFC Module

Full-brick

Military Isolated Power Factor Correction Module

85-264Vrms Input Voltage	47 - 63Hz / 360 - 800Hz Input Frequency	55Vdc Output Voltage	10.9A Output Current	≥0.99 Power Factor	90%@115Vrms / 92%@230Vrms Full Load Efficiency
------------------------------------	---	--------------------------------	--------------------------------	------------------------------	--

The MPFICQor Military Isolated PFC Module is a high power, high efficiency AC-DC converter. It operates from a universal AC input and generates an isolated output. Both regulated and semi-regulated (droop version) modules are available. Used in conjunction with a hold-up capacitor, and SynQor’s MCOTS AC line filter, the MPFICQor will draw a nearly perfect sinusoidal current (PF>0.99) from a single phase AC input. The module is supplied completely encased to provide protection from the harsh environments seen in many military and aerospace environments.



Designed and manufactured in the USA

Operational Features

- Isolated output, 600W output power
- **Output remains in regulation during input dropout event**
- Universal input frequency range: 47 - 63Hz / 360 - 800Hz
- Input voltage range: 85-264Vrms
- ≥0.99 Power Factor
- High efficiency: 92% (230Vrms)
- Minimal inrush current
- Secondary side control pins with 3.3V standby power
- Can be paralleled (droop version only)

Mechanical Features

- Industry standard full-brick package
- Size: 2.486" x 4.686" x 0.512" (63.14 x 119.02 x 13.0 mm)
- Total weight: 11.3oz (320g)
- Flanged baseplate version available

Protection Features

- Input current limit and auto-recovery short circuit protection
- Auto-recovery input under/over-voltage protection
- Auto-recovery over-voltage protection
- Auto-recovery thermal shutdown

Safety Features

- (Pending)
- Input to output reinforced isolation 4250Vdc
 - Input/Output to baseplate isolation 2500Vdc
 - CE Marked

Control Features

- All control pins referenced to secondary side
- Asynchronous serial data interface
- AC and DC Power Good outputs
- PFC Enable and Battle Short inputs
- 3.3V standby power and clock synchronization output

Compliance Features

- Designed to meet these standards when used with SynQor MACF Filters.
- MIL-STD-461(A-F)
 - MIL-STD-1399
 - MIL-STD-704-2, -704-4, & -704-6* (see 704 app section)

Contents

Typical Application	2
Technical Specification	3
Screening & Qualification Testing	9
Application Section	10
Encased Mechanical	16
Encased Mechanical with Flange	17
Ordering Information	18

Typical Application

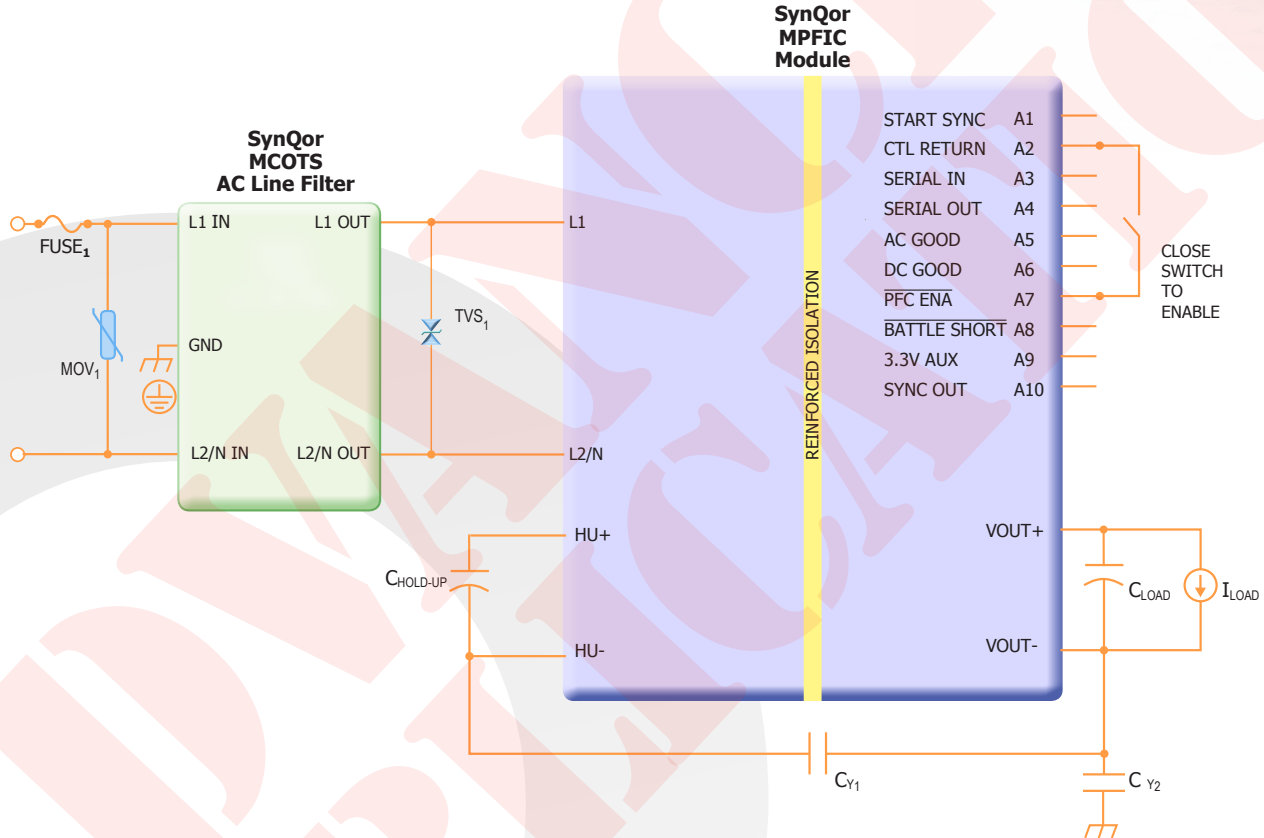

FUSE₁: 12.5A / 250V Fuse
MOV₁, TVS₁: Must prevent peak voltage from exceeding 575V during all transients. Must also not be acting for the desired operating range.
C_{Hold-Up}: 100 - 1000 μ F (Dependent on Power Level and Line Frequency)
C_{Y1-Y2}: See "EMI Considerations" in application notes

Example Parts:

FUSE₁: 250VAC, 12.5A; Littelfuse 021612.5MXEP
MOV₁: 300VAC, 60J; EPCOS S10K300E2
TVS₁: 400V, 3J; two VISHAY 1.5KE200CA devices connected in series
C_{Hold-Up}: One 450V, 330 μ F; EPCOS B43508B5337M (-40°C)
 Two 200V, 720 μ F; Cornell Dubilier MLSG721M250EB0C **in series** with balancing resistors (-55°C)
C_{Y1}: 3.3nF, 500VAC; Vishay VY1332M59Y5UQ6TV0
C_{Y2}: 10nF, 300VAC; Vishay VY2103M63Y5US63V7

Figure A: Typical Application of the MPFICQor module to create an AC-DC Power Supply



MPFIC-U-55-FG
Input:85-264Vrms
Output:55Vdc
Current:10.9A

Technical Specification

MPFIC-U-55-FG Electrical Characteristics

Operating conditions of 115Vrms, 60Hz input, 10.9A output, 600µF bulk capacitance, 1mF output capacitance, baseplate at 25°C; full operating baseplate temperature range is -55 °C to +100 °C with appropriate power derating. Specifications subject to change without notice.

Parameter	Min.	Typ.	Max.	Units	Notes & Conditions
ABSOLUTE MAXIMUM RATINGS					
Input Voltage (L1 to L2/N)			575	Vpk	
Isolation Voltage (Input to Output)			4250	Vdc	See Note 3
Isolation Voltage (Input/Output to Baseplate)			2500	Vdc	See Note 3
Operating Temperature	-55		100	°C	Baseplate temperature
Storage Temperature	-65		125	°C	
SERIAL IN and PFC ENA inputs	-2		7	V	Relative to CTL RETURN pin
AC GOOD, DC GOOD, and BATTLE SHORT outputs					
Pull Up Voltage	-2		7	V	Relative to CTL RETURN pin
Sink Current			10	mA	
INPUT CHARACTERISTICS (L1 to L2/N)					
Operating Input Voltage Range					
AC Input Continuous	85		264	Vrms	
AC Input 100ms Transient	40		290	Vrms	
Input Under-Voltage Lockout		30		Vrms	>1s duration
Input Over-Voltage Shutdown		440		Vpk	
Operating Input Frequency	47		800	Hz	
Power Factor of AC Input Current		0.99			50/60Hz, min 400W output
		0.97			400Hz, min 400W output
Total Harmonic Distortion of AC Input Current		3		%	
Inrush of AC Input Current			1	A	When used with SynQor AC line filter
Enabled AC Input Current (no load)		180		mArms	115 Vrms input, when used with SynQor filter
Disabled AC Input Current		50		mArms	115 Vrms input, when used with SynQor filter
Maximum Input Power			750	W	
Maximum Input Current			9.0	Arms	85 Vrms input
Input Differential Mode Capacitance		1		µF	
OUTPUT CHARACTERISTICS					
Output Voltage Set Point at Full Load					See Figure 11 for V-I curve
Standard Option	54.4	55.0	55.6	Vdc	Vin<250Vrms, for higher Vin see application notes
Droop Option	52.0	52.6	53.2	Vdc	
Droop Option, Current Share Analysis	52.4	52.6	52.8	Vdc	Tolerance for droop share operation, see Note 4
Total Output Voltage Range					See Figure 11 for V-I curve
Standard Option	54.0		57.0	Vdc	Vin<250Vrms, for higher Vin see application notes
Droop Option	52.0		58.0	Vdc	
Standard Option Voltage Regulation					Above half load
Over Line		±0.3		%	Vin<250Vrms, for higher Vin see application notes
Over Load		±2.0		%	
Over Temperature		±1.5		%	
Operating Output Current Range	0		10.9	A	
Output Current Limit					Unit continues to operate for 1s before shutdown
115 Vrms		12		A	For standard option
230 Vrms		13		A	For standard option
Maximum Output Capacitance			2,000	µF	At half resistive load
Minimum Output Capacitance		500		µF	
HOLD-UP CHARACTERISTICS					
Typical Hold-up Voltage		400		Vdc	
Hold-up Voltage Range	380		435	Vdc	Hold-up voltage varies with load
Hold-up Over-Voltage Protection Threshold	440		460	Vdc	
Hold-up Under-Voltage Shutdown Threshold		200		Vdc	
Hold-up Capacitance	100		1000	µF	See Note 2
Efficiency					
100% Load at 115Vrms		90		%	See Figure 1 for efficiency curve
100% Load at 230Vrms		92		%	See Figure 1 for efficiency curve

Note 1: 600µF electrolytic hold-up capacitor having a typical ESR of 0.5Ω. Ripple amplitude dependent on capacitance and ESR of hold-up capacitor.

Note 2: The MPFICQor is able to operate with a minimum of 100µF of hold-up capacitance, but SynQor recommends at least 330µF if the power system will be required to conform to lightning surge standards. This is because the MPFICQor relies on the hold-up capacitor to absorb the energy from a lightning surge.

Note 3: 1 minute for qualification test, and less than 1 minute in production.

Note 4: For use with droop share analysis. Assumes uniform thermal environment for modules in parallel.

Technical Specification

MPFIC-U-55-FG Electrical Characteristics (continued)

Operating conditions of 115Vrms, 60Hz input, 10.9A output, 600µF bulk capacitance, 1mF output capacitance, baseplate at 25°C; full operating baseplate temperature range is -55 °C to +100 °C with appropriate power derating. Specifications subject to change without notice.

Parameter	Min.	Typ.	Max.	Units	Notes & Conditions
ISOLATION CHARACTERISTICS (Input to output)					
Isolation Test Voltage (Dielectric Strength)					See Absolute Maximum Ratings, Note 3
Isolation Resistance	100			MΩ	
Isolation Capacitance		100		pF	
ISOLATION CHARACTERISTICS (Input/output to baseplate)					
Isolation Test Voltage (Dielectric Strength)					See Absolute Maximum Ratings, Note 3
Isolation Resistance	100			MΩ	
TEMPERATURE LIMITS FOR POWER DERATING CURVES					
Semiconductor Junction Temperature			125	°C	
Board Temperature			125	°C	
Transformer Temperature			125	°C	
Maximum Baseplate Temperature, T _B			100	°C	
Over-Temperature Protection					Measured at surface of internal PCB
Disable Threshold		125		°C	
Warning Threshold		120		°C	Warning causes BATTLE SHORT pin to go high
Enable Threshold		120		°C	
FEATURE CHARACTERISTICS					
Hold-up Capacitor Precharge					
Precharge Current		50		mA	
Hold-up Short-Circuit Withstand			indefinite	s	
Free Running Switching Frequency		200		kHz	
PFC ENA (negative logic)					PFC enable input (pull low to enable unit)
Off State Input Voltage	2.4			V	
On State Input Voltage			0.8	V	
Internal Pull-Up Voltage		3.3		V	
Internal Pull-Up Resistance		10		kΩ	
SERIAL IN					
Idle / Stop State Input Voltage	2.4			V	
Zero / Start State Input Voltage			0.8	V	
Internal Pull-Up Voltage		3.3		V	
Internal Pull-Up Resistance		10		kΩ	
SERIAL OUT					
Idle / Stop State Output Voltage	2.9	3.1		V	4 mA source current
Zero / Start State Output Voltage		0.2	0.4	V	4 mA sink current
AC Good (AC GOOD)					Referenced to CTL RETURN
AC Input Voltage for AC Good	119		375	Vpk	
Low State Output Voltage		0.2	0.4	V	2 mA sink current
Internal Pull-Up Voltage		3.3		V	
Internal Pull-Up Resistance		10		kΩ	
DC Good (DC GOOD)					Referenced to CTL RETURN
Low State Output Voltage		0.2	0.4	V	2 mA sink current
Internal Pull-Up Voltage		3.3		V	
Internal Pull-Up Resistance		10		kΩ	
BATTLE SHORT (negative logic)					Battle short input (pull low to disable protection)
Normal State Input Voltage	2.4			V	
Protection-Disabled State Input Voltage			0.8	V	
Internal Pull-Up Voltage		3.3		V	
Internal Pull-Up Resistance		10		kΩ	
3.3V AUX					3.3 V output always on regardless of PFC ENA state
Output Voltage Range	3.19	3.30	3.43	V	Over line, load, temp, and life
Source Current			100	mA	
SYNC OUT					Synchronization output at switching frequency
High State Output Voltage	2.9	3.1		V	4 mA source current
Low State Output Voltage		0.2	0.4	V	4 mA sink current
RELIABILITY CHARACTERISTICS					
Calculated MTBF (MIL-217) MIL-HDBK-217F		557		kHrs	Ground Benign, T _B = 70°C
Calculated MTBF (MIL-217) MIL-HDBK-217F		78		kHrs	Ground Mobile, T _B = 70°C



MPFIC-U-55-FG
Input: 85-264Vrms
Output: 55Vdc
Current: 10.9A

Technical Specification

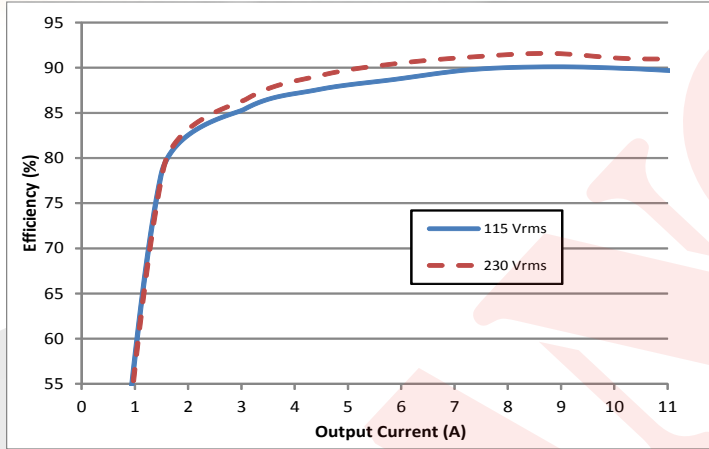

Figure 1: Efficiency at nominal output voltage vs. output current for 115Vrms and 230Vrms input voltage (applies to both 60Hz and 400Hz) at $T_b = 25^\circ\text{C}$.

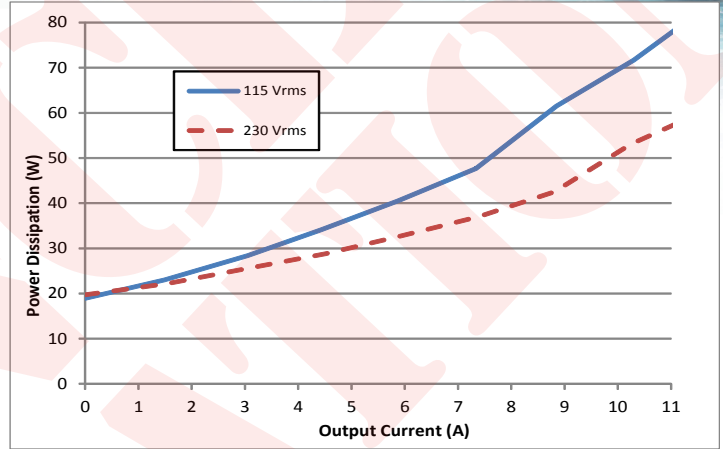

Figure 2: Power dissipation at nominal output voltage vs. output current for 115Vrms and 230Vrms input voltage (applies to both 60Hz and 400Hz) at $T_b = 25^\circ\text{C}$.

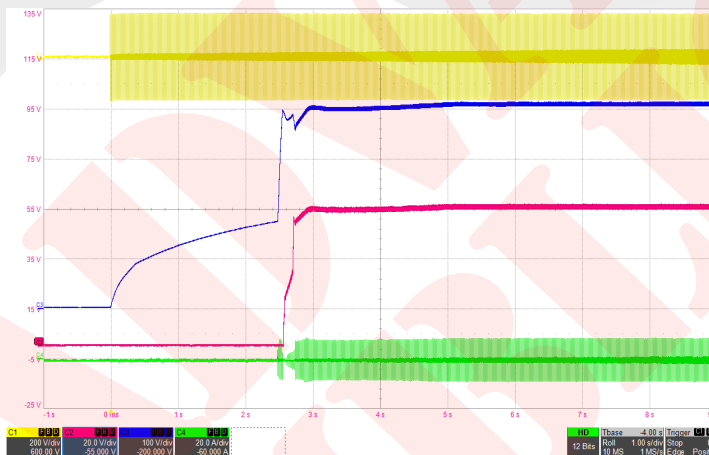

Figure 3: Typical startup waveform with 600 μF hold-up capacitor (115Vrms, 60Hz) Ch1: Vin (200V/div), Ch2: Vout (20V/div), Ch3: Hold-up capacitor voltage (100V/div), Ch4: Iin (20A/div), Timebase: (1s/div).

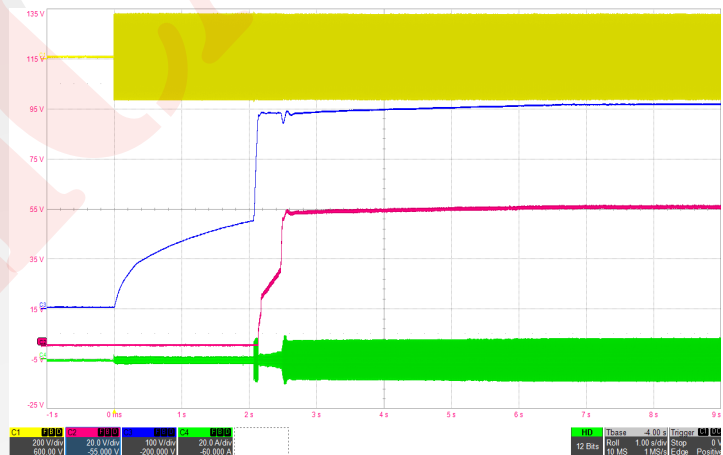

Figure 4: Typical startup waveform with 600 μF hold-up capacitor (115Vrms, 400Hz) Ch1: Vin (200V/div), Ch2: Vout (20V/div), Ch3: Hold-up capacitor voltage (100V/div), Ch4: Iin (20A/div), Timebase: (1s/div).

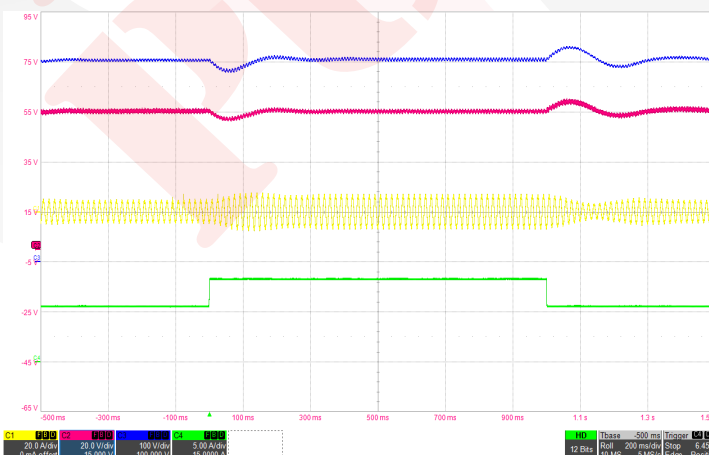

Figure 5: Load transient with 600 μF hold-up capacitor (50%-75%-50% of I_{max} , 115Vrms, 60Hz) Ch1: Iin (20A/div), Ch2: Vout (20V/div), Ch3: Hold-up capacitor voltage (100V/div), Ch4: Iout (5A/div), Timebase: (200ms/div).

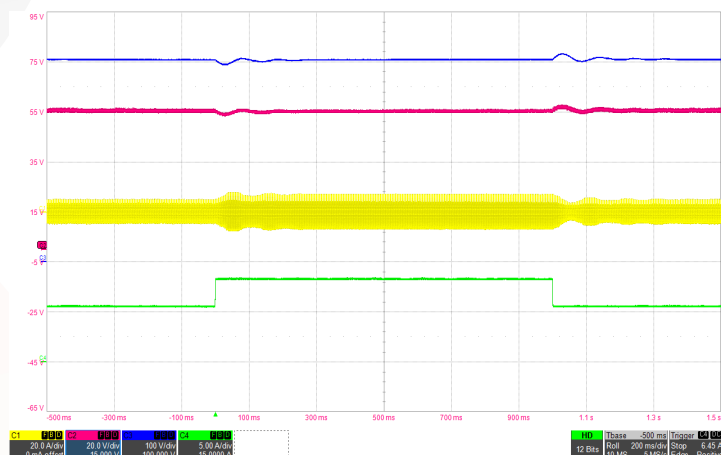

Figure 6: Load transient with 600 μF hold-up capacitor (50%-75%-50% of I_{max} , 115Vrms, 400Hz) Ch1: Iin (20A/div), Ch2: Vout (20V/div), Ch3: Hold-up capacitor voltage (100V/div), Ch4: Iout (5A/div), Timebase: (200ms/div).



MPFIC-U-55-FG
Input: 85-264Vrms
Output: 55Vdc
Current: 10.9A

Technical Specification

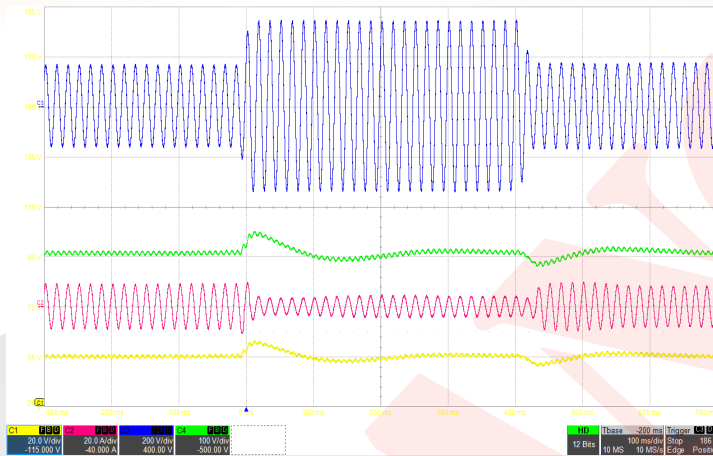

Figure 7: Input transient with 600µF hold-up capacitor at full load (115Vrms-220Vrms-115Vrms, 60Hz) Ch1: Vout (20V/div), Ch2: Iin (20A/div), Ch3: Vin (200V/div), Ch4: Vhold-up (100V/div), Timebase: (100ms/div).

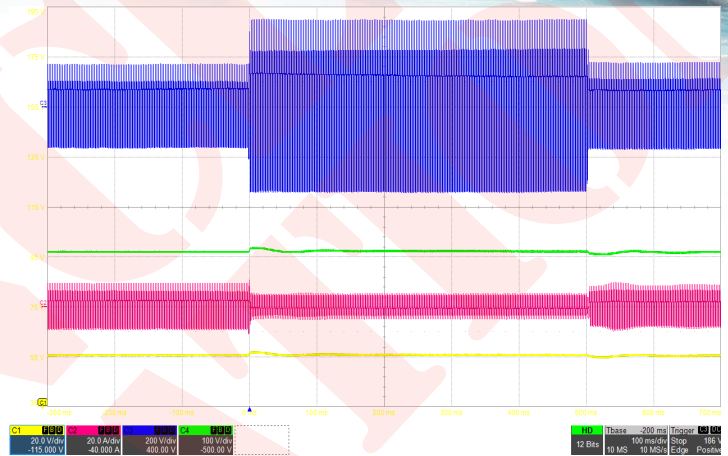

Figure 8: Input transient with 600µF hold-up capacitor at full load (115Vrms-220Vrms-115Vrms, 400Hz) Ch1: Vout (20V/div), Ch2: Iin (20A/div), Ch3: Vin (200V/div), Ch4: Vhold-up (100V/div), Timebase: (100ms/div).

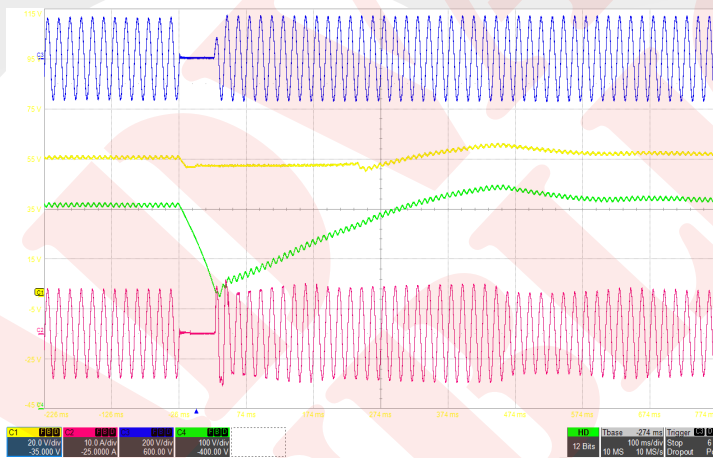

Figure 9: Line drop out with 600µF hold-up capacitor at full load (115Vrms, 60Hz) Ch1: Vout (20V/div), Ch2: Iin (10A/div), Ch3: Vin (200V/div), Ch4: Vhold-up (100V/div), Timebase: (100ms/div).

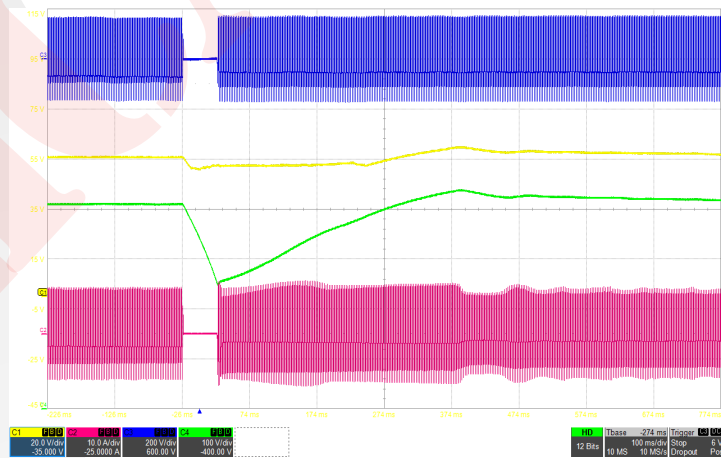

Figure 10: Line drop out with 600µF hold-up capacitor at full load (115Vrms, 400Hz) Ch1: Vout (20V/div), Ch2: Iin (10A/div), Ch3: Vin (200V/div), Ch4: Vhold-up (100V/div), Timebase: (100ms/div).

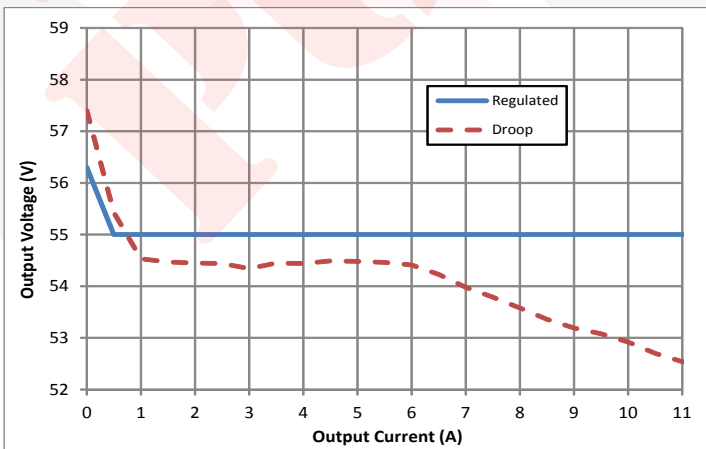

Figure 11: Typical output voltage vs. output current for regulated and droop outputs.

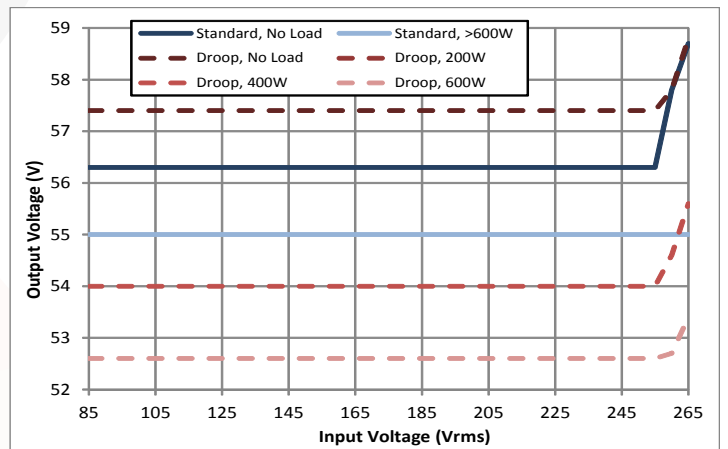

Figure 12: Typical output voltage vs. input voltage for regulated and droop outputs at different output powers.



Technical Specification

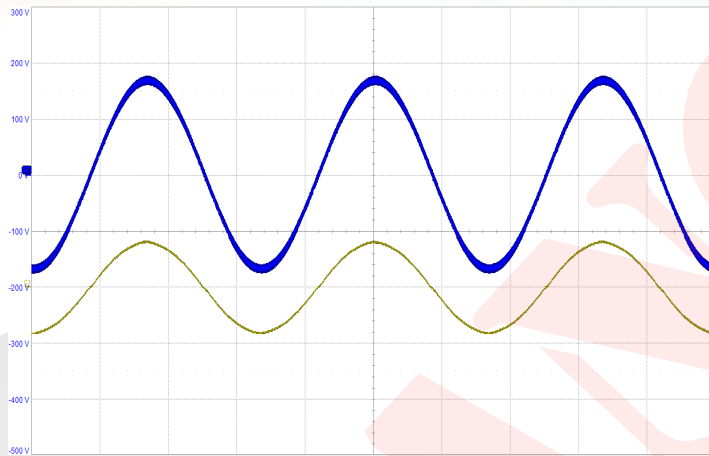

Figure 13: Typical Input Voltage and Current waveforms at full load current (115Vrms, 60Hz) Top: Vin (100V/div), Bottom: Iin (10A/div), Timebase: (5ms/div).

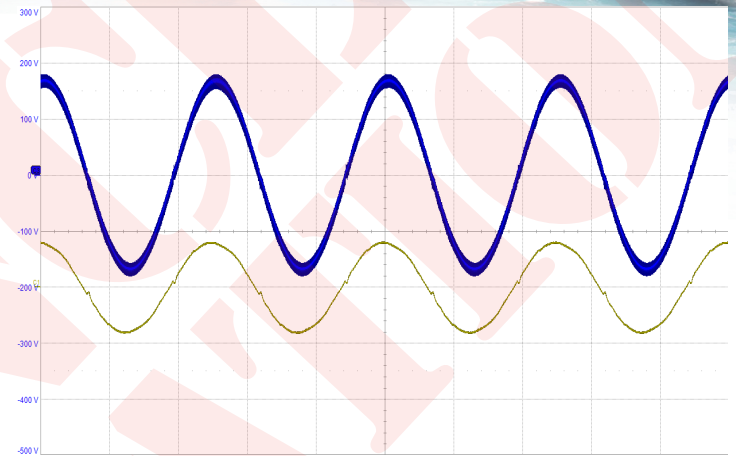

Figure 14: Typical Input Voltage and Current waveforms at full load current (115Vrms, 400Hz) Top: Vin (100V/div), Bottom: Iin (10A/div), Timebase: (1ms/div).

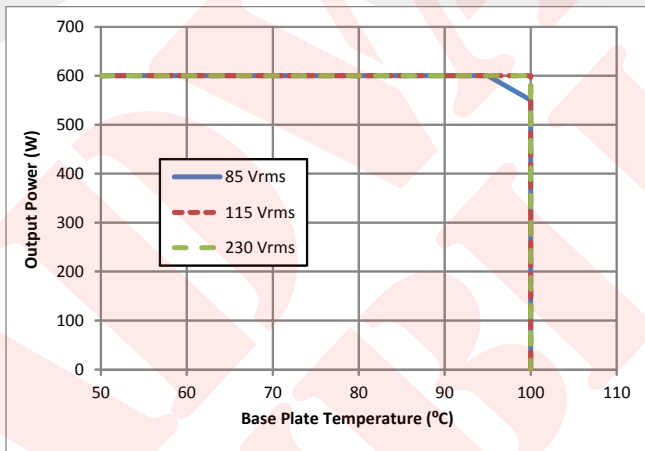

Figure 15: Maximum output current vs. base plate temperature derating curve.

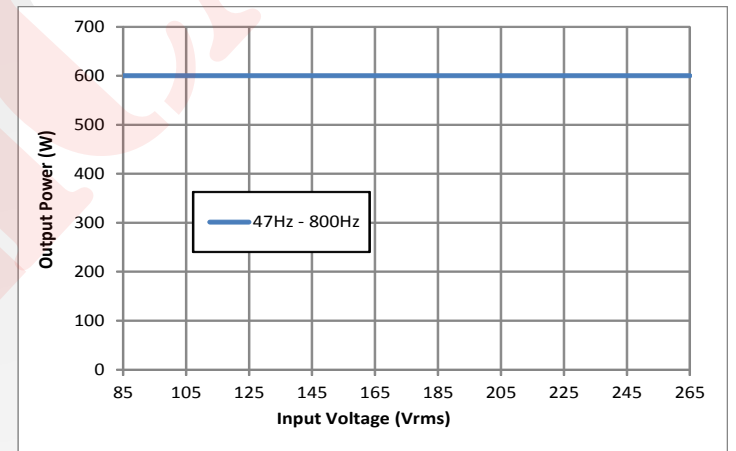

Figure 16: Maximum output power vs. input voltage at different input voltages.

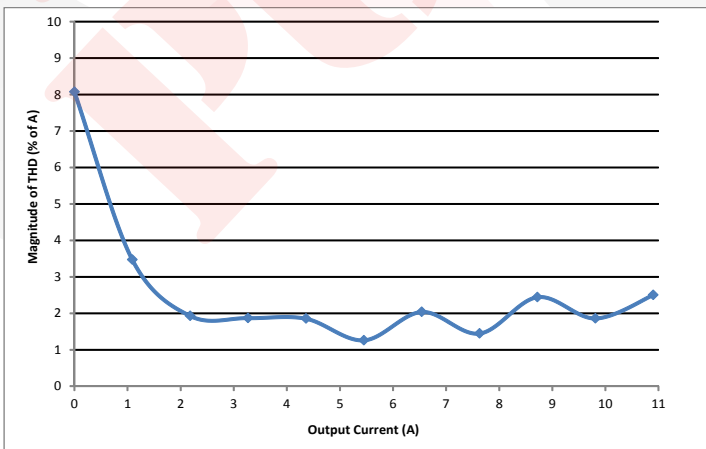

Figure 17: Total harmonic distortion (THD) at 115Vrms, 60Hz vs. output current (Tested with MPFIC module and MACF-060-230-HT filter).

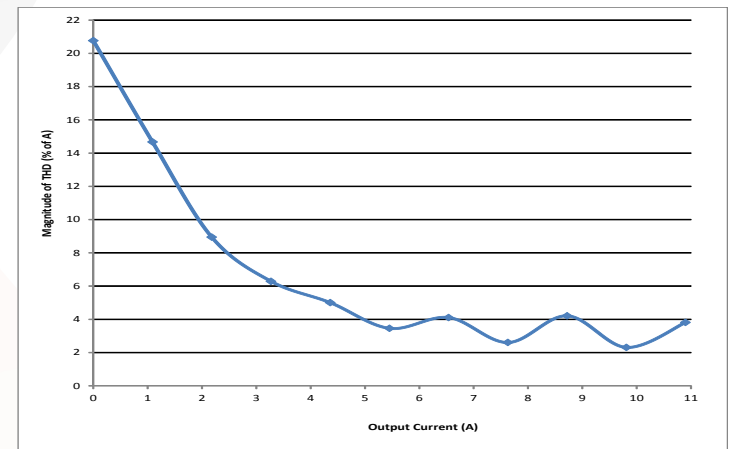

Figure 18: Total harmonic distortion (THD) at 115Vrms, 400Hz vs. output current (Tested with MPFIC module and MACF-400-230-HT filter).



MPFIC-U-55-FG
Input: 85-264Vrms
Output: 55Vdc
Current: 10.9A

Technical Specification

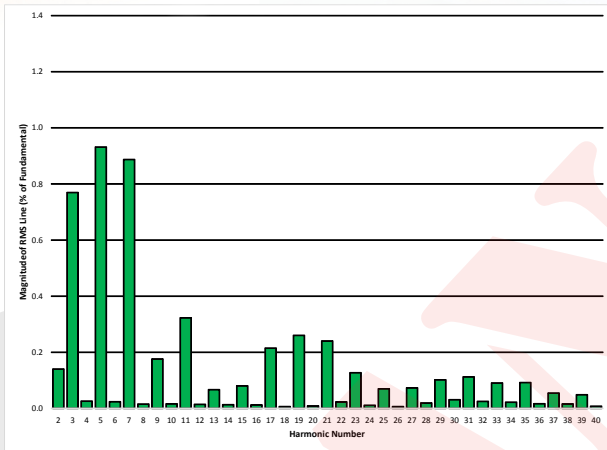

Figure 19: Input current harmonic components at full load, 115Vrms 60 Hz, T=25°C (Tested with MPFIC module and MACF-060-230-HT filter).

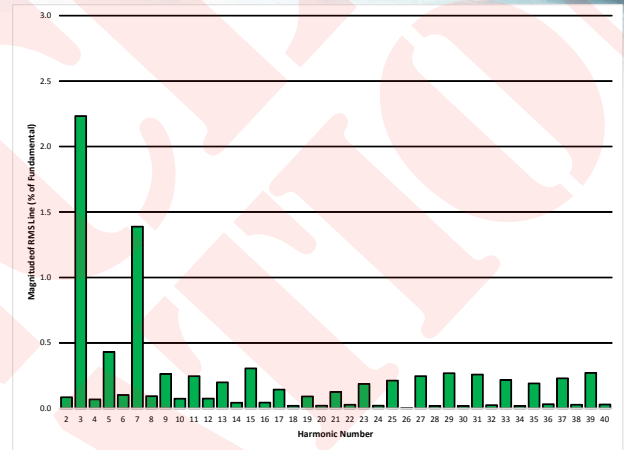

Figure 20: Input current harmonic components at full load, 115Vrms 400 Hz, T=25°C (Tested with MPFIC module and MACF-400-230-HT filter).

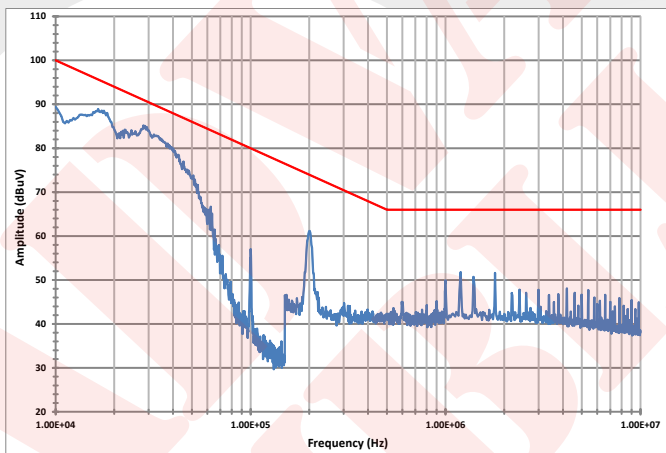

Figure 21: MIL-STD-461F CE102 conducted emissions, 115Vrms 60 Hz, T=25°C (Tested with MPFIC module and MACF-060-230-HT filter).

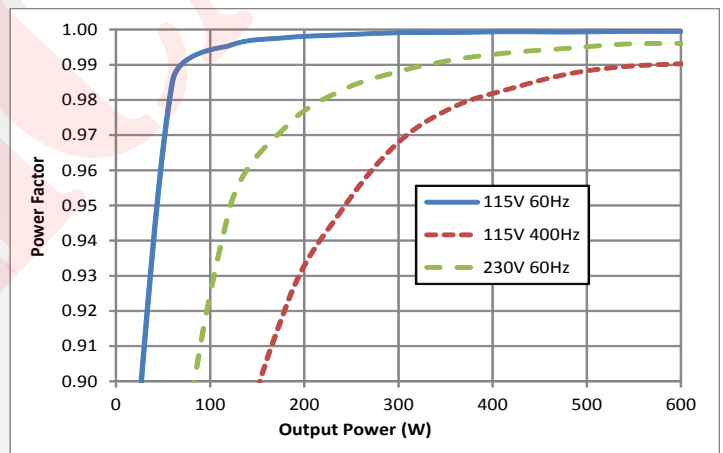

Figure 22: Power factor vs. output power at different input conditions, T=25°C (Tested with MPFIC module and MACF-060-230-HT filter).



MPFIC-U-55-FG
Input: 85-264Vrms
Output: 55Vdc
Current: 10.9A

Screening & Qualification Testing
Mil-COTS Qualification

Test Name	Details	# Tested (# Failed)	Consistent with MIL-STD-883F Method
Life Testing	Visual, mechanical and electrical testing before, during and after 1000 hour burn-in @ full load	15 (0)	Method 1005.8
Shock-Vibration	Visual, mechanical and electrical testing before, during and after shock and vibration tests	5 (0)	MIL-STD-202, Methods 201A & 213B
Humidity	+85 °C, 95% RH, 1000 hours, 2 minutes on / 6 hours off	8 (0)	Method 1004.7
Temperature Cycling	500 cycles of -55 °C to +100 °C (30 minute dwell at each temperature)	10 (0)	Method 1010.8, Condition A
Solderability	15 pins	15 (0)	Method 2003
DMT	-65 °C to +110 °C across full line and load specifications in 5 °C steps	7 (0)	
Altitude	70,000 feet (21 km), see Note	2 (0)	

Note: A conductive cooling design is generally needed for high altitude applications because of naturally poor convective cooling at rare atmospheres.

Mil-COTS Converter and Filter Screening

Screening	Process Description	S-Grade	M-Grade
Baseplate Operating Temperature		-55 °C to +100 °C	-55 °C to +100 °C
Storage Temperature		-65 °C to +135 °C	-65 °C to +135 °C
Pre-Cap Inspection	IPC-A-610, Class III	•	•
Temperature Cycling	MIL-STD-883F, Method 1010, Condition B, 10 Cycles		•
Burn-In	100 °C Baseplate	12 Hours	96 Hours
Final Electrical Test	100%	25 °C	-55 °C, +25 °C, +100 °C
Final Visual Inspection	MIL-STD-883F, Method 2009	•	•

Mil-COTS MIL-STD-810G Qualification Testing

MIL-STD-810G Test	Method	Description
Fungus	508.6	Table 508.6-I
Altitude	500.5 - Procedure I	Storage: 70,000 ft / 2 hr duration
	500.5 - Procedure II	Operating: 70,000 ft / 2 hr duration; Ambient Temperature
Rapid Decompression	500.5 - Procedure III	Storage: 8,000 ft to 40,000 ft
Acceleration	513.6 - Procedure II	Operating: 15 g
Salt Fog	509.5	Storage
High Temperature	501.5 - Procedure I	Storage: 135 °C / 3 hrs
	501.5 - Procedure II	Operating: 100 °C / 3 hrs
Low Temperature	502.5 - Procedure I	Storage: -65 °C / 4 hrs
	502.5 - Procedure II	Operating: -55 °C / 3 hrs
Temperature Shock	503.5 - Procedure I - C	Storage: -65 °C to 135 °C; 12 cycles
Rain	506.5 - Procedure I	Wind Blown Rain
Immersion	512.5 - Procedure I	Non-Operating
Humidity	507.5 - Procedure II	Aggravated cycle @ 95% RH (Figure 507.5-7 aggravated temp - humidity cycle, 15 cycles)
Random Vibration	514.6 - Procedure I	10 - 2000 Hz, PSD level of 1.5 g ² /Hz (54.6 g _{rms}), duration = 1 hr/axis
Shock	516.6 - Procedure I	20 g peak, 11 ms, Functional Shock (Operating no load) (saw tooth)
	516.6 - Procedure VI	Bench Handling Shock
Sinusoidal vibration	514.6 - Category 14	Rotary wing aircraft - helicopter, 4 hrs/axis, 20 g (sine sweep from 10 - 500 Hz)
Sand and Dust	510.5 - Procedure I	Blowing Dust
	510.5 - Procedure II	Blowing Sand

Application Section

Basic Operation & Features

The MPFICQor isolated power factor correction module is a high efficiency, high power AC-DC converter. It operates from a universal AC input to generate an isolated DC output voltage. Both regulated and semi-regulated (droop version) modules are available. As shown in **Figure A**, a typical power supply would be comprised of a SynQor MCOTS AC Line Filter, a SynQor MPFICQor module and an energy storage hold-up capacitor. A fuse is needed to meet safety requirements.

One of the primary purposes of the MPFICQor is to shape the input current that is drawn from a single-phase sinusoidal AC source into a nearly perfect sinusoidal waveform so that the AC-DC power supply will present a very high power factor load to this source. In doing this wave-shaping, the MPFICQor ensures that the harmonic components of the AC current waveform are below the levels called for in military standards such as MIL-STD-1399 and MIL-STD-704. The total harmonic distortion of the AC current waveform is typically less than 3% at full load.

The MPFICQor accomplishes its wave-shaping task by first rectifying the filtered AC source voltage, and then processing the input power through a non-isolated, high-efficiency, high-frequency “boost converter” that both gives the input AC current its sinusoidal shape and provides a regulated DC voltage across the hold-up capacitor. This stage is then followed by a highly efficient, fixed duty cycle isolation stage, which provides the isolated output voltage. For Regulated-output model, the output voltage is sensed and this information is sent to the primary side control circuitry through a digital isolator. The DC voltage across the hold-up capacitor is then adjusted to keep the output voltage regulated.

The hold-up capacitor handles the cyclic imbalance between the flow of energy drawn from the AC source and the flow of energy delivered to the load. This energy imbalance has a cyclic frequency twice that of the AC source voltage (e.g. 120Hz for a 60Hz input). This relatively low frequency makes the hold-up capacitor relatively large. Another purpose of the hold-up capacitor is to be a source of energy so that the output can continue to deliver load power during a temporary brownout or dropout of the AC source. A typical power supply will have sufficient hold-up capacitor to give a “hold-up time” in the 20ms range, but longer times can be achieved with yet more hold-up capacitance.

Besides shaping the AC current waveform, the MPFICQor performs several other important functions. It has current limit controlled pre-charger that ensures input inrush current is nearly zero even with very large holdup capacitors. It has both output current limit and short circuit protection. It will also shut-down if the AC input voltage is out of its range (either too high or too

low) for too long, or if the temperature of the module is too high.

In addition, the MPFICQor has several control signals that are described in more detail below. It also has 3.3V AUX supply that can source up to 100 mA. All control signals and 3.3V AUX are secondary side referenced.

Start-up Sequence

When the AC source voltage is first applied, regardless of whether the MPFICQor is enabled or disabled through its **PFC_ENA** pin, the MPFICQor will pre-charge the output hold-up capacitor with a current limited to approximately 50 mA. If the MPFICQor is enabled, this pre-charging continues until the hold-up voltage is higher than the peak voltage of the AC source. This actively controlled pre-charger limits the input inrush current to be nearly zero. If the MPFICQor is disabled, the MPFICQor will remain in the pre-charged state indefinitely. The typical hold-up voltage when disabled is about 180 V. It may vary with application.

When the **PFC_ENA** input pin is pulled low, and after the pre-charging is completed if it is not already, the boost converter within the MPFICQor will start operating and the MPFICQor’s hold-up voltage will be increased to its nominal regulated value. After this regulated voltage level is achieved, the isolation stage within the MPFICQor will then start operating. The converter’s output voltage will rise to its nominal value.

If the **PFC_ENA** input is de-asserted (pulled high or allowed to float), the boost converter, as well as the isolation stage, in the MPFICQor will shut down.

NOTE: Under extreme conditions, such as when 3.3V AUX is loaded with more than its rated current or power is being drawn from hold-up terminals, the pre-charger may not be able to charge the hold-up voltage above the peak voltage of the AC source. This may cause large inrush current when MPFICQor attempts to turn on when it is enabled.

The voltage across the hold-up capacitor will remain in a charged state after the MPFICQor is disabled as long as the AC source voltage is present.

Brownout/Dropout Sequence

If the AC source voltage is present but it is below its continuous minimum input voltage limit, the MPFICQor will still draw whatever power it can (within its current limit) from the AC source. This power may not be enough for the total load power, in which case the hold-up capacitor will provide the balance of the power.

Application Section

The MPFICQor hold-up module has control circuitry that will keep output voltage in regulation even as hold-up capacitor discharges. Using the maximum specified output capacitance on the hold-up module is recommended.

If and when the voltage across the hold-up capacitor drops below its specified minimum limit, the isolation stage will stop operating and output will be turned off. This condition will cause the MPFICQor to return to the beginning of the startup sequence described above.

NOTE: Regardless of what happens to the MPFICQor's hold-up voltage under a brownout or dropout condition, if the AC source voltage drops below its rated under-voltage value for 1 second or more, the MPFICQor will shut down.

If, however, the voltage across the hold-up capacitor does not drop below its specified minimum limit before the AC source voltage returns to within its continuous operating range (and it hasn't been absent for more than 1 second), the MPFICQor will automatically re-establish its power flow. The hold-up capacitor will be recharged immediately to the peak of the AC source voltage (if it has fallen below this value) and to its nominal regulated voltage level within a few cycles of the AC source waveform.

NOTE: During the first phase where the hold-up capacitor is recharged (if this phase exists) there will be an inrush current drawn from the AC source that depends on the details of how quickly the AC source voltage returns to its normal operating condition.

Control Features

START SYNC (Pin A1):

Pin A1 is designated as START SYNC, and is only implemented on the Droop model. This pin is not used on the Regulated-output model and should be left floating when not used. In paralleled applications, connect START SYNC between multiple units to synchronize restart after a fault condition. Internal interface circuitry is shown in **Figure B**.

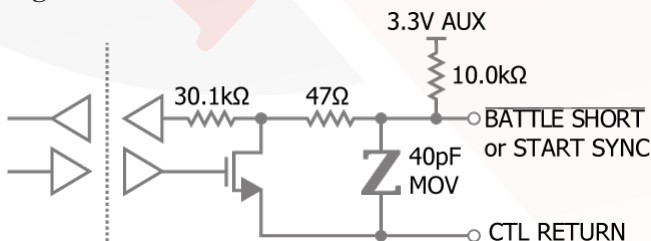

Figure B: Internal circuitry for **BATTLE SHORT** and **START SYNC** pins.

CTL RETURN (Pin A2):

CTL RETURN serves as the ground for all control signals. It is internal connected to VOUT- through 5Ω resistor.

SERIAL IN (Pin A3):

A wide variety of operating parameter (voltages, currents, temperatures) may be accessed via the built-in full-duplex asynchronous serial interface. Commands may be transferred to the internal DSP via the SERIAL IN pin at 9600 baud (8N1 – 8 data bits, no parity, 1 stop bit). A 'start' or 'zero' bit is encoded as a logic low. The frequency tolerance of the external interface circuit should be better than ±2% accuracy to ensure that the last bit of incoming serial data arrives within the proper frame time.

The SERIAL IN pin may be left open if unused, and will be internally pulled up to 3.3V AUX, corresponding to the 'idle' or 'stop' state. Internal circuitry is shown in **Figure C**. Direct connection may be made to an external microcontroller, but an external transceiver IC is required to shift levels and polarity to drive from a standard RS-232 port. See the separate "SynQor Single Phase Full-brick PFIC Terminal Commands" companion document for detailed syntax (available at www.synqor.com/Single Phase Full Brick PFIC Serial Interface).

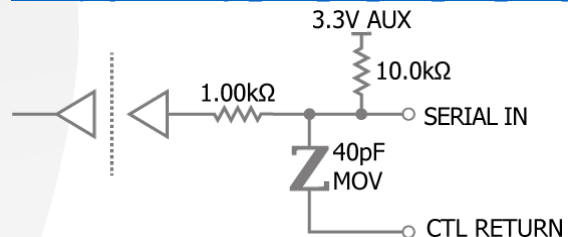

Figure C: Internal circuitry for SERIAL IN pin.

SERIAL OUT (Pin A4):

A response to each command is sent via the SERIAL OUT pin at 9600 baud (8N1 - 8 data bits, no parity, 1 stop bit). The output is low for a 'start' or 'zero' bit. When not transmitting, the output is high, corresponding to the 'idle' or 'stop' state. Internal circuitry is shown in **Figure D**. Direct connection may be made to an external microcontroller, but an external transceiver IC is required to shift levels and polarity to drive from a standard RS-232 port. See the separate "SynQor Single Phase Full-brick PFIC Terminal Commands" companion document for detailed command syntax (available at www.synqor.com/Single Phase Full Brick PFIC Serial Interface).

Application Section

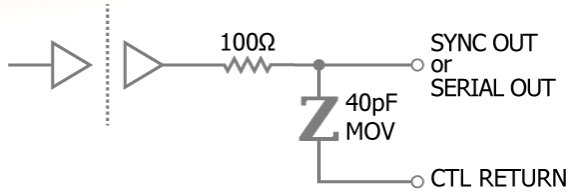

Figure D: Internal circuitry for SYNC OUT and SERIAL OUT pins.

AC GOOD (Pin A5):

Internal interface circuitry for AC GOOD is shown in Figure E.

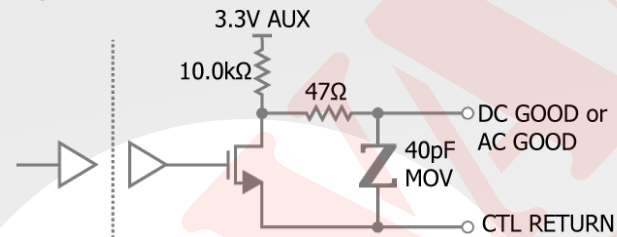

Figure E: Internal circuitry for AC GOOD and DC GOOD pins.

- The AC GOOD signal will be high whenever the AC source voltage is within the MPFICQor's continuous operating range for at least one cycle of the source waveform, regardless of whether the MPFICQor is enabled or disabled.
- When the peak of the AC source voltage is outside this continuous operating range (either too high or too low), the AC GOOD pin will be pulled low.
- The AC GOOD signal is typically used to indicate that the AC source voltage is no longer within the specified continuous operating range. The load power can only be delivered for the "hold-up time", and it may therefore be desirable to have the load gracefully shut down. The AC GOOD signal provides a warning for this action to be taken.
- When the AC source voltage returns to the specified continuous operating range, the AC GOOD signal will re-assert after a delay. The delay time is on the order of several hundreds of milliseconds. The exact timing is unspecified and varies with many factors such as input voltage, input frequency, and duration of input voltage being outside of the operating range.

DC GOOD (Pin A6):

Internal interface circuitry for DC GOOD is shown in Figure E. During start-up the positive-logic DC GOOD output will remain low until output voltage reaches its nominal value. It will remain high as long as isolation

stage is operating properly, therefore its falling threshold can be significant lower. The DC GOOD signal will usually remain high during an input power interruption. It is typically used to indicate successful startup, whereas AC GOOD is used to warn of an input power interruption.

PFC_ENA (Pin A7):

The PFC ENA pin must be brought low to enable the unit. A 10kΩ pull-up resistor is connected internally to 3.3V AUX. Therefore, if all control pins are left floating, the unit be disabled. Internal interface circuitry is shown in Figure F.

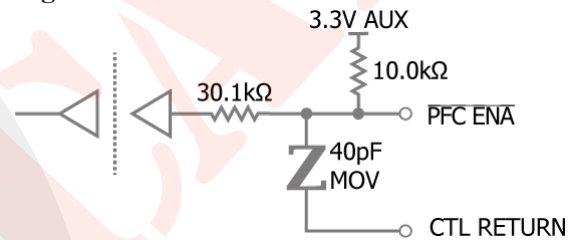

Figure F: Internal circuitry for PFC ENA pin.

BATTLE SHORT (Pin A8):

The BATTLE SHORT pin, see Figure B, is both an input and an open drain output, pulled up to 3.3V AUX through a 10kΩ resistor. Under all normal operating conditions, the MPFICQor drives/holds the BATTLE SHORT pin low. User can read this low level as an indication of normality.

If, however, the MPFICQor warms to within 5°C of over temperature shutdown, the BATTLE SHORT pin is released. Not driven, the pin will be pulled high through the pull-up resistor, and the user can read this high level as a warning of impending shutdown. If the MPFICQor continues to warm, the module will read the BATTLE SHORT pin. If it is high, the MPFICQor will shut down to protect it. If, on the other hand, the BATTLE SHORT pin is externally held low when read, the module will continue to operate, possibly to destruction.

If BATTLE SHORT action is always desired, the pin can simply be tied low.

3.3V AUX (Pin A9):

The 3.3V AUX supply (relative to CTL RETURN) can source up to 100 mA to power user loads. This independent supply is present and regulated whenever the MPFICQor's hold-up voltage is greater than approximately 75V. The 3.3V AUX supply is unspecified

Application Section

when MPFICQor's hold-up voltage is less than 75V (it may, for instance, come and go as the hold-up voltage rises on its way to 75V).

If unused, the 3.3V AUX output should be left open.

SYNC OUT (Pin A10):

The SYNC OUT pin generates a continuous series of pulses at the main switching frequency. The duty cycle is 50%. The boost and isolation stages are synchronized and switch at the same frequency. The SYNC OUT pin may be left open if not used. Internal interface circuitry is shown in **Figure D**.

Protection Features

Input Over- and Under-Voltage:

If the AC source voltage exceeds the maximum peak voltage rating defined in the Electrical Specifications, the MPFICQor will shut down. However, under this condition the MPFICQor's pre-charge circuit will continue to deliver 50mA of current to the hold-up capacitor.

If a brownout or dropout of the AC source voltage occurs, and if it lasts long enough for the MPFICQor's hold-up voltage to drop below its specified minimum limit, the MPFICQor will shut down. Furthermore, regardless of what happens to the MPFICQor's hold-up voltage, if the AC source voltage drops below its rated under-voltage value for 1 second or more, the MPFICQor will shut down.

After any shutdown, the MPFICQor will automatically return to the beginning of the startup sequence described above.

Hold-up Over-Voltage:

If the hold-up voltage exceeds its specified maximum limit, the MPFICQor will remain active, but will stop delivering power through its main boost stage until the hold-up voltage falls below the over-voltage threshold. Under this condition, the isolation stage will remain active and provide output voltage.

Output Current Limit and Short-Circuit Shutdown:

If the MPFICQor's output is overloaded such that its output current limit becomes activated, the output voltage will fall as the excess load current discharges the hold-up capacitor. The MPFICQor will continue to deliver power into this overload condition for about 1 second, after which the unit will shut down and automatically return to the beginning of the startup sequence described above. In

above situations, both boost and isolation stage will turn off.

The MPFICQor responds to a short-circuit event by turning the isolation stage off. The output voltage of the MPFICQor will drop to zero. During the short circuit event, the boost converter will continue to run and the hold-up capacitor will remain charged. The module then enters a hiccup mode where it repeatedly turns on and off until the short-circuit condition is removed. This prevents excessive heating of the converter.

The off time during a short-circuit event is a function of input frequency. For 50/60Hz input, off time equals 25 line cycles. For example, at 60Hz, off time is:

$$T_{off(60Hz)} = \frac{25}{60} = 417ms$$

For 400Hz input, off time is 400 line cycles:

$$T_{off(400Hz)} = \frac{400}{400} = 1000ms$$

Over Temperature:

If the internal temperature of the MPFICQor reaches 125°C, the MPFICQor will turn off its boost converter and isolation stage. When the internal temperature falls below 115°C, the MPFICQor will return to the beginning of the startup sequence described above.

Energy Storage Hold-Up Capacitor

The hold-up capacitor performs two functions:

- It handles the cyclic imbalance between the flow of energy drawn from the AC source and the flow of energy delivered to the load. In doing so, the voltage across the hold-up capacitor has a ripple at a frequency twice that of the AC source voltage (e.g. 120Hz for a 60Hz input). The larger the hold-up capacitor, or the higher the frequency of the AC source, the smaller this ripple will be.
- It provides a source of energy so that the MPFICQor can continue to deliver load power during a temporary brownout or dropout of the AC source. The larger the hold-up capacitor the longer it can provide this energy. Often it will be made large enough to allow the load to be gracefully shutdown after the AC source has been outside of its normal range for a set amount of time. A typical "hold-up time" would be in the 20 ms range for a 50/60 Hz system.

The total energy stored in a hold-up capacitor having capacitance C at any given voltage V is:

$$E = \frac{1}{2}CV^2$$

Application Section

The amount of energy, ΔE , which can be drawn from this capacitor depends on the capacitor's initial voltage, V_i , and its final voltage, V_f . This energy equals the amount of power, P , which the load draw through the isolation stage from the hold-up capacitor times the length of time, Δt , which it takes for the hold-up capacitor's voltage to drop from V_i to V_f . This energy can be equated to the hold-up capacitance according to the following formula:

$$\Delta E = \frac{P}{\eta_{ISO}} \Delta t = \frac{1}{2} C (V_i^2 - V_f^2)$$

In this formula, P is the load power and $\eta_{ISO} = 95\%$ is the isolation stage efficiency. This formula can be rearranged to find the minimum required value for C to provide the hold-up time desired for a given power level.

$$C_{min} = 2 \frac{P}{\eta_{ISO}} \Delta t / (V_i^2 - V_f^2)$$

For example, if we assume $P = 600W$, $\Delta t = 20ms$, $V_i = 400V$, $V_f = 300V$, and $\eta_{ISO} = 95\%$, then we would want a hold-up capacitance of at least $360\mu F$.

NOTE: In the above example, the hold-up voltage drops by 25% at the end of brownout period. However, the output voltage will remain in regulation, see "Brownout/Dropout Sequence" section for more detail.

NOTE: The MPFICQor is able to operate with a minimum of $100\mu F$ of hold-up capacitance, but SynQor recommends at least $330\mu F$ if the power system will be required to conform to lightning surge standards. This is because the MPFICQor relies on the hold-up capacitor to absorb most of the energy from a lightning surge.

NOTE: Even though the MPFICQor limits the inrush current drawn from the AC source during its startup sequence, it will not necessarily limit this current at the end of a temporary brownout or dropout of the AC source when the hold-up capacitor's voltage has not dropped below its minimum hold-up voltage limit. In such a condition the MPFICQor will not reinitiate a startup sequence and it will therefore not limit the current flowing through it. If the peak of the AC source voltage is greater than the hold-up capacitor's voltage at the end of the brownout/dropout period, there will be a large inrush current for one half-cycle as the hold-up capacitor's voltage is charged up to the peak of the AC source voltage. The larger the hold-up capacitor, the larger this inrush current will be. To limit inrush current during this event, limit the charging current of additional hold-up capacitance with a resistor and diode as shown below.

If it is desired to have a hold-up time longer than can be achieved with the maximum specified hold-up capacitance, then the circuit shown below can be used.

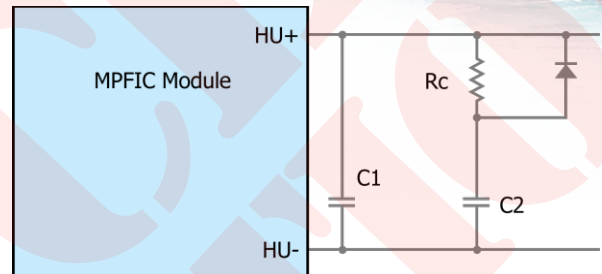

In this circuit the total hold-up capacitance is $(C1 + C2)$, and it can be made as large as desired as long as $C1$ does not exceed the maximum capacitance specified in the Technical Specifications table. The resistor, R_c , in series with $C2$ is present to limit the current that will charge this capacitor after a temporary brownout/dropout event. Its resistance should be large enough to limit the charging current. The diode in parallel with the resistor permits the load converters to draw whatever energy they need from $C2$ without being hindered by the resistor.

Output Ripple Considerations:

The hold-up capacitor must have a ripple current rating high enough to withstand the ripple current generated on the hold-up capacitor of the MPFICQor. Ripple current amplitude is dependent only upon the total MPFICQor output power, P_{DC} , isolation stage efficiency $\eta_{ISO} = 95\%$, and the operating hold-up voltage $V_{HU} = 400V$. It can be calculated using the following formula:

$$I_{Crms} = \frac{P_{DC}}{\sqrt{2} \cdot \eta_{ISO} \cdot V_{HU}} = \frac{P_{DC}}{537}$$

The AC line frequency, f_{ac} , bulk capacitance, C , operating hold-up voltage, and output power will determine the amplitude of the voltage ripple present on the output of the MPFICQor. It can be calculated with:

$$V_{pk-pk} = \frac{P_{DC}}{2\pi \cdot \eta_{ISO} \cdot f_{ac} \cdot C \cdot V_{HU}}$$

$$\text{At } 60 \text{ Hz: } V_{pk-pk} = \frac{P_{DC}}{1.43 \cdot 10^5 \cdot C}$$

For example, to calculate the hold-up capacitor's voltage and current ripple for a MPFICQor with a $600W$ output, $600\mu F$ hold-up capacitor, and a $60Hz$ fundamental AC line frequency:

$$I_{Crms} = \frac{600W}{537} = 1.1A_{rms}$$

Application Section

$$V_{pk-pk} = \frac{600W}{2\pi \cdot 0.95 \cdot 60 \cdot 600 \cdot 10^{-6}F \cdot 400V} = 7.0V_{pk-pk}$$

In this case, the hold-up capacitor would require a minimum ripple current rating of 1.1A_{rms}, and the hold-up voltage would have a pk-pk ripple voltage of 7.0V, or 1.8%. Since the isolation stage is fixed duty cycle, the secondary output voltage will also have a 1.8% ripple at 2x the line frequency.

Safety Notes

The output of the MPFICQor is isolated from the AC source. However, the hold-up voltage and the control signals are primary-side referenced and are therefore hazardous voltages. Care must be taken to avoid contact with primary-side voltages, as well as with the AC source voltage. The MPFICQor must have a fuse in series with its AC source. The rating for this fuse is given in the Technical Specification table.

MCOTS AC Line Filter

An AC line filter is needed to attenuate the differential- and common-mode voltage and current ripples created by the MPFICQor and the load, such that the system will comply with EMI requirements. The filter also provides protection for the MPFICQor from high frequency transients in the AC source voltage. SynQor has a family of AC line filters that will provide these functions. It is recommended that a metal-oxide varistor (MOV) be placed from line-to-line on the input of the filter, and a TVS diode be placed from line-to-line on the output of the filter in order to keep the MPFICQor input voltage from exceeding 450V during all transients, except when the MPFICQor is disabled, when the input can tolerate 575V transients for up to 100 ms. See **Figure A** for example parts. If a non-SynQor AC line filter is used, the use of an MOV on the input and a TVS diode on the output of the filter is still recommended.

EMI Considerations

To meet various conducted line emission standards, additional Y-capacitors may be needed to attenuate common-mode noise. SynQor recommends that safety-rated ceramic capacitors be placed from HU- to Vout- and Vout- to ground.

Thermal Consideration

The maximum operating base-plate temperature, T_B , is 100°C. Refer to the thermal derating curves to see the allowable power output for a given baseplate temperature and input voltage. A power derating curve can be calculated for any heatsink that is attached to the base-plate of the converter. It is only necessary to determine the thermal resistance, R_{THBA} , of the chosen heatsink between the base-plate and the ambient air for a given airflow rate. The following formula can then be used to determine the maximum power the converter can dissipate for a given thermal condition:

$$P_{diss}^{max} = \frac{T_B - T_A}{R_{THBA}}$$

This value of power dissipation can then be used in conjunction with the data shown in the figures to determine the maximum load power that the converter can deliver in the given thermal condition.

Paralleling Multiple MPFICQors

In higher power applications, multiple droop version units can be used in parallel. Current share is accomplished by droop sharing method.

- START SYNC should be connected in parallel between all units in the system. SERIAL IN and PFC ENA input pins may be wired in parallel. AC GOOD and DC GOOD output pins may be wired in parallel.
- BATTLE SHORT pins should not be interconnected between units. If the protection-warning output function is used, then individual signals should be combined using an OR gate. If the protection-disable input function is used, then a separate pull-down transistor should be used for each unit. If the signal is not used, it may be left open.
- The 3.3V AUX outputs could be paralleled, but total current drawn should not exceed the rating of a single unit. SYNC OUT pins should not be connected between units.

Operation at High Input Voltages

If the AC input voltage exceeds about 250 Vrms, both the hold-up voltage and output voltage may be raised up in order to maintain proper input current power factor correction. Output voltage can increase by up to 10% from the nominal output set point as input voltage increases from 250 Vrms to 264 Vrms. Refer to figure section for “Vout vs. Vin” chart under various conditions.

Encased Mechanical

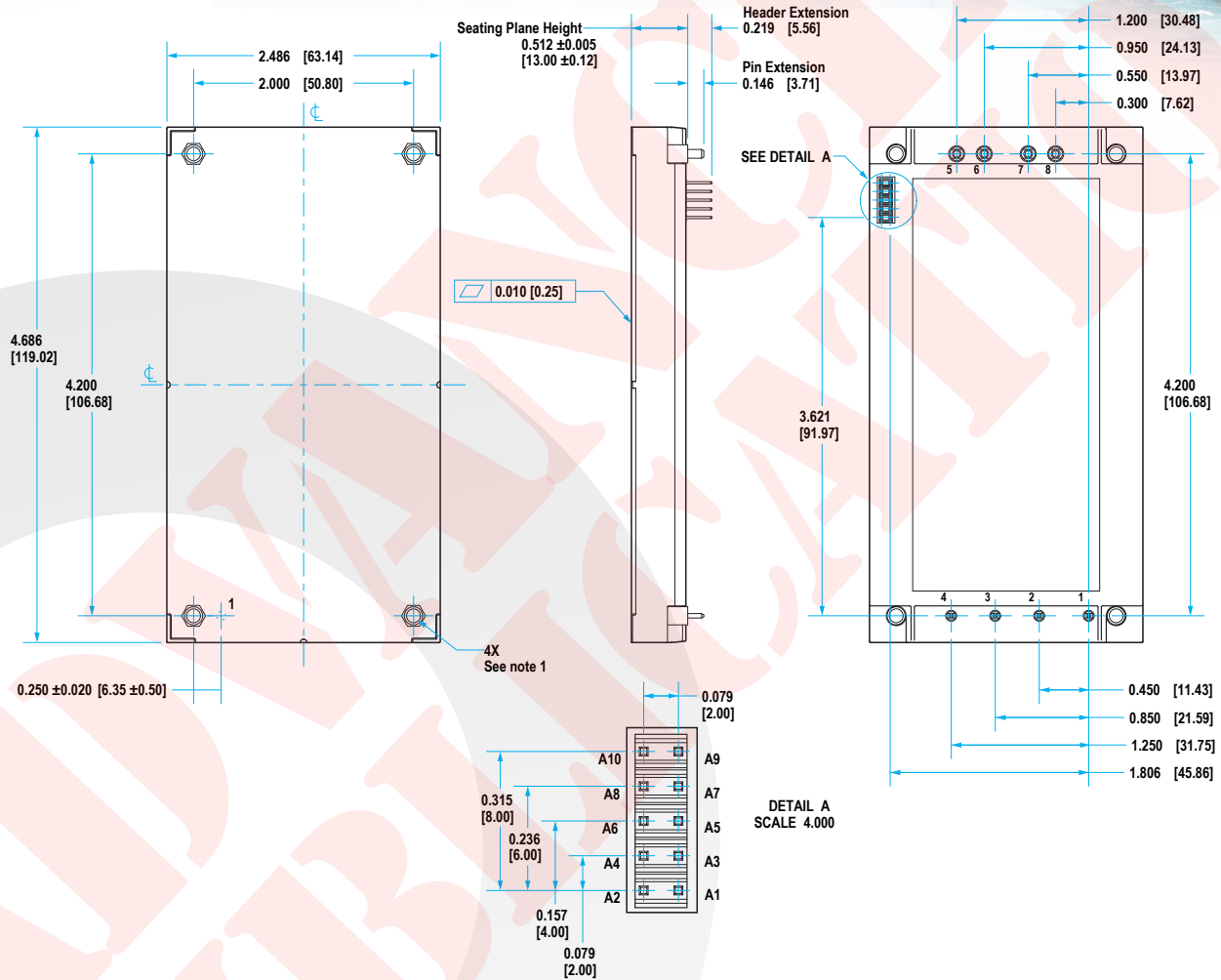

NOTES

- 1) APPLIED TORQUE PER M3 SCREW SHOULD NOT EXCEED 6in-lb. (0.7 Nm).
- 2) BASEPLATE FLATNESS TOLERANCE IS 0.010" (.25 mm) TIR FOR SURFACE
- 3) PINS 1-4 ARE 0.040" (1.02 mm) DIA. WITH 0.080" (2.03 mm) DIA.

STANDOFF SHOULDERS.

MATERIAL: COPPER ALLOY. FINISH: MATTE TIN OVER NICKEL PLATE.

- 4) PINS 5-8 ARE 0.080" (2.03 mm) DIA. WITH 0.125" (3.18 mm) DIA.

STANDOFF SHOULDERS.

MATERIAL: COPPER ALLOY. FINISH: MATTE TIN OVER NICKEL PLATE.

- 5) PINS A1-A10 ARE 0.020" X 0.020" (0.5mm X 0.5 mm)
MATERIAL: PHOSPHOR BRONZE. FINISH: GOLD FLASH OVER NICKEL UNDERPLATING

- 6) UNDIMENSIONED COMPONENTS ARE SHOWN FOR VISUAL REFERENCE ONLY

- 7) WEIGHT: 11.3oz (320g)

- 8) THREADED AND NON-THREADED OPTIONS AVAILABLE

- 9) ALL DIMENSIONS ARE IN INCHES (mm).

TOLERANCES:

X.XX +/-0.02 in. (x.x +/-0.5mm)

X.XXX +/-0.010 in. (x.xx +/-0.25mm)

- 10) WORKMANSHIP: MEETS OR EXCEEDS IPC-A-610C CLASS II

PIN DESIGNATIONS

Pin	Name	Function
1	L1	AC Line 1
2	L2/N	AC Line 2 / Neutral
3	HU+	Positive Hold-up Voltage
4	HU-	Negative Hold-up Voltage
5	VOUT-	Negative Output Voltage
6	VOUT-	Negative Output Voltage
7	VOUT+	Positive Output Voltage
8	VOUT+	Positive Output Voltage
A1	RESERVED	No Function (Regulated Output)
	START SYNC	Startup Synchronization (Droop Sharing)
A2	CTL RETURN	Control Ground for A1-A10, Internally Connected to VOUT-
A3	SERIAL IN	Serial Data Input (High = Stop/Idle)
A4	SERIAL OUT	Serial Data Output (High = Stop/Idle)
A5	AC GOOD	AC Power Good Output (High = Good)
A6	DC GOOD	DC Power Good Output (High = Good)
A7	PFC ENA	Pull Low to Enable Unit
A8	BATTLE SHORT	Pull Low to Disable OTP
A9	3.3V AUX	3.3V @ 100mA Always-On Power Output
A10	SYNC OUT	Switching Frequency Synchronization Output

Encased Mechanical with Flange

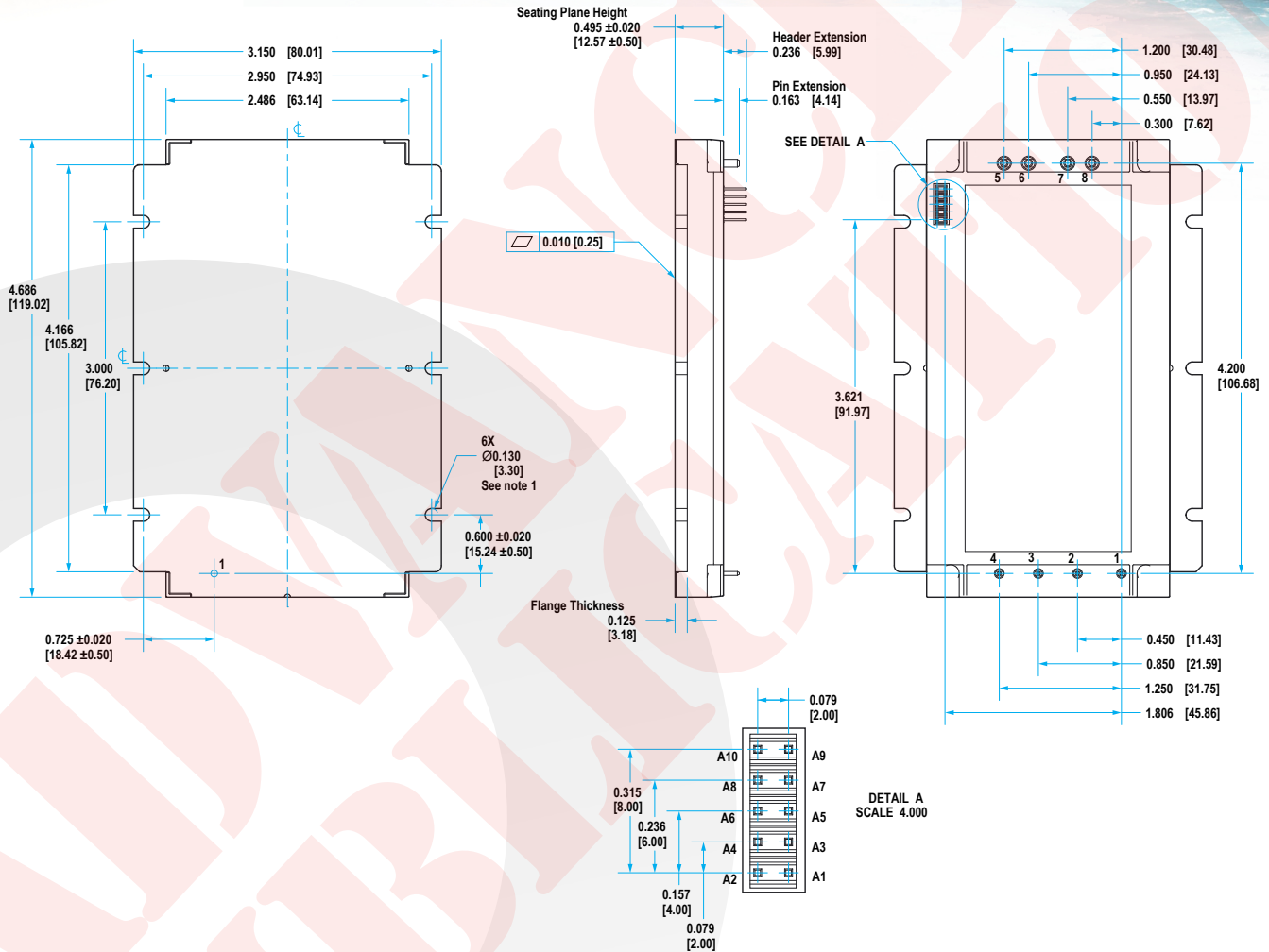

NOTES

- 1) APPLIED TORQUE PER M3 SCREW SHOULD NOT EXCEED 6in-lb. (0.7 Nm).
- 2) BASEPLATE FLATNESS TOLERANCE IS 0.010" (.25 mm) TIR FOR SURFACE
- 3) PINS 1-4 ARE 0.040" (1.02 mm) DIA. WITH 0.080" (2.03 mm) DIA.

STANDOFF SHOULDERS.

MATERIAL: COPPER ALLOY. FINISH: MATTE TIN OVER NICKEL PLATE.

- 4) PINS 5-8 ARE 0.080" (2.03 mm) DIA. WITH 0.125" (3.18 mm) DIA. STANDOFF SHOULDERS.

MATERIAL: COPPER ALLOY. FINISH: MATTE TIN OVER NICKEL PLATE.

- 5) PINS A1-A10 ARE 0.020" X 0.020" (0.5mm X 0.5 mm) MATERIAL: PHOSPHOR BRONZE. FINISH: GOLD FLASH OVER NICKEL UNDERPLATING

- 6) UNDIMENSIONED COMPONENTS ARE SHOWN FOR VISUAL REFERENCE ONLY

- 7) WEIGHT: 11.7oz (332g)

- 8) THREADED AND NON-THREADED OPTIONS AVAILABLE

- 9) ALL DIMENSIONS ARE IN INCHES (mm).

TOLERANCES:

X.XX +/-0.02 in. (x.x +/-0.5mm)

X.XXX +/-0.010 in. (x.xx +/-0.25mm)

- 10) WORKMANSHIP: MEETS OR EXCEEDS IPC-A-610C CLASS II

PIN DESIGNATIONS

Pin	Name	Function
1	L1	AC Line 1
2	L2/N	AC Line 2 / Neutral
3	HU+	Positive Hold-up Voltage
4	HU-	Negative Hold-up Voltage
5	VOUT-	Negative Output Voltage
6	VOUT-	Negative Output Voltage
7	VOUT+	Positive Output Voltage
8	VOUT+	Positive Output Voltage
A1	RESERVED	No Function (Regulated Output)
	START SYNC	Startup Synchronization (Droop Sharing)
A2	CTL RETURN	Control Ground for A1-A10, Internally Connected to VOUT-
A3	SERIAL IN	Serial Data Input (High = Stop/Idle)
A4	SERIAL OUT	Serial Data Output (High = Stop/Idle)
A5	AC GOOD	AC Power Good Output (High = Good)
A6	DC GOOD	DC Power Good Output (High = Good)
A7	PFC ENA	Pull Low to Enable Unit
A8	BATTLE SHORT	Pull Low to Disable OTP
A9	3.3V AUX	3.3V @ 100mA Always-On Power Output
A10	SYNC OUT	Switching Frequency Synchronization Output



MPFIC-U-55-FG
Input: 85-264Vrms
Output: 55Vdc
Current: 10.9A

Ordering Information

Ordering Information / Part Numbering Scheme

Family	Input Voltage	Output Voltage	Package Size	Thermal Design	Screening Level	Option
MPFIC	U: 85-264V	55: 55V	FG: Full-brick Giga	N: Encased D: Encased with Non-threaded Baseplate F: Encased with Flanged Baseplate	S: S-Grade M: M-Grade	H: Regulated Holdup DH: Droop Holdup

Example: MPFIC-U-55-FG-N-M-H

PART NUMBERING SYSTEM

The part numbering system for SynQor's ac-dc converters follows the format shown in the example.

APPLICATION NOTES

A variety of application notes and technical white papers can be downloaded in pdf format from our website.

STANDARDS COMPLIANCE (Pending)

Input to output isolation 4250Vdc	Reinforced Insulation
Input/Output to baseplate isolation 2500Vdc	Basic Insulation to Baseplate
CE Marked	

Note: An external input fuse must always be used to meet these safety requirements.

Contact SynQor for official safety certificates on new releases or download from the SynQor website.

Contact SynQor for further information and to order:

Phone: 978-849-0600
Toll Free: 888-567-9596
Fax: 978-849-0602
E-mail: power@synqor.com
Web: www.synqor.com
Address: 155 Swanson Road
 Boxborough, MA 01719
 USA

PATENTS

SynQor holds numerous U.S. patents, one or more of which apply to most of its power conversion products. Any that apply to the product(s) listed in this document are identified by markings on the product(s) or on internal components of the product(s) in accordance with U.S. patent laws. SynQor's patents include the following:

6,896,526	6,927,987	7,050,309	7,085,146
7,765,687	7,787,261	8,149,597	8,644,027

WARRANTY

SynQor offers a two (2) year limited warranty. Complete warranty information is listed on our website or is available upon request from SynQor.