

# SynQor®

## MCOTS-C-270F-3R3S-DM

### Single Output Demi-brick

## MILITARY COTS DC-DC CONVERTER

<b>200-300 V</b> Continuous Input	<b>200-350 V</b> Transient Input	<b>3.3 V</b> Output	<b>15 A</b> Output	<b>85% @ 7.5 A / 86% @ 15 A</b> Efficiency
--------------------------------------	-------------------------------------	------------------------	-----------------------	-----------------------------------------------

The Mil-COTS DC-DC Converters bring SynQor's field proven high-efficiency synchronous rectification technology to the Military/Aerospace industry. SynQor's ruggedized encased packaging approach ensures survivability in demanding environments. These converters operate at a fixed frequency and follow conservative component derating guidelines. They are designed and manufactured to comply with a wide range of military standards.

## MilCOTS™



### Safety Features

- 4250 V, 100 MΩ input-to-output isolation
- Certified 62368-1 requirement for basic insulation (see Standards and Qualifications page)

### Mechanical Features

- Demi-brick Pin-out configuration
- Size: 1.55" x 1.52" x 0.50" (39.4 x 38.6 x 12.7 mm)
- Total weight: 1.97 oz. (56 g)
- Flanged baseplate version available

### Control Features

- On/Off control referenced to input return
- Remote sense for the output voltage
- Output voltage trim range of +10%, -10%

### Compliance Features

- MilCOTS series converters (With an MCOTS filter) are designed to meet:
- MIL-HDBK-704-7 (E-F)
  - MIL-STD-461 (C, D, E, F)

### Operational Features

- High efficiency, 86% at full rated load current
- Operating input voltage range: 200-300 V
- Fixed frequency switching to provide predictable EMI
- No minimum load requirement

### Protection Features

- Input under-voltage and over-voltage lockout
- Output current limit and short circuit protection
- Active back bias limit
- Output over-voltage protection
- Thermal shutdown

### Screening/Qualification

- AS9100 & ISO 9001 certified facility
- Qualified to MIL-STD-810
- Available with S-Grade or M-Grade screening
- Temperature cycling per MIL-STD-883, Method 1010, Condition B, 10 cycles
- Burn-In at 100 °C baseplate temperature
- Final visual inspection per MIL-STD-883, Method 2009
- Full component traceability



## Block Diagram

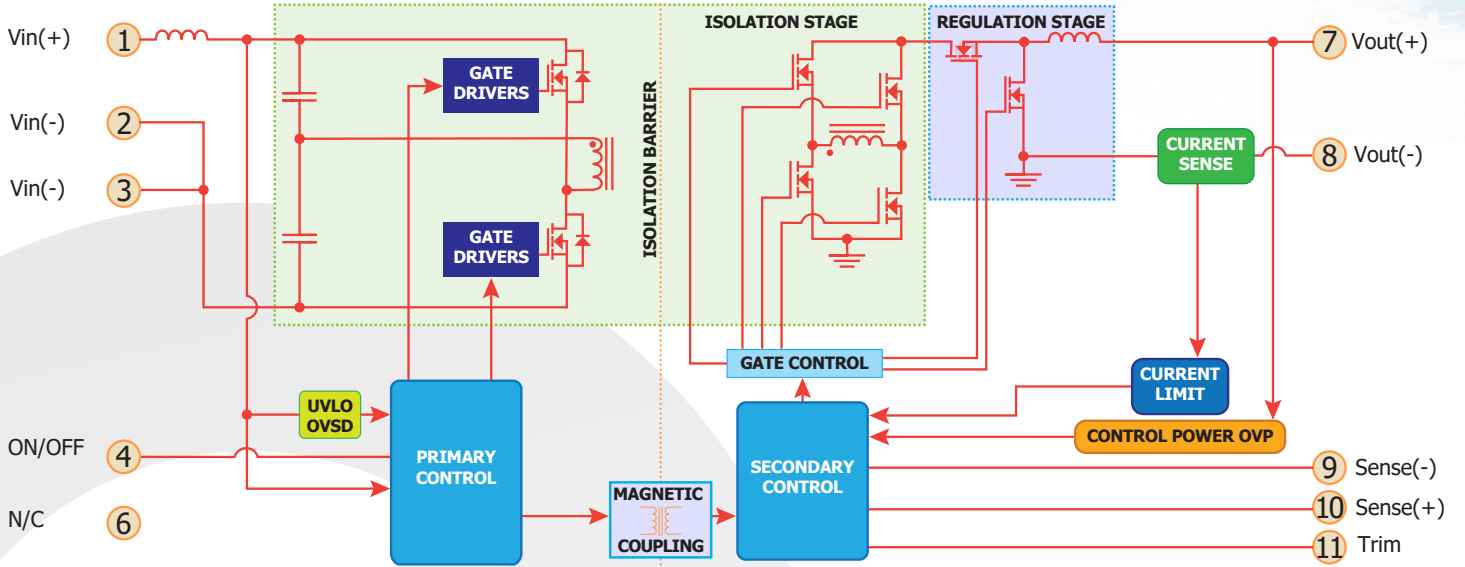

## Typical Connection Diagram

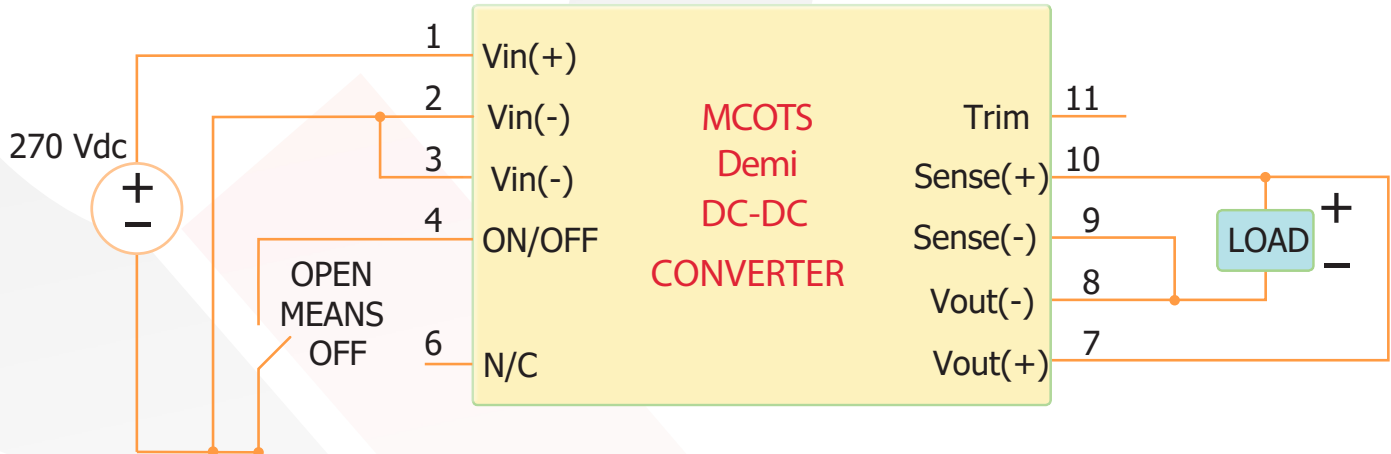



# Electrical Characteristics

## MCOTS-C-270F-3R3S-DM ELECTRICAL CHARACTERISTICS

Tb = 25 °C, Vin = 270 Vdc, full load unless otherwise noted; full operating temperature range is -55 °C to +100 °C baseplate temperature with appropriate power derating. Specifications subject to change without notice.

Parameter	Min.	Typ.	Max.	Units	Notes & Conditions
<b>ABSOLUTE MAXIMUM RATINGS</b>					
Input Voltage					
Non-Operating	-1		500	V	Continuous
Operating			300	V	Continuous
Operating Transient Protection			350	V	100 ms transient, square wave
Isolation Voltage					
Input to Output			4250	V	Reinforced Insulation
Input to Baseplate			2300	V	Basic Insulation
Output to Baseplate			2300	V	Basic Insulation
Operating Case Temperature	-55		100	°C	Baseplate temperature
Storage Case Temperature	-65		135	°C	
Voltage at ON/OFF input pin	-1.2		50	V	
<b>INPUT CHARACTERISTICS</b>					
Operating Input Voltage Range	200	270	300	V	350 V transient for 100 ms; see Notes 1, 5, 8 & 9
Input Under-Voltage Turn-On Threshold	189	193	197	V	See Note 3
Input Under-Voltage Turn-Off Threshold	182	187	190	V	See Note 3
Input Under-Voltage Shutdown Hysteresis		6.0		V	
Input Over-Voltage Turn-Off Threshold	312	315	320	V	See Note 3
Input Over-Voltage Turn-On Threshold	300	307	310	V	See Note 3
Input Over-Voltage Shutdown Hysteresis		8.0		V	
Recommended External Input Capacitance		4.7		µF	Typical ESR 8Ω see Note 8
Input Filter Component Values (L\C)		4.7\0.7		µH\µF	Internal values; see Figure D
Maximum Input Current			0.33	A	Vin = 200 V; Iout = 15 A
No Load Input Current		11	13	mA	
Disabled Input Current		2	5	mA	
Input Terminal Current Ripple (rms)		20		mA	Bandwidth = 100 kHz – 10 MHz; see Figure 17
Recommended Input Fuse			10	A	Fast acting external fuse recommended
<b>OUTPUT CHARACTERISTICS</b>					
Output Voltage Set Point	3.267	3.30	3.333	V	Vout at sense leads
Output Voltage Regulation				mV	
Over Line	-0.3		0.3	%	
Over Load	-0.3		0.3	%	
Over Temperature	-50		50	mV	
Total Output Voltage Range	3.23	3.30	3.37	V	Over sample, line, load, temperature & life
Output Voltage Ripple and Noise (Peak to Peak)		35	100	mV	Bandwidth = 20 MHz; CL=11 µF
Output Voltage Ripple and Noise (rms)		15	30	mV	Bandwidth = 20 MHz; CL=11 µF
Operating Output Current Range			15	A	
Operating Output Power Range			50	W	
Output DC Current-Limit Inception	16.5	18.0	20.0	A	
Back-Drive Current Limit while Enabled		2.3		A	
Back-Drive Current Limit while Disabled		10		mA	
Maximum Output Capacitance			5000	µF	
Output Voltage Deviation Load Transient					See Note 4
For a Pos. Step Change in Load Current		-600		mV	
Settling Time		400		µs	
Response to Input Transient		400		mV	See Figure 12, see Note 5
Output Voltage Trim Range	-10		10	%	See Figure B
Output Over-Voltage Shutdown	3.9	4.1	4.2	V	
<b>EFFICIENCY</b>					
Iout = 15 A (270 Vin)		86		%	
Iout = 7.5 A (270 Vin)		85		%	



**MCOTS-C-270F-3R3S-DM**  
**Input: 200-300 V**  
**Output: 3.3 V**  
**Current: 15 A**

## Electrical Characteristics

### MCOTS-C-270F-3R3S-DM ELECTRICAL CHARACTERISTICS (Continued)

Tb = 25 °C, Vin = 270 Vdc, full load unless otherwise noted; full operating temperature range is -55 °C to +100 °C baseplate temperature with appropriate power derating. Specifications subject to change without notice.

Parameter	Min.	Typ.	Max.	Units	Notes & Conditions
<b>ISOLATION CHARACTERISTICS</b>					
Isolation Voltage (dielectric strength)					See Absolute Maximum Ratings
Isolation Resistance		100		MΩ	
Isolation Capacitance (input to output)			NA	nF	See Note 7
<b>TEMPERATURE LIMITS FOR POWER DERATING CURVES</b>					
Semiconductor Junction Temperature			125	°C	Package rated to 150 °C
Board Temperature			125	°C	UL rated max operating temp 130 °C
Transformer Temperature			125	°C	
Maximum Baseplate Temperature, Tb			100	°C	
<b>FEATURE CHARACTERISTICS</b>					
Switching Frequency	395	400	407	kHz	Isolation stage switching freq. is half this
ON/OFF Control					
Off-State Voltage	2			V	
Module Off Pulldown Current	80			μA	Current drain required to ensure module is off
On-State Voltage			0.8	V	
Module On Pin Leakage Current			20	μA	Imax draw from pin allowed with module still on
Pull-Up Voltage	3.2	4.0	4.8	V	See Figure A
<b>DYNAMIC CHARACTERISTICS</b>					
Turn-On Transient					
Output Voltage Rise Time		130	160	ms	Vout = 0.33 V to 2.97 V; Full Resistive Load
Output Voltage Overshoot		0	2	%	Resistive load
Turn-On Delay, Rising Vin		35	50	ms	On/Off = 5 V; see Notes 6 & 2
Turn-On Delay, Rising ON/OFF		2.0	6.0	ms	See Note 2
Restart Inhibit Time		400		ms	See Note 2
<b>RELIABILITY CHARACTERISTICS</b>					
Calculated MTBF per MIL-HDBK-217F		1.2		10 <sup>6</sup> Hrs.	Ground Benign, 70 °C Tb
Calculated MTBF per MIL-HDBK-217F		0.147		10 <sup>6</sup> Hrs.	Ground Mobile, 70 °C Tb

#### Electrical Characteristics Notes

1. Converter will undergo input over-voltage shutdown.
2. After a disable or fault event, module is inhibited from restarting for 400 ms. See Shut Down section of the Control Features description.
3. High or low state of input voltage must persist for about 200 μs to be acted on by the shutdown circuitry.
4. Load current transition time ≥ 10 μs.
5. Line voltage transition time ≥ 100 μs.
6. Input voltage rise time ≥ 250 μs.
7. Isolation capacitance can be added external to the module.
8. An input capacitor with series resistance is necessary to provide system stability.
9. Converter will undergo an immediate input over-voltage shutdown beyond a typical value of 370 V.



## Technical Charts

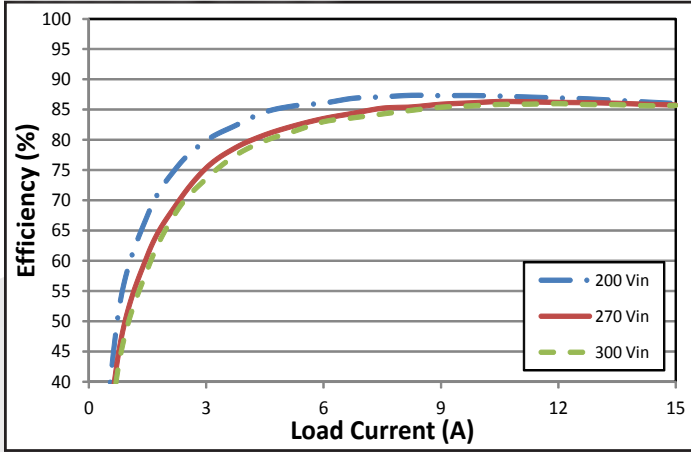

Figure 1: Efficiency at nominal output voltage vs. load current for minimum, nominal, and maximum input voltage at 25 °C.

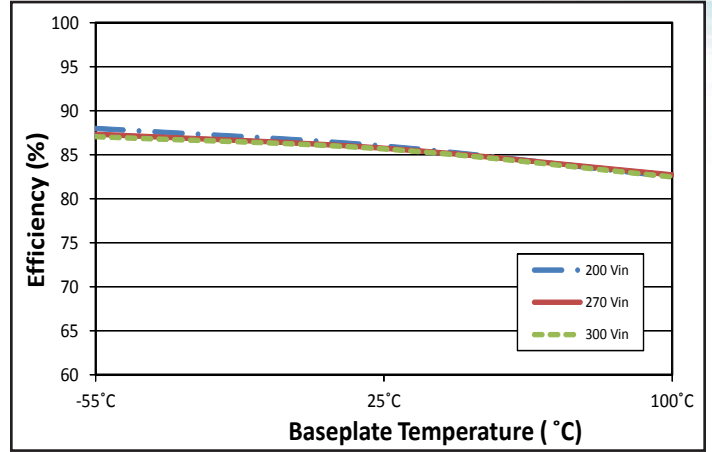

Figure 2: Efficiency at nominal output voltage and 100% rated power vs. case temperature for minimum, nominal, and maximum input voltage.

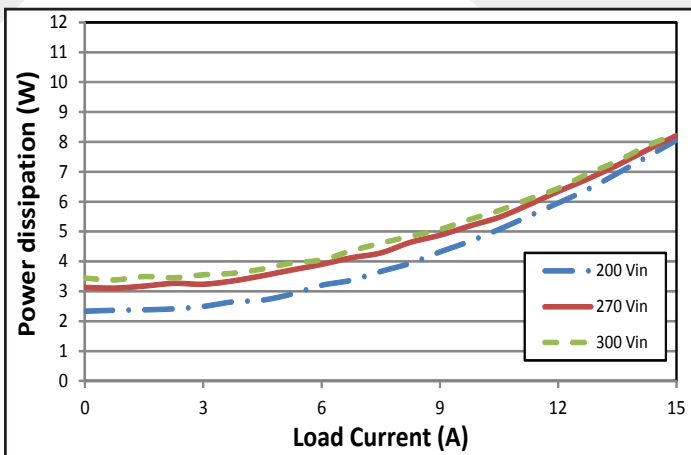

Figure 3: Power dissipation at nominal output voltage vs. load current for minimum, nominal, and maximum input voltage at 25 °C.

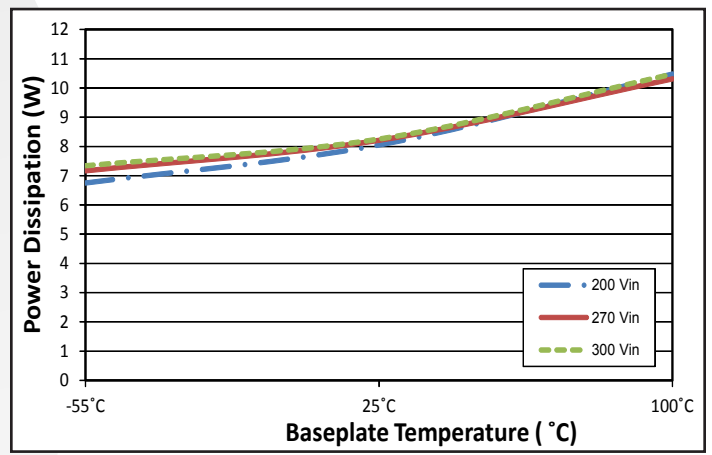

Figure 4: Power dissipation at nominal output voltage and 100% rated power vs. case temperature for minimum, nominal, and maximum input voltage

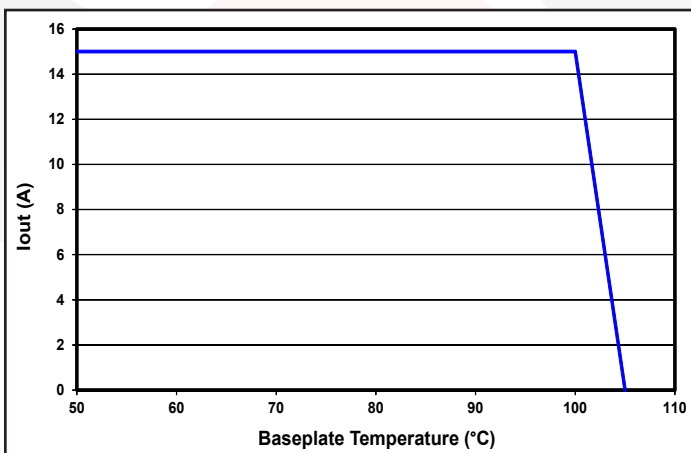

Figure 5: Maximum output current vs. baseplate temperature (nominal input voltage.)

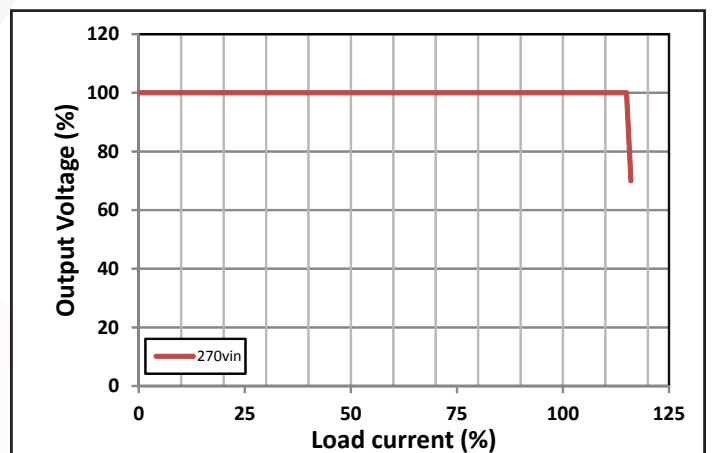
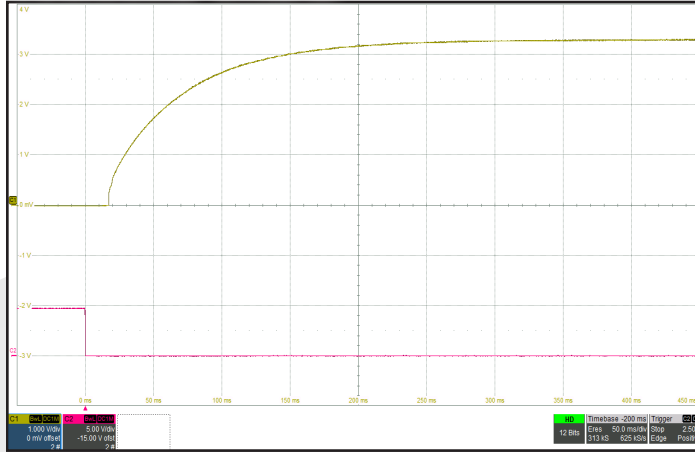

Figure 6: Output voltage vs. load current showing typical current limit curves. See Current limit section in application notes.



## Technical Charts



**Figure 7:** Turn-on transient at no load and zero output capacitance initiated by On/Off. Input voltage pre-applied. Ch 1: Vout (1 V/div). Ch 2: On/Off (5 V/div). Timescale: 50.0ms/div.

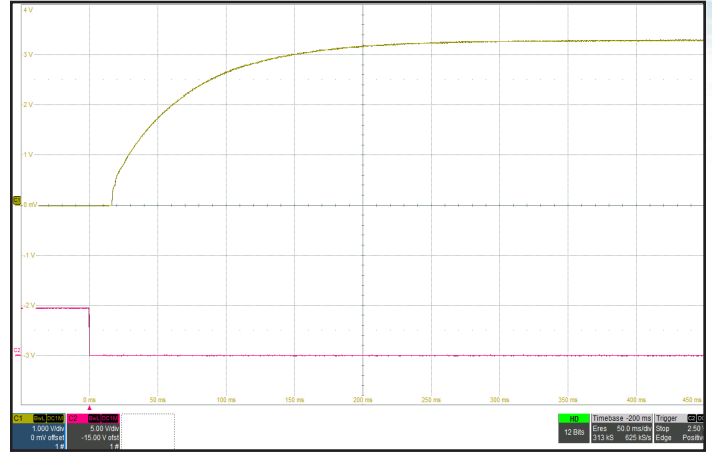

**Figure 8:** Turn-on transient at full resistive load and zero output capacitance initiated by On/Off. Input voltage pre-applied. Ch 1: Vout (1 V/div). Ch 2: On/Off (5 V/div). Timescale: 50.0ms/div.

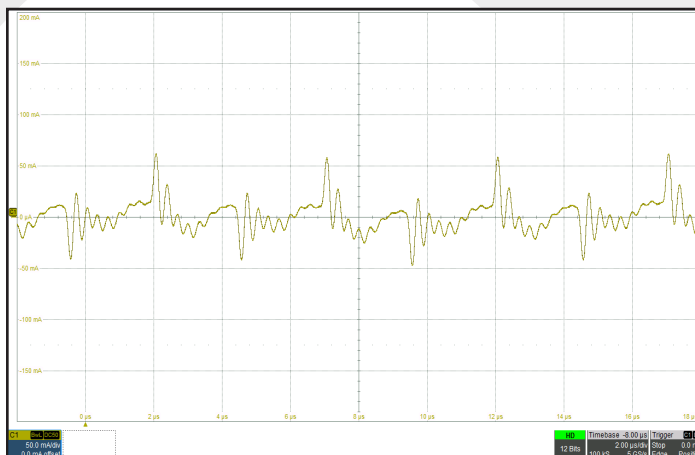

**Figure 9:** Input terminal current ripple, at full rated output current and nominal input voltage (50 mA/div). Timescale: 2.00µs/div. See Figure 17.

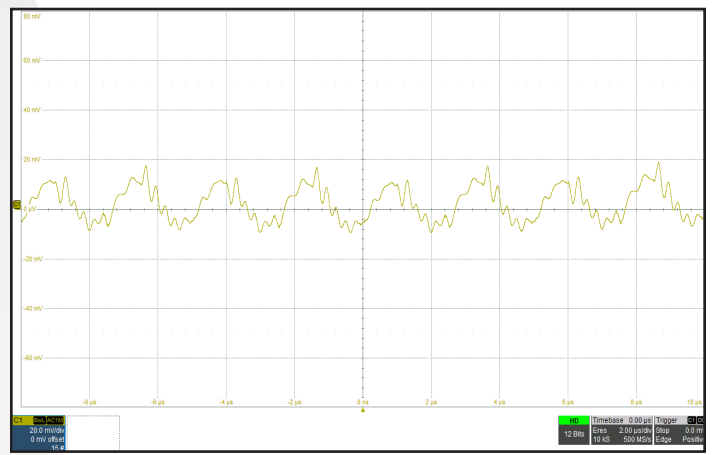

**Figure 10:** Output voltage ripple, Vout, at nominal input voltage and full rated load current (20 mV/div). Timescale: 2.00µs/div.

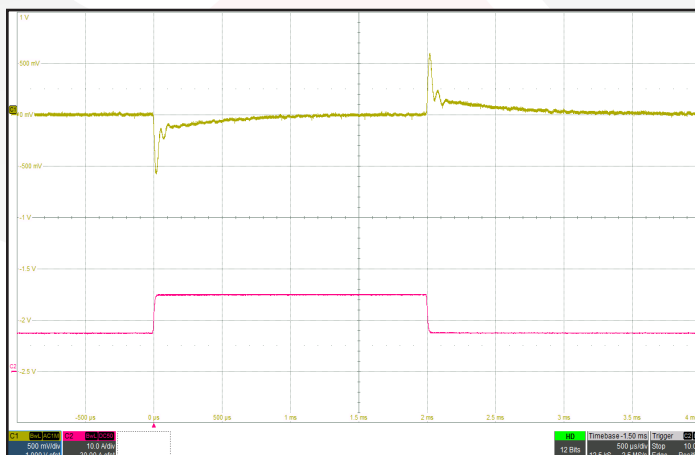

**Figure 11:** Output voltage response to step-change in load current 50%-100%-50% of Iout (max). No external load capacitance. Ch 1: Vout (500 mV/div). Ch 2: Iout (10 A/div). Timescale: 500µs/div.

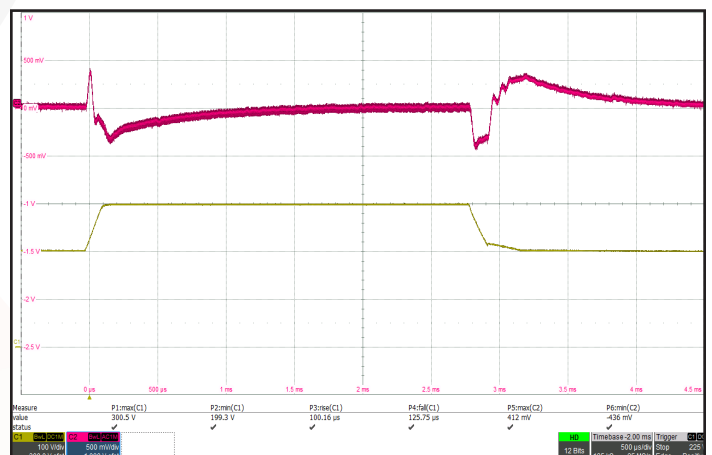

**Figure 12:** Output voltage response to step-change in input voltage (200 V - 300 V - 200 V) in 100 µs. Ch 2: Vout (500 mV/div). Ch 1: Vin (100 V/div). Timescale: 500µs/div.



## Technical Charts

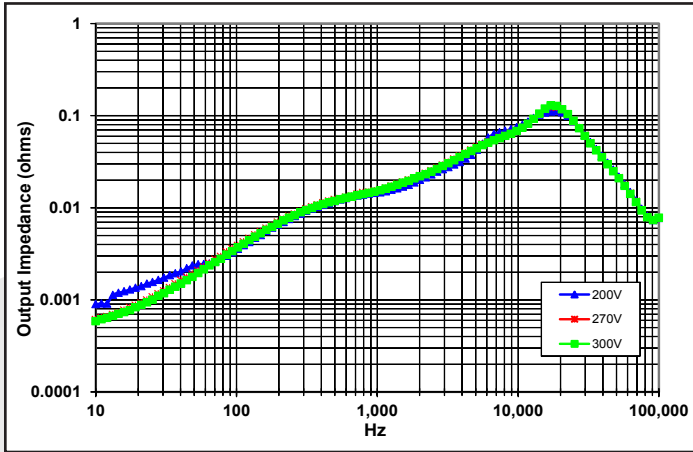

Figure 13: Magnitude of incremental output impedance ( $Z_{out} = v_{out} / i_{out}$ ) for minimum, nominal, and maximum input voltage at full rated power.

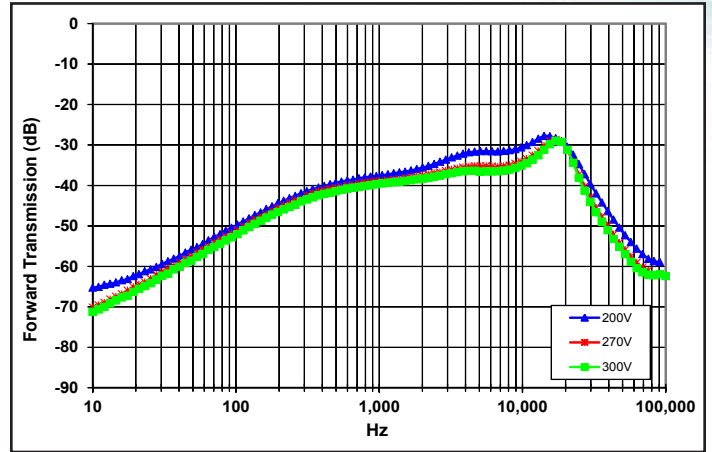

Figure 14: Magnitude of incremental forward transmission ( $FT = v_{out} / v_{in}$ ) for minimum, nominal, and maximum input voltage at full rated power.

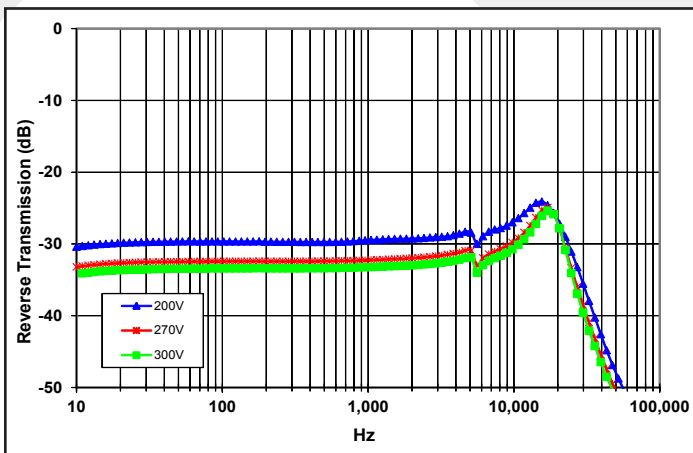

Figure 15: Magnitude of incremental reverse transmission ( $RT = i_{in} / i_{out}$ ) for minimum, nominal, and maximum input voltage at full rated power.

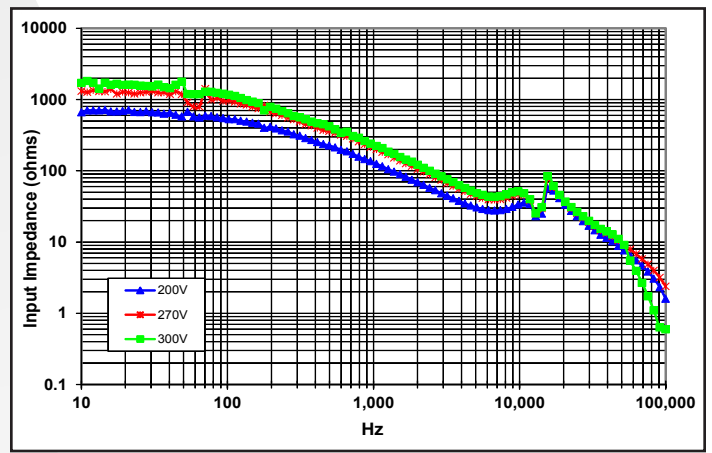

Figure 16: Magnitude of incremental input impedance ( $Z_{in} = v_{in} / i_{in}$ ) for minimum, nominal, and maximum input voltage at full rated power.

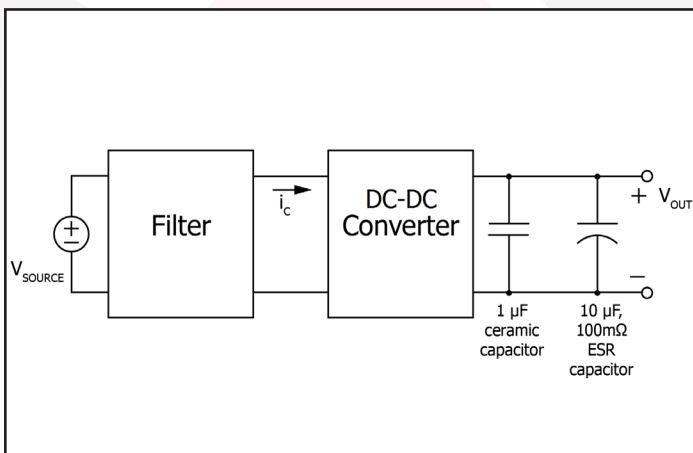

Figure 17: Test set-up diagram showing measurement points for Input Terminal Ripple Current (Figure 9) and Output Voltage Ripple (Figure 10).



Figure 18: A short circuit across the output terminals. Ch 1:  $V_{out}$  (1 V/div). Ch 2:  $I_{out}$  (10 A/div).



## Application Section

### BASIC OPERATION AND FEATURES

The MCOTS DC-DC converter uses a two-stage power conversion topology. The first, or isolation, stage uses a transformer to provide the functions of input/output isolation and voltage transformation to achieve the required output voltage. The second, or regulation, stage is a buck-converter that keeps the output voltage constant over variations in line, load, and temperature.

Both the regulation and the isolation stages switch at a fixed frequency for predictable EMI performance. The isolation stage switches at one half the frequency of the regulation stage, but due to the push-pull nature of this stage it creates a ripple at double its switching frequency. As a result, both the input and the output of the converter have a fundamental ripple frequency of about 400 kHz.

Rectification of the isolation stage's output is accomplished with synchronous rectifiers. These devices, which are MOSFETs with a very low resistance, dissipate far less energy than would Schottky diodes. This is the primary reason why the MCOTS converters have such high efficiency, particularly at low output voltages.

Besides improving efficiency, the synchronous rectifiers permit operation down to zero load current. There is no longer a need for a minimum load, as is typical for converters that use diodes for rectification. The synchronous rectifiers actually permit a negative load current to flow back into the converter's output terminals if the load is a source of short or long term energy. The MCOTS converters employ a "back-drive current limit" to keep this negative output terminal current small.

There is a control circuit in the MCOTS converter that determines the conduction state of the power switches. It communicates across the isolation barrier through a magnetically coupled device. No opto-isolators are used.

An input under-voltage shutdown feature with hysteresis is provided, as well as an input over-voltage shutdown and an output over-voltage limit. There is also an output current limit that is nearly constant as the load impedance decreases (i.e., there is not fold-back or fold-forward characteristic to the output current under this condition). When a load fault is removed, the output voltage rises exponentially to its nominal value without an overshoot.

The following sections describe the use and operation of additional control features provided by the MCOTS converter.

### CONTROL FEATURES

**Remote ON/OFF:** The MCOTS converter has one on/off function pin, ON/OFF (pin 4), which is referenced with respect to the converter's Vin(-) (pin 2). It must have a logic low level for the converter to be enabled; a logic high inhibits the converter.

The ON/OFF pin is internally pulled high so that an open connection will inhibit the converter. Figure A shows the equivalent circuit looking into the ON/OFF pin. It is TTL compatible and has hysteresis.

**SHUTDOWN:** The MCOTS converter will shut down in response to only six conditions: ON/OFF input high, Vin input below under-

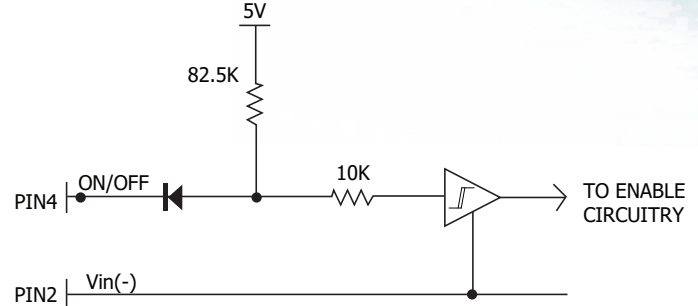

*Figure A: Circuit diagram shown for reference only, actual circuit components may differ from values shown for equivalent circuit.*

voltage shutdown threshold, Vin input above over-voltage shutdown threshold, over-temperature shutdown threshold, output voltage above the output over-voltage threshold and persistent current limit event lasting more than 20 ms. Following any shutdown event, there is a startup inhibit delay which will prevent the converter from restarting for approximately 400 ms. After the 400 ms delay elapses, if the ON/OFF input is low and the input voltage is within the operating range, the converter will restart. If the Vin input is brought down to nearly 0 V and back into the operating range, there is no startup inhibit, and the output voltage will rise according to the "Turn-On Delay, Rising Vin" specification.

**REMOTE SENSE:** The purpose of the remote sense pins is to correct for the voltage drop along the conductors that connect the converter's output to the load. To achieve this goal, a separate conductor should be used to connect the Sense(+) pin (pin 10) directly to the positive terminal of the load, as shown in the connection diagram on Page 2. Similarly, the Sense(-) pin (pin 9) should be connected through a separate conductor to the return terminal of the load.

**NOTE:** Even if remote sensing of the load voltage is not desired, the Sense(+) and the Sense(-) pins must be connected to Vout(+) (pin 7) and Vout(-) (pin 8), respectively, to get proper regulation of the converter's output. If they are left open, the converter will have an output voltage that is approximately 200 mV higher than its specified value.

Inside the converter, Sense(+) is connected to Vout(+) with a 100 Ω resistor and Sense(-) is connected to Vout(-) with a 10 Ω resistor.

It is also important to note that when remote sense is used, the voltage across the converter's output terminals (pins 7 and 8) will be higher than the converter's nominal output voltage due to resistive drops along the connecting wires. This higher voltage at the terminals produces a greater voltage stress on the converter's internal components. It may cause the converter to fail to deliver the desired output voltage at the low end of the input voltage range and at the higher end of the load current & temperature range. Please consult the factory for details.



## Application Section

**OUTPUT VOLTAGE TRIM:** The Trim pin (pin 11) can adjust the MCOTS converter's output voltage  $\pm 10\%$  around its nominal value.

To trim the output voltage above its nominal value, connect an external resistor from the Trim pin to the Sense(+) pin as shown in Figure C. The value of this trim up resistor should be chosen according to the following equation or from Figure B:

$$R_{\text{trim-up}} = \frac{5.11 V_{\text{out}} \times (100 + \Delta\%)}{1.225 \Delta\%} - \frac{511}{\Delta\%} - 10.22 \text{ (k}\Omega\text{)}$$

where:

$$\Delta\% = \left| \frac{V_{\text{nominal}} - V_{\text{desired}}}{V_{\text{nominal}}} \right| \times 100\%$$

$V_{\text{out}}$  = Nominal Output Voltage

As the output voltage is trimmed up, it produces a greater voltage stress on the converter's internal components. It may cause the converter to fail to deliver the desired output voltage at the low end of the input voltage range and at the higher end of the load current & temperature range. Please consult the factory for details. To trim the output voltage below its nominal value, connect an external resistor between the Trim pin and the Sense(-) pin. The value of this trim down resistor should be chosen according to the following equation or from Figure B:

$$R_{\text{trim-down}} = \frac{511}{\Delta\%} - 10.22 \text{ (k}\Omega\text{)}$$

**INPUT UNDER-VOLTAGE SHUTDOWN:** The MCOTS converter has an under-voltage shutdown feature that ensures the converter will be off if the input voltage is too low. The input voltage turn-on threshold is higher than the turn-off threshold. In addition, the MCOTS converter will not respond to a state of the input voltage unless it has remained in that state for more than about 200 $\mu$ s. This hysteresis and the delay ensure proper operation when the source impedance is high or in a noisy environment.

**INPUT OVER-VOLTAGE SHUTDOWN:** The MCOTS converter also has an over-voltage feature that ensures the converter will be off if the input voltage is too high. It also has a hysteresis and time delay to ensure proper operation.

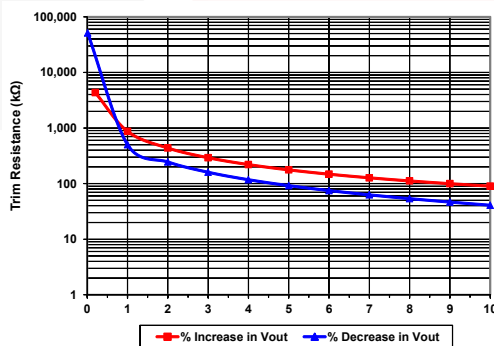

Figure B: Trim up and Trim down as a function of external trim resistance.

**OUTPUT OVER-VOLTAGE SHUTDOWN:** The MCOTS converter will shut down if the voltage at its power output pins ever exceeds about 125% of the nominal value. The shutdown threshold does not change with output trim or sense drops; excessive trim-up or output wiring drops may cause an output over-voltage shutdown event. After a startup inhibit delay, the converter will attempt to restart.

**OVER-TEMPERATURE SHUTDOWN:** A temperature sensor on the converter senses the average temperature of the module. The thermal shutdown circuit is designed to turn the converter off when the temperature at the sensed location reaches the Over-Temperature Shutdown value. It will allow the converter to turn on again when the temperature of the sensed location falls by the amount of the Over-Temperature Shutdown Restart Hysteresis value.

**BACK-DRIVE CURRENT LIMIT:** Converters that use MOSFETs as synchronous rectifiers are capable of drawing a negative current from the load if the load is a source of short- or long-term energy. This negative current is referred to as a "back-drive current".

Conditions where back-drive current might occur include paralleled converters that do not employ current sharing. It can also occur when converters having different output voltages are connected together through either explicit or parasitic diodes that, while normally off, become conductive during startup or shutdown. Finally, some loads, such as motors, can return energy to their power rail. Even a load capacitor is a source of back-drive energy for some period of time during a shutdown transient.

To avoid any problems that might arise due to back-drive current, the MCOTS converters limit the negative current that the converter can draw from its output terminals. The threshold for this back-drive current limit is placed sufficiently below zero so that the converter may operate properly down to zero load, but its absolute value (see the Electrical Characteristics page) is small compared to the converter's rated output current.

**CURRENT LIMIT:** In the event of excess load, the MCOTS converter will quickly reduce its output voltage to keep the load current within safe limits (see Figure 6). If the overload persists for more than 20 ms, the converter will shut off, wait a restart delay, and then automatically attempt to re-start. The timeout is internally implemented with an integrator: counting up whenever current limit is active, and counting down at 1/5th the rate whenever current limit becomes inactive. In this way a series of short-duration overloads will not cause the converter to shut down, while it will shut down in response to sustained overloads.



**MCOTS-C-270F-3R3S-DM**  
**Input: 200-300 V**  
**Output: 3.3 V**  
**Current: 15 A**

## Application Section

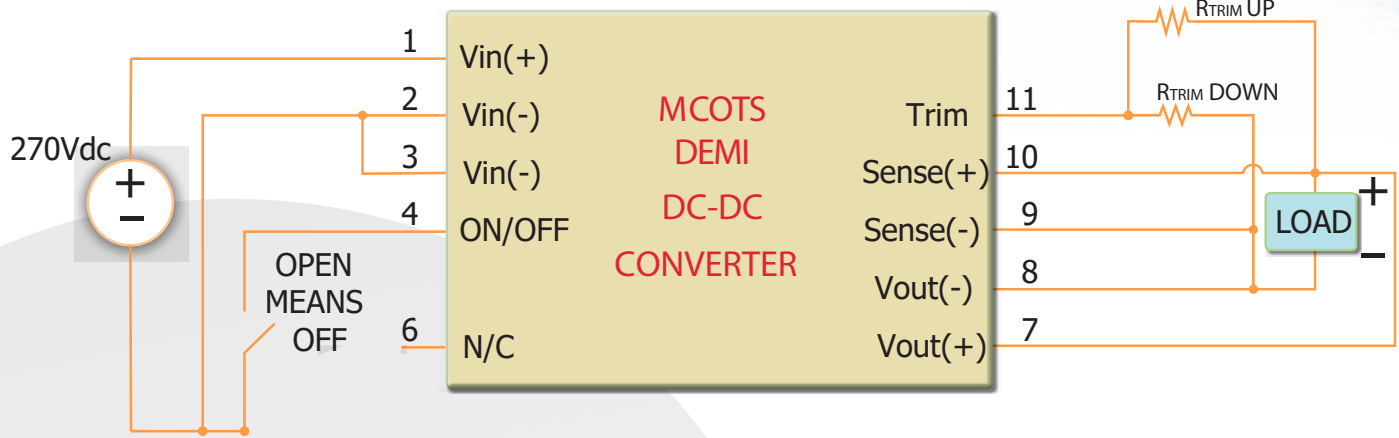

Figure C: Typical connection for output voltage trimming.

**INPUT SYSTEM INSTABILITY:** This condition can occur because any dc-dc converter appears incrementally as a negative resistance load. A detailed application note titled "Input System Instability" is available on the SynQor website which provides an understanding of why this instability arises, and shows the preferred solution for correcting it.

**THERMAL CONSIDERATIONS:** The maximum operating baseplate temperature,  $T_B$ , is 100 °C. Refer to the thermal derating curve, Figure 5, to see the available output current at baseplate temperatures below 100 °C.

A power derating curve can be calculated for any heatsink that is attached to the base-plate of the converter. It is only necessary to determine the thermal resistance,  $R_{THBA}$ , of the chosen heatsink between the base-plate and the ambient air for a given airflow rate. This information is usually available from the heatsink vendor. The following formula can then be used to determine the maximum power the converter can dissipate for a given thermal condition:

$$P_{diss}^{max} = \frac{T_B - T_A}{R_{THBA}}$$

This value of power dissipation can then be used in conjunction with the data shown in Figure 3 to determine the maximum load current (and power) that the converter can deliver in the given thermal condition.

**INPUT FILTERING AND EXTERNAL CAPACITANCE:** Figure D provides a diagram showing the internal input filter components. This filter dramatically reduces input terminal ripple current, which otherwise could exceed the rating of the converter's external electrolytic input capacitor. More detailed information is available in the application note titled "EMI Characteristics" on the SynQor website.

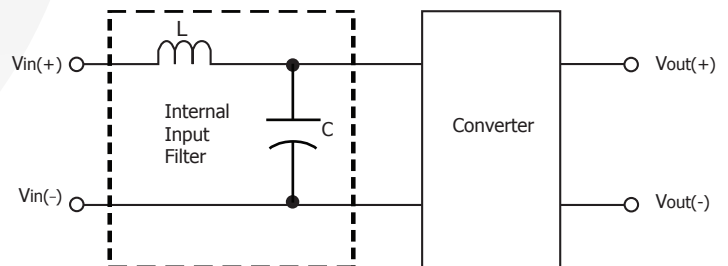
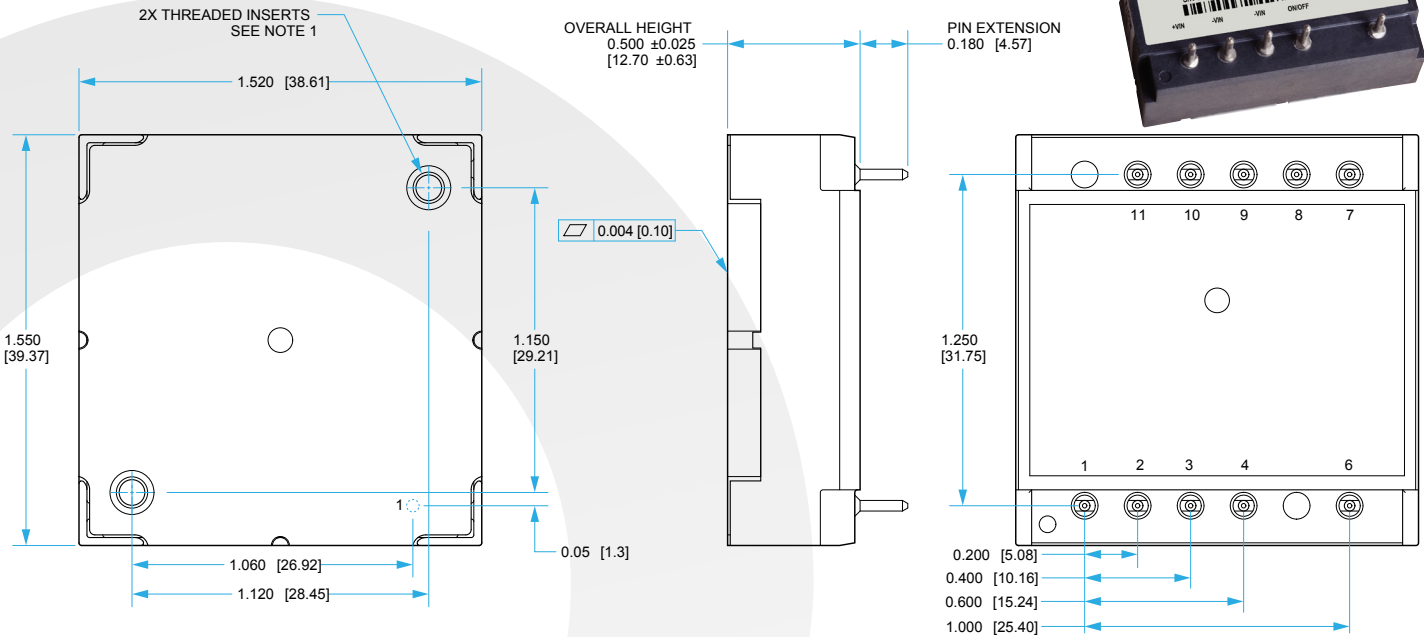

Figure D: Diagram showing the internal input filter components.



# Encased Mechanical Diagram



### NOTES:

- 1: APPLIED TORQUE PER M3 SCREW 6 in-lb (0.7 Nm) RECOMMENDED. SCREW SHOULD NOT EXCEED 0.100" (2.54 mm) DEPTH BELOW THE SURFACE OF THE BASEPLATE.
- 2: BASEPLATE FLATNESS TOLERANCE IS 0.004" (.10 mm) TIR FOR SURFACE.
- 3: PINS 1-4, 6-11 ARE .040" (1.02 mm) DIA, WITH 0.080" (2.03 mm) DIA. STANDOFF
- 4: ALL PINS: MATERIAL: COPPER ALLOY FINISH: MATTE TIN OVER NICKEL PLATE
- 5: WEIGHT: 1.97 oz. (56 g)
- 6: ALL DIMENSIONS IN INCHES(mm)  
TOLERANCES: X.XXIN +/-0.02 (X.X mm +/-0.5 mm)  
X.XXXIN +/-0.010 (X.XX mm +/-0.25 mm)

### PIN DESIGNATIONS

Pin #	Label	Name	Function
1	+VIN	Vin(+)	Positive input voltage
2	-VIN	Vin(-)	Input return
3	-VIN	Vin(-)	Input return
4	ON/OFF	ON/OFF	Turns converter on and off
6	N/C	N/C	No connection
7	+VOUT	Vout(+)	Positive output voltage
8	-VOUT	Vout(-)	Output return
9	- SNS	Sense(-)	Negative remote sense
10	+ SNS	Sense(+)	Positive remote sense
11	TRIM	Trim	Output voltage trim

Pin Designation Notes:

- 1: Pin out differs from other Mil-COTS products.



**MCOTS-C-270F-3R3S-DM**  
**Input: 200-300 V**  
**Output: 3.3 V**  
**Current: 15 A**

## Flanged Encased Mechanical Diagram

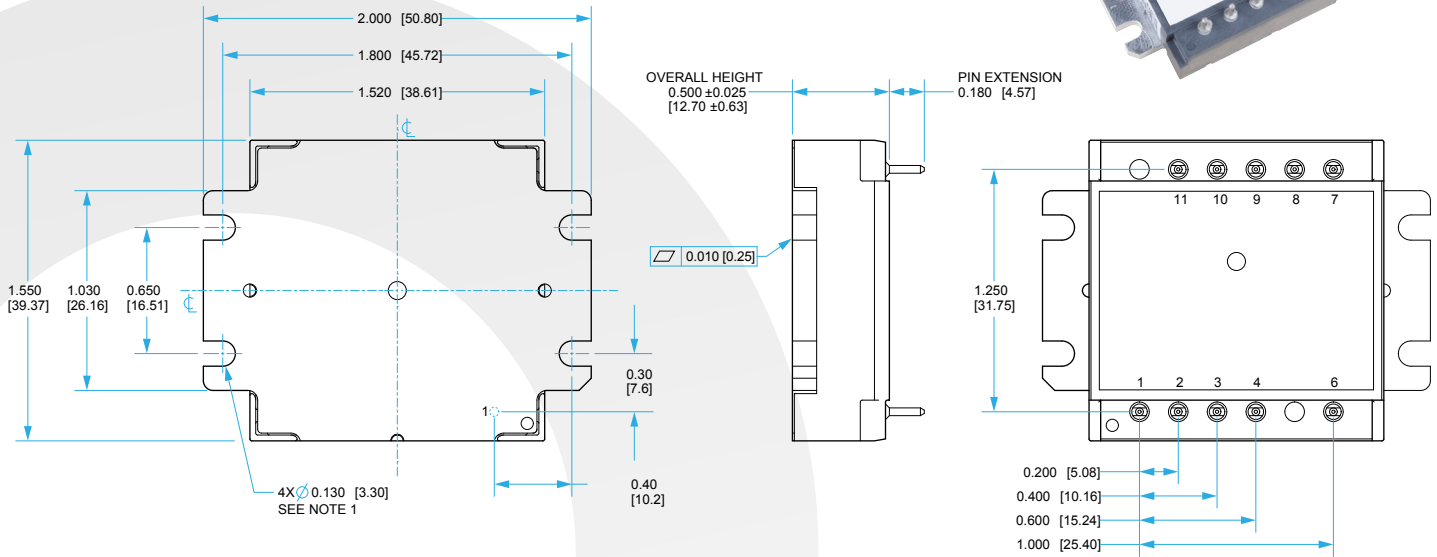
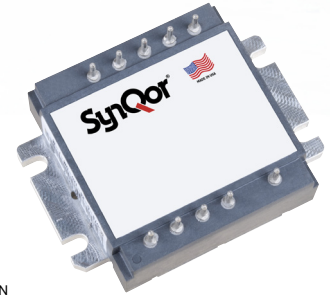

### NOTES:

- 1: APPLIED TORQUE PER M3 OR 4-40 SCREW 6 in-lb (0.7 Nm) RECOMMENDED.
- 2: BASEPLATE FLATNESS TOLERANCE IS 0.010" (.25 mm) TIR FOR SURFACE.
- 3: PINS 1-4, 6-11 ARE .040" (1.02 mm) DIA, WITH 0.080" (2.03 mm) DIA. STANDOFF
- 4: ALL PINS: MATERIAL: COPPER ALLOY FINISH: MATTE TIN OVER NICKEL PLATE
- 5: WEIGHT: 2.08 oz. (59 g)  
ALL DIMENSIONS IN INCHES(mm)
- 6: TOLERANCES: X.XXIN +/-0.02 (X.X mm +/-0.5 mm)  
X.XXXIN +/-0.010 (X.XX mm +/-0.25 mm)

### PIN DESIGNATIONS

Pin #	Label	Name	Function
1	+VIN	Vin(+)	Positive input voltage
2	-VIN	Vin(-)	Input return
3	-VIN	Vin(-)	Input return
4	ON/OFF	ON/OFF	Turns converter on and off
6	N/C	N/C	No connection
7	+VOUT	Vout(+)	Positive output voltage
8	-VOUT	Vout(-)	Output return
9	- SNS	Sense(-)	Negative remote sense
10	+ SNS	Sense(+)	Positive remote sense
11	TRIM	Trim	Output voltage trim

Pin Designation Notes:

- 1: Pin out differs from other Mil-COTS products.



**MCOTS-C-270F-3R3S-DM**  
**Input: 200-300 V**  
**Output: 3.3 V**  
**Current: 15 A**

## Qualifications & Screening

### Mil-COTS Qualification

Test Name	Details	# Tested (# Failed)	Consistent with MIL-STD-883F Method
Life Testing	Visual, mechanical and electrical testing before, during and after 1000 hour burn-in @ full load	15 (0)	Method 1005.8
Shock-Vibration	Visual, mechanical and electrical testing before, during and after shock and vibration tests	5 (0)	MIL-STD-202, Methods 201A & 213B
Humidity	+85 °C, 95% RH, 1000 hours, 2 minutes on / 6 hours off	8 (0)	Method 1004.7
Temperature Cycling	500 cycles of -55 °C to +100 °C (30 minute dwell at each temperature)	10 (0)	Method 1010.8, Condition A
Solderability	15 pins	15 (0)	Method 2003
DMT	-65 °C to +110 °C across full line and load specifications in 5 °C steps	7 (0)	
Altitude	70,000 feet (21 km), see Note	2 (0)	

Note: A conductive cooling design is generally needed for high altitude applications because of naturally poor convective cooling at rare atmospheres.

### Mil-COTS Converter and Filter Screening

Screening	Process Description	S-Grade	M-Grade
Baseplate Operating Temperature		-55 °C to +100 °C	-55 °C to +100 °C
Storage Temperature		-65 °C to +135 °C	-65 °C to +135 °C
Pre-Cap Inspection	IPC-A-610, Class III	•	•
Temperature Cycling	MIL-STD-883F, Method 1010, Condition B, 10 Cycles		•
Burn-In	100 °C Baseplate	12 Hours	96 Hours
Final Electrical Test	100%	25 °C	-55 °C, +25 °C, +100 °C
Final Visual Inspection	MIL-STD-883F, Method 2009	•	•

### Mil-COTS MIL-STD-810G Qualification Testing

MIL-STD-810G Test	Method	Description
Fungus	508.6	Table 508.6-I
Altitude	500.5 - Procedure I	Storage: 70,000 ft / 2 hr duration
	500.5 - Procedure II	Operating: 70,000 ft / 2 hr duration; Ambient Temperature
Rapid Decompression	500.5 - Procedure III	Storage: 8,000 ft to 40,000 ft
Acceleration	513.6 - Procedure II	Operating: 15 g
Salt Fog	509.5	Storage
High Temperature	501.5 - Procedure I	Storage: 135 °C / 3 hrs
	501.5 - Procedure II	Operating: 100 °C / 3 hrs
Low Temperature	502.5 - Procedure I	Storage: -65 °C / 4 hrs
	502.5 - Procedure II	Operating: -55 °C / 3 hrs
Temperature Shock	503.5 - Procedure I - C	Storage: -65 °C to 135 °C; 12 cycles
Rain	506.5 - Procedure I	Wind Blown Rain
Immersion	512.5 - Procedure I	Non-Operating
Humidity	507.5 - Procedure II	Aggravated cycle @ 95% RH (Figure 507.5-7 aggravated temp - humidity cycle, 15 cycles)
Random Vibration	514.6 - Procedure I	10 - 2000 Hz, PSD level of 1.5 g <sup>2</sup> /Hz (54.6 g <sub>rms</sub> ), duration = 1 hr/axis
Shock	516.6 - Procedure I	20 g peak, 11 ms, Functional Shock (Operating no load) (saw tooth)
	516.6 - Procedure VI	Bench Handling Shock
Sinusoidal vibration	514.6 - Category 14	Rotary wing aircraft - helicopter, 4 hrs/axis, 20 g (sine sweep from 10 - 500 Hz)
Sand and Dust	510.5 - Procedure I	Blowing Dust
	510.5 - Procedure II	Blowing Sand



**MCOTS-C-270F-3R3S-DM**  
**Input: 200-300 V**  
**Output: 3.3 V**  
**Current: 15 A**

## Ordering Information

Part Numbering Scheme							
Family	Product	Input Voltage	Output Voltage	Package Size	Heatsink Option	Screening Level	Options
<b>MCOTS</b>	<b>C:</b> Converter	<b>270F:</b> 200-300V	<b>3R3S:</b> 3.3V Single <b>05S:</b> 5.0V Single <b>12S:</b> 12V Single <b>15S:</b> 15V Single <b>28S:</b> 28V Single	<b>DM:</b> Demi Mega	<b>N:</b> Normal Threaded <b>F:</b> Flanged	<b>S:</b> S-Grade <b>M:</b> M-Grade	<b>[ ]:</b> Standard Feature

### Ordering Information / Part Numbering

Example: MCOTS-C-270F-3R3S-DM-N-S  
 Not all combinations make valid part numbers, please contact SynQor for availability.

### Application Notes

A variety of application notes and technical white papers can be downloaded in pdf format from our website.

## STANDARDS COMPLIANCE

Parameter	Notes & Conditions
<b>STANDARDS COMPLIANCE</b>	
UL 62368-1	Reinforced Insulation Input to Output
CAN/CSA-C22.2 No. 62368-1	
EN 62368-1	
Note: An external input fuse must always be used to meet these safety requirements. Contact SynQor for official safety certificates on new releases or download from the SynQor website.	

### Contact SynQor for further information and to order:

**Phone:** 978-849-0600    **Fax:** 978-849-0602  
**E-mail:** [power@synqor.com](mailto:power@synqor.com)    **Web:** [www.synqor.com](http://www.synqor.com)  
**Address:** 155 Swanson Road, Boxborough, MA 01719 USA

### WARRANTY

SynQor offers a two (2) year limited warranty. Complete warranty information is listed on our website or is available upon request from SynQor.

### PATENTS

SynQor holds numerous U.S. patents, one or more of which apply to most of its power conversion products. Any that apply to the product(s) listed in this document are identified by markings on the product(s) or on internal components of the product(s) in accordance with U.S. patent laws. SynQor's patents include the following:

7,765,687    7,787,261  
 8,149,597    8,644,027